



HÄFELE

DECORATIVE
HANDLES
AND
KNOBS
2022

UNIQUELY DESIGNED. EXCLUSIVELY HÄFELE.



Many talk about designer styles without always naming the designers. For us, names like Addison Weeks, Matthew Quinn, Ken Harroff and Belwith Keeler, mean inspired elegance which you'll only experience through the Häfele Exclusive line of handles, knobs and pulls. Each of these contemporary to transitional pieces has been meticulously crafted to be something new, entirely on trend and can only be had through Häfele.



These inspired pieces from designers based in the U.S. as well as from around the world are sure to be must-have additions to projects in kitchen, furniture, office or practically anywhere else. Matt and brushed gold or black finishes give these pieces a timelessly elegant appeal. This 70+ piece selection is available in a wide variety of lengths to accommodate an extensive range of needs.

LET THE STYLE GUIDE YOU

Style is subjective – it’s never, “one-size-fits-all.” So what you’ll find in Häfele’s 2022 Decorative Hardware catalog are chapters laid out by how we see, understand and know these amazing pieces – handles and knobs which have been selected just for you. While we may say something is Mid-Century Modern or Minimalist, you certainly don’t have to hold to those definitions or let them define your project. Either way, you should know that you’re about to take a fantastic journey in fashion and function for your cabinetry, furniture and other design adventures. The beginning of each chapter will feature Häfele exclusive deco and Häfele globally sourced products. Regardless of your selection, there are no wrong choices here.



BY HÄFELE

Inspiration can come from anywhere. How do we know this? We worked with some of the top designers in the industry to create our Häfele Exclusive range of decorative hardware – transitional to contemporary pieces which will add distinction and style to your cabinetry, furniture and spaces. U.S.-based designers contributing their work to the collection include notable industry names such as Addison Weeks, Matthew Quinn, Ken Harroff and Belwith Keeler. Their efforts help to make up these amazing 70+ handles and knobs.



BY AMEROCK

Amerock’s uncanny ability to foresee and interpret trending designs and finishes has led us to add 220 contemporary, transitional and traditional handles and matching knobs featuring on-trend finishes such as matt black, champagne bronze (gold), satin nickel and polished chrome.

HÄFELE GLOBALLY SOURCED

Supply and demand, meet Häfele. Our group subsidiaries around the world often combine to source decorative hardware so we can obtain the best pricing and materials. Our shared German quality standards ensure the products you receive from us offer finish and design consistency, as indicated by a  symbol.

NEW

Look for this symbol to find the latest additions to our decorative hardware portfolio.

ADA Items with this mark denote a piece of hardware which offers an Americans with Disabilities Act (ADA) friendly-design.

CONTENT



MID-CENTURY MODERN

Mid-Century One _____	page 3	Mid-Century Five _____	page 10
Arco _____	pages 4–5	Mid-Century Six _____	page 11
Mid-Century Two _____	page 6	Avignon _____	page 12
Mid-Century Three-Four _____	pages 7–8	Mid-Century Seven _____	pages 13–14
Aeon _____	page 9	Mid-Century Eight _____	page 15
		Aventura _____	page 16

MODERN

Modern One _____	page 19	Isabella _____	page 30
Zurich _____	page 20	Resonance _____	page 31
Manhattan _____	pages 21–22	Modern Four _____	page 32
Cube _____	page 23	Affinity _____	pages 33–34
Modern Two _____	page 24	Modern Seven _____	page 35
Neoteric _____	pages 25–27	Essential'z _____	page 36
Modern Three _____	page 28	Cyprus _____	pages 37–38
Singapore _____	page 29	Oberon _____	pages 39–40

URBAN/INDUSTRIAL

Urban One–Three _____	pages 43–45	Calypso _____	page 55
Textile/Bent _____	page 46	Metropolitan _____	page 56
Urban Four–Seven _____	pages 47–50	Roxbury _____	pages 57–58
District _____	pages 51–52	Esquire _____	pages 59–61
Urban Eight _____	page 53	Rochdale/Kontur _____	page 62
Essex _____	page 54		

ART DECO/GLAM

Art Deco/Glam One–Two _____	pages 65–66	Carrione _____	pages 73–74
Paragon _____	page 67	Glacio _____	pages 75–78
Art Deco/Glam Three _____	page 68	Abernathy _____	page 78
Zelda _____	pages 69–70	Crawford _____	pages 79–80
Art Deco/Glam Four–Five _____	page 71–72	Carolyne _____	page 81
Crystalline _____	page 72	Mulholland _____	pages 82–84
		Grace Revitalize _____	page 85
		Traditional Classics _____	page 86

TRANSITIONAL

Transitional One _____	page 89	Exceed _____	pages 101–102
Transitional Two _____	page 90	Stature _____	pages 103–104
Candler _____	pages 91–94	Surpass _____	pages 105–106
Davenport _____	pages 95–96	Extensity _____	page 107
St. Vincent _____	pages 97–98	Allison _____	page 108
Westerly _____	pages 99–100		

CONTEMPORARY

Munich _____	pages 111–112	Bar Pulls _____	pages 139–142
Contemporary One–Four _____	pages 113–116	Riva _____	page 143
Futura _____	page 117	Rift _____	page 144
Contemporary Five–Fifteen _____	pages 118–128	Caliber _____	pages 145–147
Westin _____	pages 129–130	Radius _____	pages 148–150
Contemporary Sixteen–Twenty-One _____	pages 131–136	Destine _____	pages 151–152
Tempest _____	pages 137–138	Mergence _____	pages 153–154
		Premise _____	pages 155–156
		Versa _____	pages 157–158

MINIMALIST

Spartan _____	page 161	Minimalist Two–Three _____	pages 171–172
Impressions _____	page 162	Oslo _____	pages 173–179
Venice _____	pages 163–165	Providence _____	page 180
Passages _____	pages 166–170		



ARCHITECTURAL

Architectural One _____	page 183	Architectural Five _____	page 187
Atelier _____	page 184	Architectural Six _____	page 188
Architectural Three _____	page 185	Architectural Seven _____	pages 189–190
Architectural Four _____	page 186		

FARMHOUSE

Mulberry _____	pages 193–194	Beaulieu _____	pages 198–199
Farmhouse One _____	page 195	Highland Ridge _____	pages 200–202
Farmhouse Two _____	page 196	Ashby _____	page 203
Dakota _____	page 197	Cup Pulls _____	page 204

COASTAL

Coastal One _____	page 207	Sea Grass _____	pages 209–210
Coastal Two _____	page 208		

RUSTIC

Rustic One _____	page 213	Kane _____	page 223
Rustic Two _____	page 214	Inspirations _____	pages 224–225
Arcadian _____	pages 215–216	Conrad _____	page 225
Blackrock _____	pages 217–222	Nature's Splendor _____	page 226

REVIVAL

Revival One _____	page 229	Wells _____	pages 233–234
Revitalize _____	pages 230–232		

CLASSIC

Artisan _____	pages 237–238	Blythe _____	pages 245–246
Bordeaux _____	page 239	Allison _____	page 247
Classic _____		Winsome _____	pages 248–250
One-Four _____	pages 240–243	Renown _____	pages 251–252
Granby _____	page 244		

APPLIANCE PULLS AND HOOKS

Appliance One _____	page 255	Revitalize _____	page 263
Paragon _____	page 256	Blackrock _____	page 264
Artisan/Bordeaux _____	page 257	Mulholland _____	page 265
Beaulieu/Mulberry _____	page 258	Candler _____	page 266
Arcadian _____	page 259	Westerly _____	page 267
Affinity _____	page 260	Highland Ridge _____	page 268
Appliance Three _____	page 261	Bar Pulls _____	page 269
Cyprus _____	page 262	Hooks _____	pages 271–276

THUMBNAILS & NUMERICAL INDEX

Screws/Jigs _____	pages 277–280	Numerical Index _____	pages 293–297
Thumbnails _____	pages 281–292	Finish Index _____	pages 298–311

MID-CENTURY MODERN

Eames. Jacobsen. Noguchi. Say the names and mid-century classics such as the egg chair appear. In deco, over-sized deco pulls, saucer knobs, or supple yet subtle curves define clean, asymmetrical statement pieces. Materials include golds, brushed brass and Lucite. The color palette features vivid shades of turquoise, turmeric and orange.







Mid-Century Modern

BY HÄFELE

NEW

	Finish	Material	A	C	Item No.	SRP/pc.
1	brushed nickel	Zinc	74	64	106.69.100	\$6.96
2	black brushed nickel	Zinc	74	64	106.69.320	\$7.04
3	brushed nickel	Zinc	170	160	106.69.101	\$10.26
4	black brushed nickel	Zinc	170	160	106.69.321	\$10.34
5	brushed nickel	Zinc	329	320	106.69.102	\$20.72
6	black brushed nickel	Zinc	329	320	106.69.322	\$21.14
7	antique brushed brass	Zinc	-	-	106.70.131	\$7.66
8	polished chrome	Zinc	-	-	106.70.130	\$7.20
9	brushed nickel	Zinc	-	-	106.70.135	\$10.10
10	matt gold	Zinc	-	-	106.70.136	\$11.06

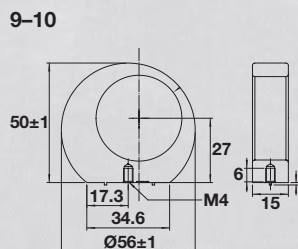
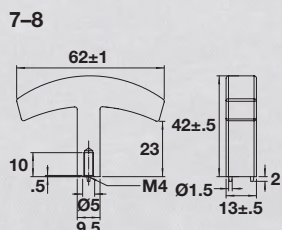
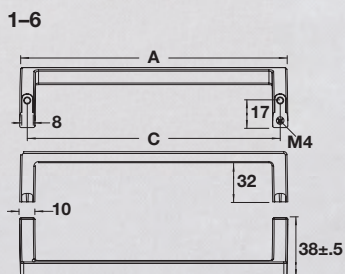



Arco NEW

BY HÄFELE

	Finish	Material	A	C	Item No.	SRP/pc.
1	polished chrome	Zinc	-	-	118.68.204	\$8.31
2	stainless steel	Zinc	-	-	118.68.104	\$8.47
3	stainless steel	Zinc	170	160	103.30.106	\$8.45
4	stainless steel	Zinc	138	128	103.30.105	\$7.67
5	polished chrome	Zinc	170	160	103.30.206	\$8.23
6	polished chrome	Zinc	138	128	103.30.205	\$7.41
7	polished chrome	Zinc	-	-	110.35.390	\$7.26
8	stainless steel	Zinc	-	-	110.35.392	\$7.42

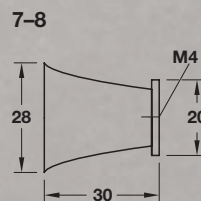
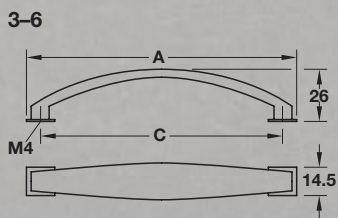
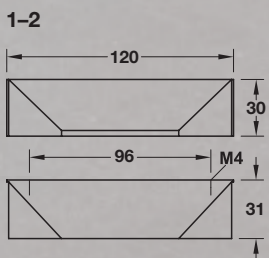

Dimensions in mm unless otherwise noted.



Arco NEW

BY HÄFELE

	Finish	Material	A	C	Item No.	SRP/pc.
1	polished nickel	Zinc	-	-	118.68.704	\$8.47
2	matt black	Zinc	-	-	118.68.804	\$7.06
3	polished nickel	Zinc	170	160	103.30.706	\$8.51
4	polished nickel	Zinc	138	128	103.30.705	\$7.69
5	matt black	Zinc	170	160	103.30.806	\$6.85
6	matt black	Zinc	138	128	103.30.805	\$6.21
7	polished nickel	Zinc	-	-	110.35.391	\$7.16
8	matt black	Zinc	-	-	110.35.393	\$6.14

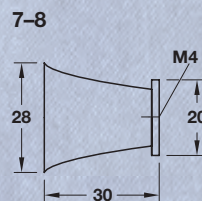
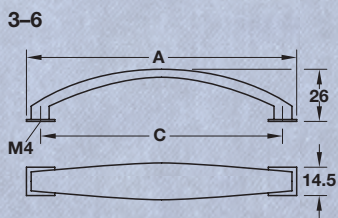
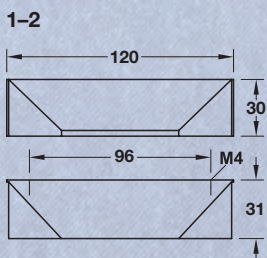



Mid-Century Modern

BY HÄFELE

	Finish	Material	Item No.	SRP/pc.
1	polished chrome	Zinc	110.34.227	\$12.08
2	brushed nickel	Zinc	110.34.627	\$14.17
3	matt black	Zinc	110.34.327	\$12.01
4	matt black	Zinc	110.34.355	\$15.79
5	brushed nickel	Zinc	110.34.655	\$15.27
6	polished chrome	Zinc	110.34.255	\$13.69
7	polished chrome	Zinc	110.35.271	\$3.31
8	matt black	Zinc	110.35.371	\$2.57

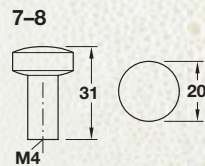
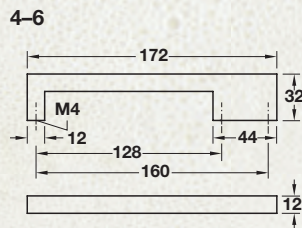
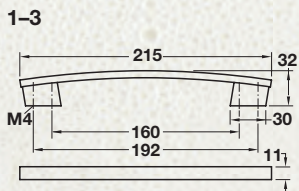



Mid-Century Modern

BY HÄFELE - 4-5

	Finish	Material	A	C	Item No.	SRP/pc.
1	polished chrome	Zinc	-	-	104.33.200	\$19.80
2	matt nickel	Zinc	-	-	104.33.600	\$14.05
3	dark oil-rubbed bronze	Zinc	-	-	104.33.330	\$17.79
4	oil-rubbed bronze	Zinc	148	128	106.61.043	\$11.25
5	oil-rubbed bronze	Zinc	180	160	106.61.044	\$12.38

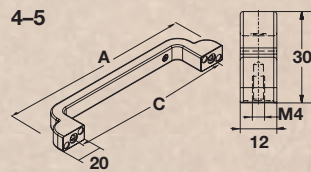
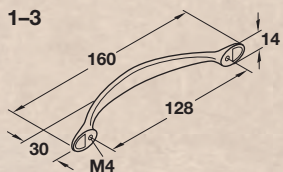



Mid-Century Modern

BY HÄFELE - 5-6

	Finish	Material	A	B	C	D	Item No.	SRP/pc.
1	stainless steel look	Zinc	192	17	128	24	104.80.002	\$21.96
2	matt nickel	Zinc	230	20	160	26	104.80.600	\$18.15
3	matt nickel	Zinc	-	-	-	-	109.57.602	\$33.42
4	matt chrome	Zinc	-	-	-	-	109.80.401	\$17.95
5	matt black	Zinc	-	-	-	-	106.69.501	\$7.58
6	brushed brass	Zinc	-	-	-	-	106.69.502	\$7.95
7	matt nickel	Brass	-	-	-	-	136.76.610	\$11.26
8	satin nickel	Zinc	-	-	-	-	105.49.620	\$18.54
9	brushed nickel	Brass	-	-	-	-	161.16.600	\$39.08
10	matt aluminum	Zinc	-	-	-	-	107.40.902	\$18.84

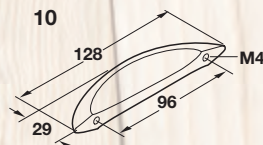
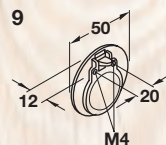
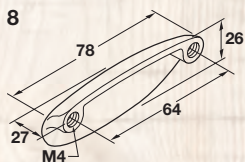
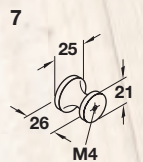
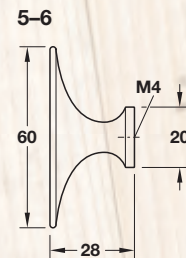
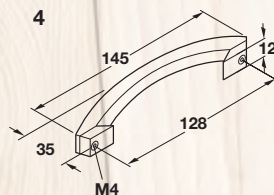
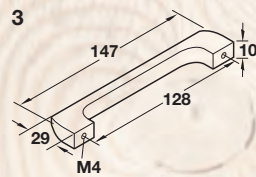
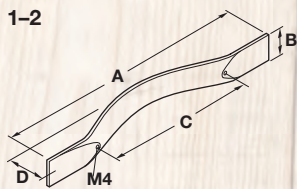

Dimensions in mm unless otherwise noted. Prices subject to change.



Aeon



	Finish	Material	A	C	Item No.	SRP/pc.
1	graphite	Zinc	127	96	110.22.050	\$11.39
2	matt gold	Zinc	127	96	110.22.080	\$20.36
3	graphite	Zinc	191	160	110.22.086	\$18.31
4	matt gold	Zinc	191	160	110.22.081	\$26.90
5	graphite	Zinc	351	320	110.22.089	\$26.52
6	matt gold	Zinc	351	320	110.22.082	\$35.08

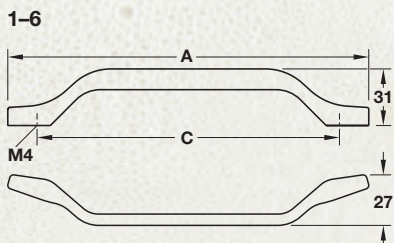



8



7



5



4



6



3



2



1

Mid-Century Modern



	Finish	Material	A	B	C	Item No.	SRP/pc.
1	polished chrome	Zinc	-	-	-	104.66.200	\$17.99
2	matt nickel	Zinc	-	-	-	104.66.600	\$16.26
3	black matt	Zinc	-	-	-	104.66.300	\$17.13
4	matt	Stainless Steel	12	20	7	155.01.510	\$17.62
5	matt	Stainless Steel	16	26	9	155.01.511	\$19.78
6	matt	Stainless Steel	20	28	11	155.01.512	\$21.66
7	brushed nickel	Brass	-	-	-	155.01.571	\$54.88
8	brushed	Brass	-	-	-	155.01.572	\$47.10

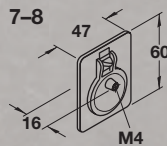
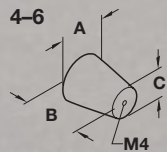
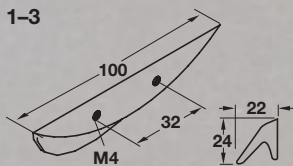



Mid-Century Modern



	Finish
1	matt
2	matt
3	matt nickel
4	matt nickel
5	polished chrome
6	brushed
7	polished chrome
8	matt nickel

	Material
1	Stainless Steel
2	Stainless Steel
3	Zinc
4	Zinc
5	Brass
6	Brass
7	Brass
8	Brass

	Item No.	SRP/pc.
1	134.83.602	\$7.97
2	134.82.605	\$6.96
3	155.00.570	\$2.14
4	105.26.600	\$4.80
5	136.76.205	\$6.98
6	137.21.500	\$5.93
7	136.06.212	\$4.95
8	136.06.614	\$4.59

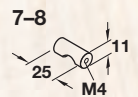
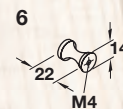
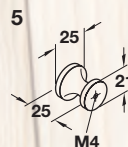
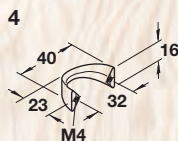
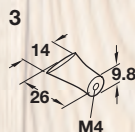
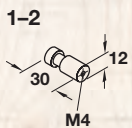



Avignon

	Finish	Material	A	C	Item No.	SRP/pc.
1	satin nickel	Zinc	336	288	108.78.017	\$55.38
2	polished chrome	Zinc	336	288	108.78.217	\$47.66
3	satin nickel	Zinc	203	160	108.78.013	\$37.44
4	polished chrome	Zinc	203	160	108.78.213	\$28.32

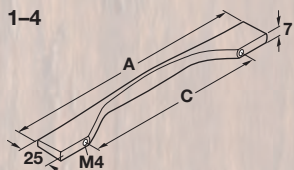

Dimensions in mm unless otherwise noted. Prices subject to change.



Mid-Century Modern

	Finish	Material	A	C	Item No.	SRP/pc.
1	polished chrome	Zinc	130	96	108.76.231	\$27.88
2	polished chrome	Zinc	164	128	108.76.232	\$33.74
3	polished chrome	Zinc	194	160	108.76.233	\$35.40
4	black matt	Zinc	194	160	108.76.240	\$30.22
5	black matt	Zinc	130	96	108.76.245	\$25.66
6	black matt	Zinc	164	128	108.76.250	\$29.44

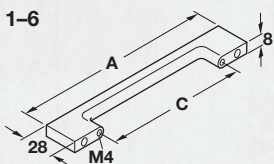



Mid-Century Modern

	Finish	Material	A	C	Item No.	SRP/pc.
1	matt gold	Zinc	194	160	108.76.241	\$33.34
2	matt gold	Zinc	164	128	108.76.251	\$26.84
3	matt gold	Zinc	130	96	108.76.246	\$25.20
4	satin nickel	Zinc	130	96	108.76.731	\$30.96
5	satin nickel	Zinc	194	160	108.76.733	\$38.70
6	satin nickel	Zinc	164	128	108.76.732	\$34.60

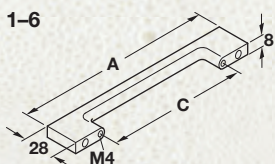



Mid-Century Modern

	Finish
1	stainless steel look
2	matt nickel
3	matt black
4	matt black

	Material
1	Zinc
2	Zinc
3	Zinc
4	Zinc

	Item No.	SRP/pc.
1	102.71.959	\$16.47
2	105.63.600	\$27.76
3	105.63.300	\$17.07
4	102.81.320	\$21.80

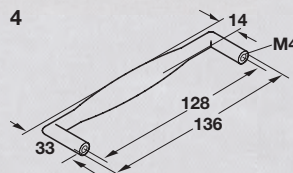
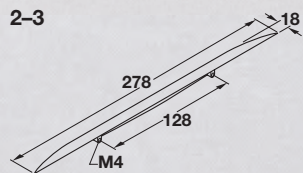
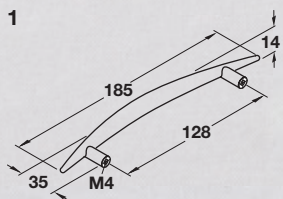



Aventura **NEW**

	Finish	Material	Item No.	SRP/pc.
1	satin nickel	Zinc	102.47.300	\$16.05
2	polished chrome	Zinc	102.47.301	\$17.28
3	matt gold	Zinc	102.47.302	\$17.28
4	matt black	Zinc	102.47.303	\$14.81
5	satin nickel	Zinc	133.57.610	\$12.35
6	polished chrome	Zinc	133.57.611	\$13.58
7	matt gold	Zinc	133.57.612	\$13.58
8	matt black	Zinc	133.57.613	\$12.35

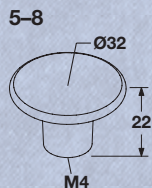
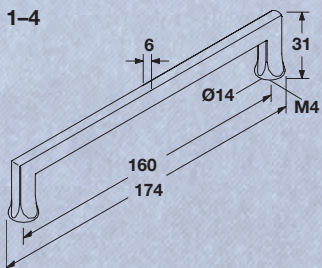

Dimensions in mm unless otherwise noted. Prices subject to change.

MODERN

Clean lines. Hard angles. Modern design conjures the function-focused unity of the Bauhaus and the simple light colors of the Scandinavian schools. Predominantly neutral yet modern design surprises with a pop of color. In deco finishes, modern style features stainless steel, nickel or black finishes.







Modern NEW

BY HÄFELE

	Finish	Material	A	B	C	Item No.	SRP/pc.
1	black brushed nickel	Zinc	180	25	128	106.69.190	\$11.64
2	brushed nickel	Zinc	180	25	128	106.69.170	\$11.46
3	black brushed nickel	Zinc	373	28	320	106.69.191	\$26.64
4	brushed nickel	Zinc	373	28	320	106.69.171	\$26.10
5	brushed nickel	Zinc	212	25	160	106.69.010	\$11.42
6	black brushed nickel	Zinc	212	25	160	106.69.011	\$11.68
7	matt gold	Zinc	right	-	-	101.69.504	\$12.81
8	matt gold	Zinc	left	-	-	101.69.505	\$12.81
9	matt black	Zinc	right	-	-	101.69.510	\$10.38
10	matt black	Zinc	left	-	-	101.69.511	\$10.38

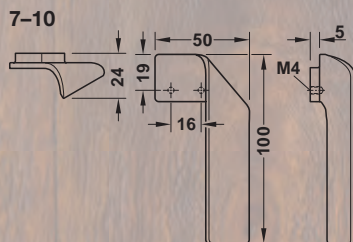
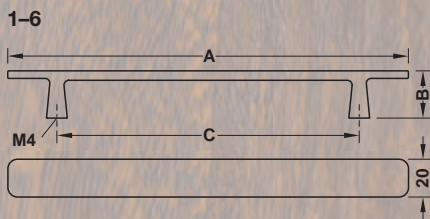



Zurich NEW

BY HÄFELE

	Finish	Material	A	C	Item No.	SRP/pc.
1	polished chrome	Zinc	83	64	155.01.992	\$5.34
2	polished chrome	Zinc	147	128	155.02.002	\$9.98
3	polished chrome	Zinc	184	160	155.02.012	\$11.39
4	matt nickel	Zinc	83	64	155.01.991	\$5.11
5	matt nickel	Zinc	147	128	155.02.001	\$9.57
6	matt nickel	Zinc	184	160	155.02.011	\$10.94
7	brushed brass	Zinc	184	160	155.02.013	\$12.68
8	brushed brass	Zinc	147	128	155.02.003	\$10.92
9	brushed brass	Zinc	83	64	155.01.993	\$6.15

1-6

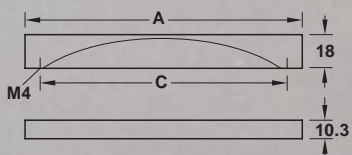



Manhattan NEW

BY HÄFELE

	Finish	Material	A	C	Item No.	SRP/pc.
1	brushed brass	Aluminum	200	128	155.02.351	\$13.99
2	matt black	Aluminum	200	128	155.02.321	\$14.60
3	silver anodized	Aluminum	200	128	155.02.331	\$12.99
4	stainless steel	Aluminum	200	128	155.02.341	\$14.62
5	brushed brass	Aluminum	100	64	155.02.350	\$10.58
6	matt black	Aluminum	100	64	155.02.320	\$10.58
7	silver anodized	Aluminum	100	64	155.02.330	\$9.73
8	stainless steel	Aluminum	100	64	155.02.340	\$10.58

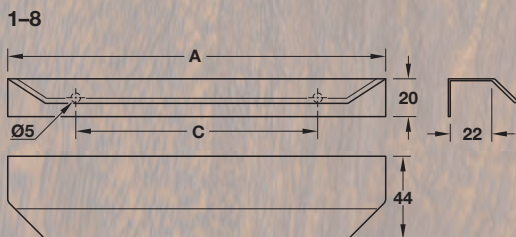



Manhattan NEW

BY HÄFELE

	Finish	Material	A	C	Item No.	SRP/pc.
1	matt black	Aluminum	350	256	155.02.322	\$22.60
2	brushed brass	Aluminum	350	256	155.02.352	\$22.46
3	silver anodized	Aluminum	350	256	155.02.332	\$19.81
4	stainless steel	Aluminum	350	256	155.02.342	\$21.60

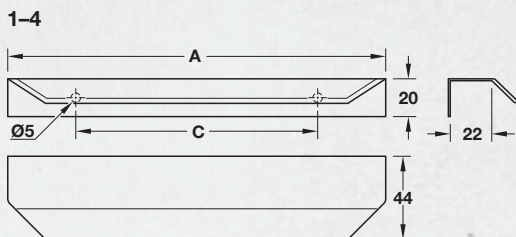

Dimensions in mm unless otherwise noted. Prices subject to change.



Cube

BY HÄFELE

	Finish	Material	A	C	Item No.	SRP/pc.
1	matt black	Aluminum	206	192	106.70.042	\$20.40
2	brushed nickel	Aluminum	206	192	106.70.032	\$24.32
3	matt black	Aluminum	174	160	106.70.041	\$18.30
4	brushed nickel	Aluminum	174	160	106.70.031	\$22.36
5	matt black	Aluminum	–	–	106.70.082	\$8.22
6	brushed nickel	Aluminum	–	–	106.70.081	\$10.19
7	matt black	Aluminum	142	128	106.70.040	\$16.46
8	brushed nickel	Aluminum	142	128	106.70.030	\$19.36
9	matt black	Aluminum	–	–	106.70.072	\$4.74
10	brushed nickel	Aluminum	–	–	106.70.071	\$5.73

1-4, 7-8

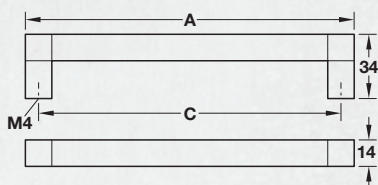

5-6

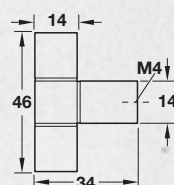

9-10

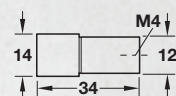



Modern

BY HÄFELE

	Finish	Material	A	C	Item No.	SRP/pc.
1	polished chrome	Zinc	148	128	106.69.205	\$20.86
2	polished chrome	Zinc	212	192	106.69.207	\$27.46
3	brushed nickel	Zinc	148	128	106.69.605	\$18.96
4	brushed nickel	Zinc	212	192	106.69.607	\$29.36
5	black matt	Zinc	202	192	110.34.307	\$10.14
6	black matt	Zinc	170	160	110.34.306	\$9.19
7	brushed nickel	Zinc	170	160	110.34.606	\$13.76
8	brushed nickel	Zinc	202	192	110.34.607	\$15.94

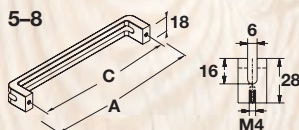
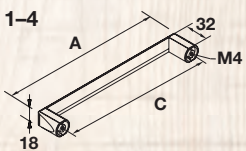



Neoteric



	Finish	Material	A	C	Item No.	SRP/pc.
1	matt black	Aluminum	350	256	155.01.831	\$21.50
2	matt black	Aluminum	300	256	155.01.850	\$18.42
3	matt black	Aluminum	800	640	155.01.835	\$40.78
4	matt black	Aluminum	700	640	155.01.854	\$37.78
5	matt black	Aluminum	500	384	155.01.833	\$29.42
6	matt black	Aluminum	400	352	155.01.852	\$24.04
7	matt black	Aluminum	-	-	155.01.870	\$7.97

1, 3, 5

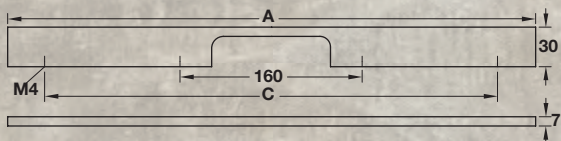

2, 4, 6

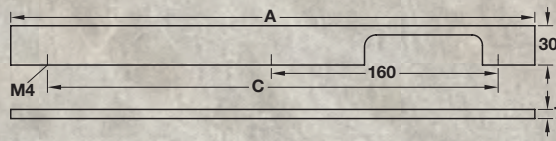

7

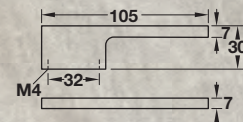



Neoteric



	Finish	Material	A	C	Item No.	SRP/pc.
1	matt black	Aluminum	350	288	155.01.851	\$21.28
2	polished chrome	Aluminum	350	288	155.01.861	\$27.14
3	matt black	Aluminum	400	320	155.01.832	\$24.12
4	polished chrome	Aluminum	500	384	155.01.843	\$37.90
5	matt black	Aluminum	700	560	155.01.834	\$37.64
6	matt black	Aluminum	800	736	155.01.855	\$40.56
7	polished chrome	Aluminum	800	640	155.01.845	\$55.10
8	matt black	Aluminum	500	448	155.01.853	\$29.22
9	polished chrome	Aluminum	300	224	155.01.840	\$23.80
10	matt black	Aluminum	300	224	155.01.830	\$18.63

1-2, 6, 8

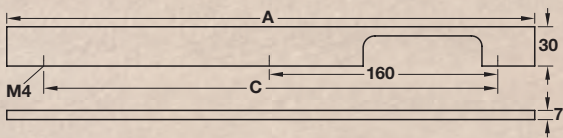

3-5, 7, 9-10

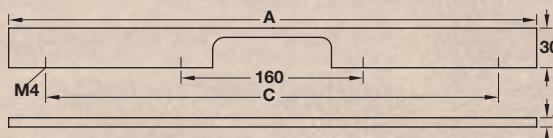



Neoteric



	Finish	Material	A	C	Item No.	SRP/pc.
1	polished chrome	Aluminum	300	256	155.01.860	\$23.56
2	polished chrome	Aluminum	350	256	155.01.841	\$27.34
3	polished chrome	Aluminum	400	352	155.01.862	\$30.82
4	polished chrome	Aluminum	800	736	155.01.865	\$54.92
5	polished chrome	Aluminum	700	560	155.01.844	\$50.98
6	polished chrome	Aluminum	700	640	155.01.864	\$50.92
7	polished chrome	Aluminum	500	448	155.01.863	\$37.82
8	polished chrome	Aluminum	400	320	155.01.842	\$30.86
9	polished chrome	Aluminum	-	-	155.01.871	\$10.11

1, 3-4, 6-7

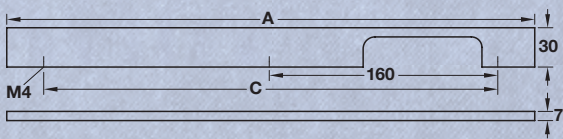

2, 5, 8

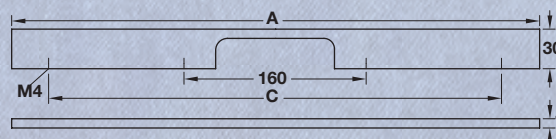

9

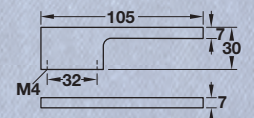



Modern



	Finish	Material	Item No.	SRP/pc.
1	matt nickel	Zinc	105.34.602	\$10.22
2	matt nickel	Zinc	106.09.601	\$18.35
3	satin nickel	Zinc	155.00.350	\$2.84
4	polished chrome	Zinc	106.69.280	\$3.35
5	polished chrome	Zinc	155.02.240	\$4.17
6	brushed nickel	Zinc	155.02.241	\$4.29
7	matt black	Zinc	155.02.243	\$3.84
8	brushed brass	Zinc	155.02.242	\$4.14

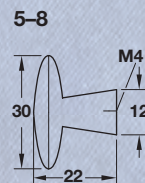
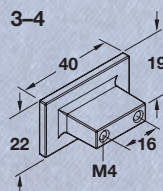
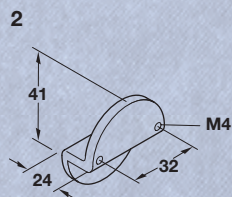
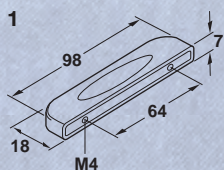

Dimensions in mm unless otherwise noted. Prices subject to change.



Singapore



	Finish	Material	A	C	C1	Item No.	SRP/pc.
1	matt black	Aluminum	200	128	96	155.02.360	\$21.50
2	stainless steel look	Aluminum	200	128	96	110.46.084	\$25.84
3	matt black	Aluminum	400	320	192	155.02.361	\$37.54
4	stainless steel look	Aluminum	400	320	192	110.46.087	\$40.84
5	oil-rubbed bronze	Aluminum	200	128	-	126.45.046	\$18.22
6	stainless steel look	Aluminum	200	128	-	126.14.605	\$16.29
7	silver anodized	Aluminum	200	128	-	126.45.965	\$16.29
8	oil-rubbed bronze	Aluminum	350	256	-	126.45.049	\$28.14
9	stainless steel look	Aluminum	350	256	-	126.14.608	\$24.40
10	silver anodized	Aluminum	350	256	-	126.45.969	\$24.40

1-4

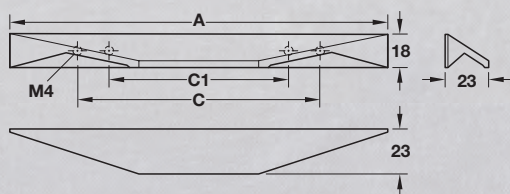

5-10

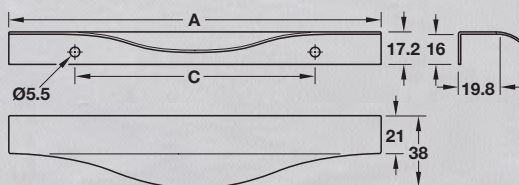



Isabella

	Finish	Material	A	C1	C	Item No.	SRP/pc.
1	matt aluminum	Aluminum	156	96	128	108.94.901	\$48.22
2	matt aluminum	Aluminum	220	128	192	155.00.971	\$52.32
3	matt aluminum	Aluminum	284	160	256	108.94.903	\$55.82
4	matt aluminum	Aluminum	348	192	320	108.94.904	\$58.50
5	matt aluminum	Aluminum	412	224	384	108.94.905	\$63.08
6	matt aluminum	Aluminum	540	288	512	108.94.907	\$65.62
7	matt aluminum	Aluminum	476	256	448	108.94.906	\$65.94

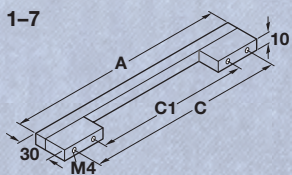

Dimensions in mm unless otherwise noted. Prices subject to change.



Resonance

	Finish	Material	A	C	Item No.	SRP/pc.
1	stainless steel	Aluminum	170	160	112.82.003	\$38.70
2	stainless steel	Aluminum	202	192	112.82.004	\$39.44
3	stainless steel	Aluminum	300	290	112.82.007	\$62.92
4	stainless steel	Aluminum	400	390	112.82.010	\$65.52
5	matt aluminum	Aluminum	170	160	112.82.903	\$35.02
6	matt aluminum	Aluminum	400	390	112.82.910	\$54.30
7	matt aluminum	Aluminum	300	290	112.82.907	\$44.78
8	matt aluminum	Aluminum	202	192	112.82.904	\$43.80

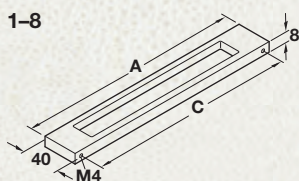

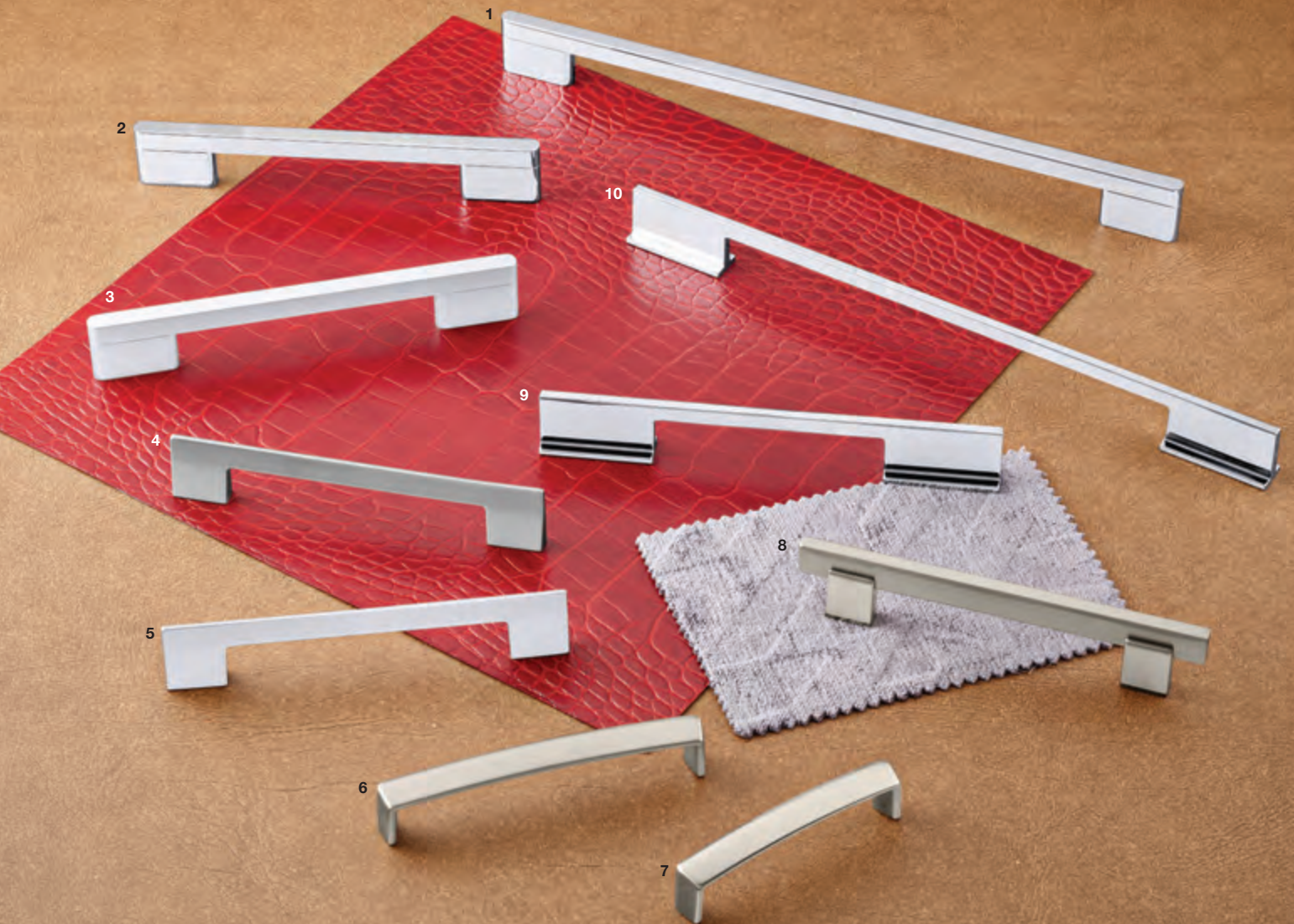

Modern

	Finish	Material	A	C1	C	Item No.	SRP/pc.
1	polished chrome	Aluminum	360	-	320	108.94.228	\$74.06
2	polished chrome	Aluminum	200	-	160	108.94.223	\$57.62
3	matt aluminum	Aluminum	200	-	160	108.94.923	\$35.66
4	stainless steel look	Zinc	-	-	-	111.93.686	\$14.69
5	polished chrome	Zinc	-	-	-	111.93.286	\$14.59
6	satin nickel	Zinc	136	-	128	111.59.625	\$26.38
7	satin nickel	Zinc	104	-	96	111.59.624	\$23.50
8	satin nickel	Zinc	-	-	-	111.24.605	\$36.90
9	polished chrome	Aluminum	206	160	192	112.81.273	\$43.32
10	polished chrome	Aluminum	334	288	320	112.81.278	\$79.06

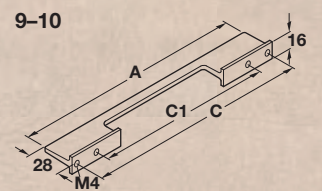
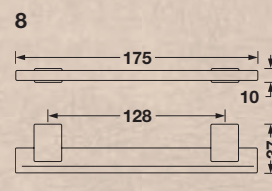
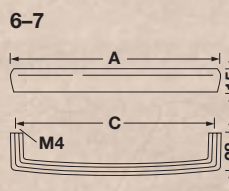
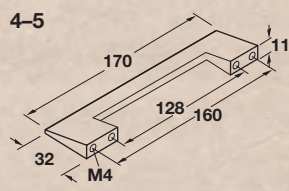
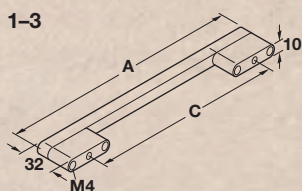

Dimensions in mm unless otherwise noted. Prices subject to change.



Affinity NEW

	Finish	Material	A	C	Item No.	SRP/pc.
1	polished chrome	Zinc	264	256	102.47.361	\$46.92
2	polished chrome	Zinc	200	192	102.47.351	\$27.19
3	matt gold	Zinc	264	256	102.47.362	\$46.92
4	matt gold	Zinc	200	192	102.47.352	\$27.19
5	satin nickel	Zinc	200	192	102.47.350	\$27.19
6	satin nickel	Zinc	264	256	102.47.360	\$46.92
7	matt black	Zinc	200	192	102.47.353	\$27.19
8	matt black	Zinc	264	256	102.47.363	\$46.92

Note
Refer to page 260 for matching appliance pulls.

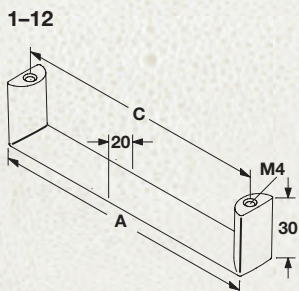



Affinity NEW

	Finish	Material	A	B	C	D	Item No.	SRP/pc.
1	satin nickel	Zinc	72	28	64	17	102.47.320	\$17.28
2	satin nickel	Zinc	137	30	128	20	102.47.330	\$23.45
3	satin nickel	Zinc	168	30	160	20	102.47.340	\$24.72
4	matt gold	Zinc	168	30	160	20	102.47.342	\$24.72
5	matt gold	Zinc	137	30	128	20	102.47.332	\$23.45
6	matt gold	Zinc	72	28	64	17	102.47.322	\$17.28
7	matt black	Zinc	72	28	64	17	102.47.323	\$17.28
8	matt black	Zinc	137	30	128	20	102.47.333	\$23.45
9	matt black	Zinc	168	30	160	20	102.47.343	\$24.72
10	polished chrome	Zinc	72	28	64	17	102.47.321	\$17.28
11	polished chrome	Zinc	137	30	128	20	102.47.331	\$23.45
12	polished chrome	Zinc	168	30	160	20	102.47.341	\$24.72

Note

Refer to page 260 for matching appliance pulls.

1-12

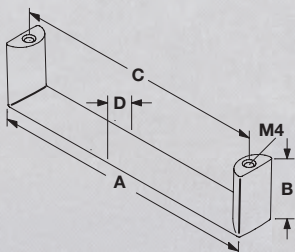

Dimensions in mm unless otherwise noted. Prices subject to change.



Modern *NEW

	Finish	Material	A	C	Item No.	SRP/pc.
1*	matt black	Zinc	-	-	102.47.393	\$19.75
2*	matt gold	Zinc	-	-	102.47.392	\$20.99
3*	satin nickel	Zinc	-	-	102.47.390	\$19.75
4*	polished chrome	Zinc	-	-	102.47.391	\$19.75
5	satin nickel, antimicrobial	Zinc	138	128	116.07.700	\$22.18
6	satin nickel, antimicrobial	Zinc	202	192	116.07.701	\$25.68

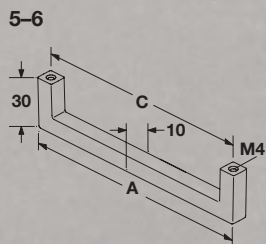
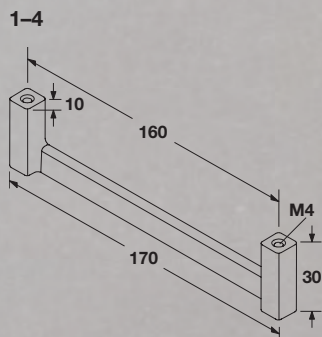



Essential'z

BY AMEROCK

ADA 2-3

	Finish	Material	A	B	C	Item No.	SRP/pc.
1	matt	Stainless Steel	-	-	-	133.50.681	\$26.62
2	matt nickel	Zinc	106	30	96	133.50.276	\$17.42
3	matt nickel	Zinc	170	29	160	133.50.275	\$18.99

Note
Supplied with 1" mounting screws.

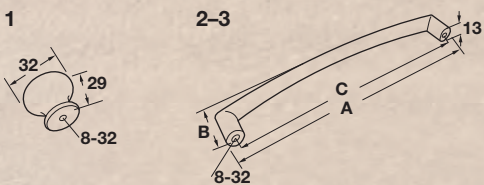

Dimensions in mm unless otherwise noted. Prices subject to change.



Cyprus

BY AMEROCK

	Finish	Material	A	B	C	D	Item No.	SRP/pc.
1	black bronzed	Zinc	167	29	96	13	133.53.109	\$14.23
2	black bronzed	Zinc	133	27	76 (3")	10	133.53.108	\$9.50
3	polished nickel	Zinc	133	27	76 (3")	10	133.53.118	\$9.50
4	polished nickel	Zinc	167	29	96	13	133.53.119	\$14.23
5	black bronzed	Zinc	230	32	160	13	133.53.110	\$22.89
6	polished nickel	Zinc	230	32	160	13	133.53.120	\$22.89
7	black bronzed	Zinc	198	30	128	13	133.53.112	\$17.42
8	polished nickel	Zinc	198	30	128	13	133.53.122	\$17.42

Note

Supplied with 1" mounting screws. Refer to page 262 for matching appliance pulls.

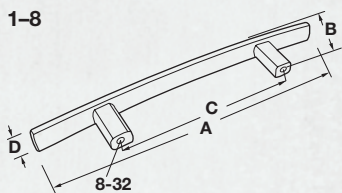



Cyprus

BY AMEROCK

	Finish	Material	A	B	C	D	Item No.	SRP/pc.
1	gold champagne	Zinc	133	27	76 (3")	10	133.53.113	\$9.50
2	gold champagne	Zinc	167	29	96	13	133.53.114	\$14.23
3	gold champagne	Zinc	230	32	160	13	133.53.115	\$22.89
4	gold champagne	Zinc	198	30	128	13	133.53.117	\$17.42
5	satin nickel	Zinc	230	32	160	13	133.50.263	\$20.61
6	satin nickel	Zinc	198	30	128	13	133.50.262	\$17.42
7	satin nickel	Zinc	167	29	96	13	133.50.265	\$14.23
8	satin nickel	Zinc	133	27	76 (3")	10	133.50.264	\$9.50

Note

Supplied with 1" mounting screws. Refer to page 262 for matching appliance pulls.

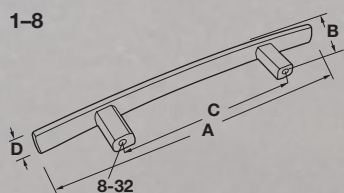

Dimensions in mm unless otherwise noted. Prices subject to change.



Oberon

BY AMEROCK

	Finish	Material	A	B	Item No.	SRP/pc.
1	gold champagne	Zinc	35	30	133.50.618	\$15.84
2	gold champagne	Zinc	44	33	133.50.619	\$18.99
3	gunmetal	Zinc	35	30	133.50.620	\$17.59
4	gunmetal	Zinc	44	33	133.50.621	\$21.11
5	polished nickel	Zinc	44	33	133.50.623	\$18.99
6	polished nickel	Zinc	35	30	133.50.622	\$15.84
7	satin nickel	Zinc	44	33	133.50.625	\$18.99
8	satin nickel	Zinc	35	30	133.50.624	\$15.84

Note
Supplied with 1" mounting screws.

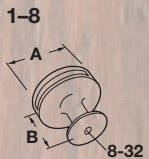



Oberon

BY AMEROCK

	Finish	Material	A	B	Item No.	SRP/pc.
1	polished nickel/frosted	Zinc/Acrylic	44	33	133.50.105	\$24.67
2	gold champagne/frosted	Zinc/Acrylic	44	33	133.50.101	\$22.19
3	satin nickel/frosted	Zinc/Acrylic	44	33	133.50.107	\$21.04
4	gunmetal/frosted	Zinc/Acrylic	44	33	133.50.103	\$24.67
5	gunmetal/frosted	Zinc/Acrylic	35	30	133.50.102	\$19.37
6	gold champagne/frosted	Zinc/Acrylic	35	30	133.50.100	\$17.42
7	polished nickel/frosted	Zinc/Acrylic	35	30	133.50.104	\$19.37
8	satin nickel/frosted	Zinc/Acrylic	35	30	133.50.106	\$16.59

Note
Supplied with 1" mounting screws.

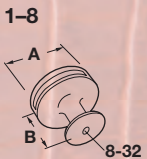

URBAN/INDUSTRIAL

Raw. Real. Rebar. Industrial design takes the wabi-sabi approach; it's the rough edges that make things interesting. Industrial brings us smoldering greys and blacks, glass, concrete, bent steel, chapped brick and high ceilings. Metal is a mainstay. Deco adds to the true grit with a welded edge, a "used" look or knurly textures.







Urban **NEW**

BY HÄFELE

	Finish	Material	A	C	Item No.	SRP/pc.
1	bronze	Aluminum	181	160	106.70.212	\$9.59
2	dark pewter	Aluminum	181	160	106.70.090	\$9.59
3	matt gray	Aluminum	181	160	106.70.091	\$9.59
4	bronze	Aluminum	214	192	106.70.202	\$9.84
5	dark pewter	Aluminum	214	192	106.70.200	\$9.84
6	matt gray	Aluminum	214	192	106.70.201	\$9.84
7	graphite	Zinc	-	-	106.70.185	\$5.29
8	bronze	Zinc	-	-	106.70.186	\$5.29

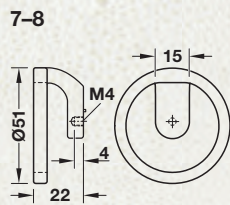
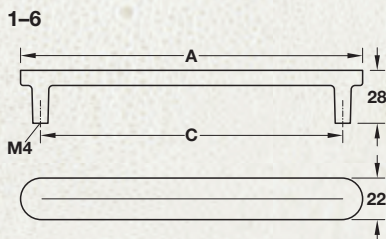



Urban **NEW**

BY HÄFELE

	Finish	Material	A	B	C	Item No.	SRP/pc.
1	polished chrome	Zinc	143	32	128	106.69.162	\$10.67
2	brushed nickel	Zinc	143	32	128	106.69.110	\$11.36
3	polished chrome	Zinc	174	32	160	106.69.022	\$12.15
4	brushed nickel	Zinc	174	32	160	106.69.020	\$12.66
5	polished chrome	Zinc	334	35	320	106.69.163	\$23.30
6	brushed nickel	Zinc	334	35	320	106.69.111	\$25.38

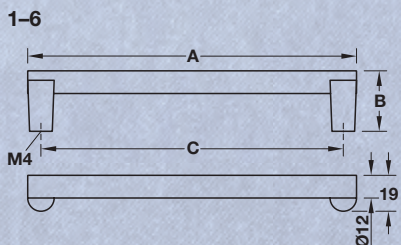

Dimensions in mm unless otherwise noted. Prices subject to change.



Urban **NEW**

BY HÄFELE

	Finish	Material	A	C	Item No.	SRP/pc.
1	brushed nickel	Zinc	108	96	106.69.120	\$5.57
2	polished chrome	Zinc	108	96	106.69.140	\$5.49
3	brushed nickel	Zinc	140	128	106.69.121	\$6.88
4	polished chrome	Zinc	140	128	106.69.141	\$6.71
5	brushed nickel	Zinc	171	160	106.69.030	\$8.03
6	polished chrome	Zinc	171	160	106.69.032	\$7.83
7	brushed nickel	Zinc	-	-	106.69.150	\$2.65
8	polished chrome	Zinc	-	-	106.69.152	\$2.56

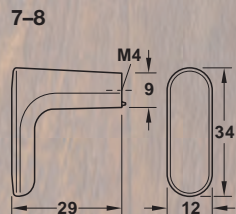
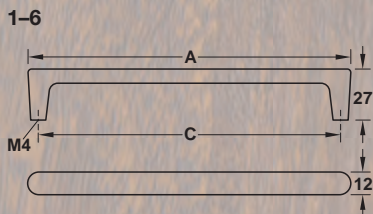



Textile/Bent

BY HÄFELE

- | | Finish |
|---|------------------------|
| 1 | matt black |
| 2 | champagne colored matt |
| 3 | polished brass |
| 4 | brushed nickel |
| 5 | matt black |

- | | Material | Item No. | SRP/pc. |
|---|-----------------|-----------------|----------------|
| 1 | Zinc | 106.70.003 | \$13.63 |
| 2 | Zinc | 106.70.000 | \$13.63 |
| 3 | Zinc | 106.70.005 | \$18.91 |
| 4 | Zinc | 106.70.013 | \$15.17 |
| 5 | Zinc | 106.70.011 | \$12.69 |

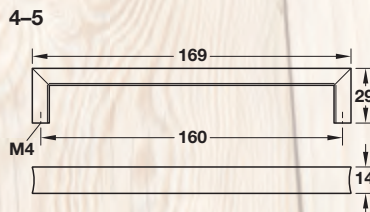
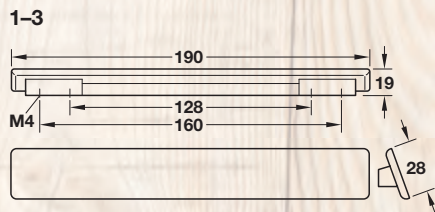

Dimensions in mm unless otherwise noted. Prices subject to change.



Urban

BY HÄFELE - 4-7

	Finish	Material	Item No.	SRP/pc.
1	matt nickel	Zinc	101.80.603	\$16.15
2	brushed nickel	Brass	106.34.643	\$43.82
3	matt nickel	Zinc	116.22.610	\$5.35
4	polished chrome	Zinc	110.34.271	\$9.31
5	polished chrome	Zinc	110.34.274	\$15.84
6	brushed nickel	Zinc	110.34.674	\$15.84
7	brushed nickel	Zinc	110.34.671	\$9.31
8	stainless steel	Zinc	152.16.001	\$108.22

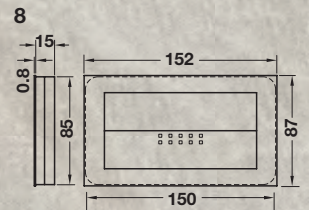
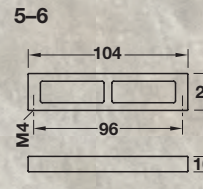
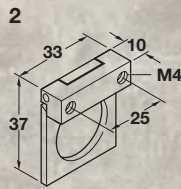
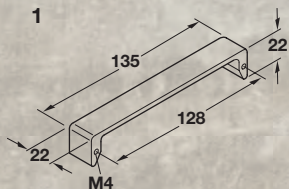

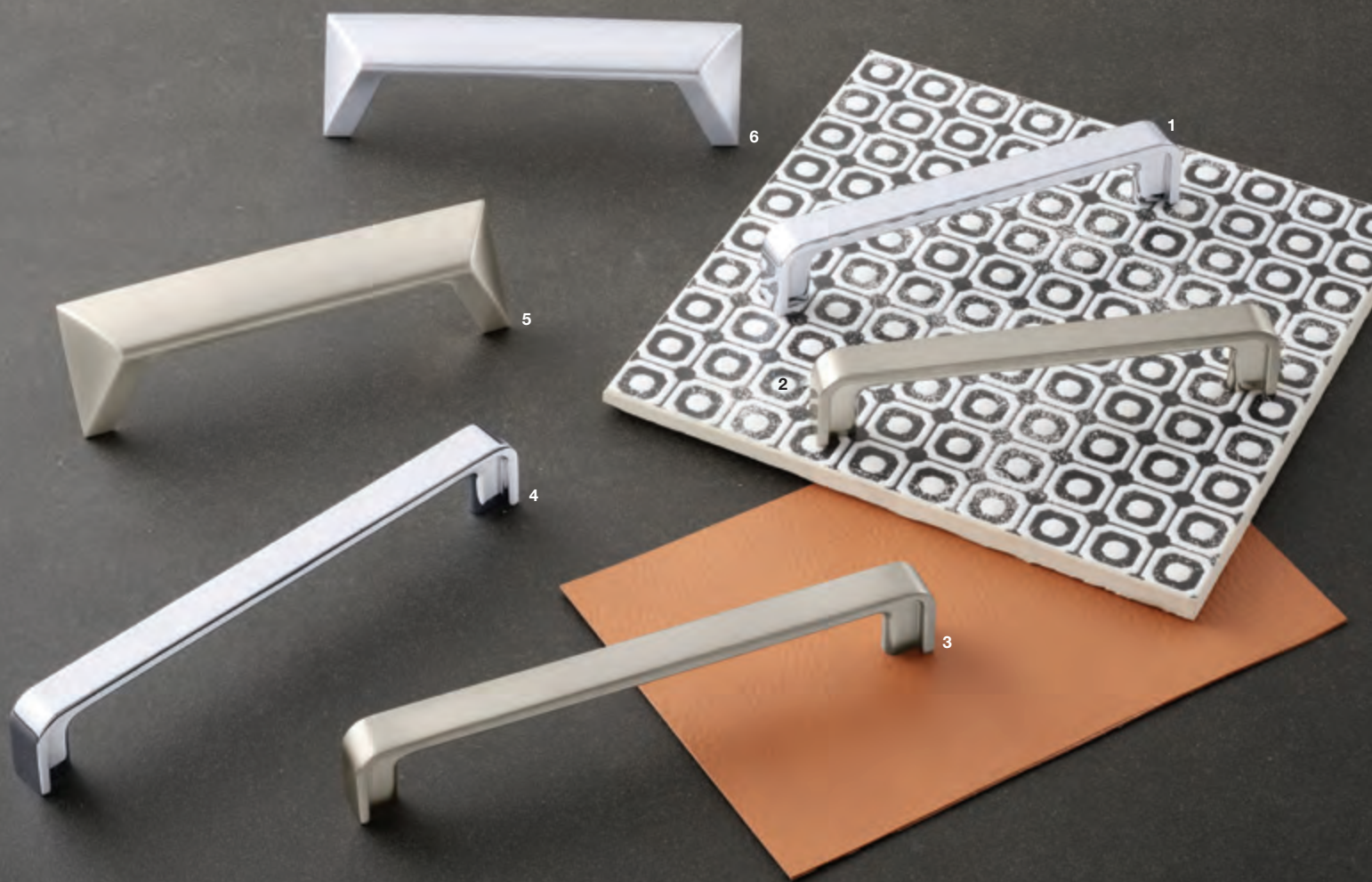

Urban

BY HÄFELE - 1-4

	Finish	Material	A	C	Item No.	SRP/pc.
1	polished chrome	Zinc	146	128	110.34.265	\$10.92
2	brushed nickel	Zinc	146	128	110.34.665	\$9.60
3	brushed nickel	Zinc	178	160	110.34.666	\$11.53
4	polished chrome	Zinc	178	160	110.34.266	\$9.61
5	matt nickel	Zinc	-	-	151.54.600	\$16.44
6	matt chrome	Zinc	-	-	151.54.400	\$16.44

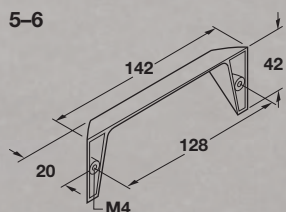
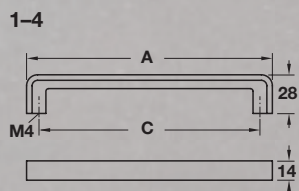



Urban

- | | Finish |
|---|--------------------|
| 1 | highlighted bronze |
| 2 | stainless steel |
| 3 | matt black |
| 4 | matt black |

- | | Material |
|---|-----------------|
| 1 | Brass |
| 2 | Zinc |
| 3 | Zinc |
| 4 | Brass |

- | | Item No. | SRP/pc. |
|---|-----------------|----------------|
| 1 | 108.57.111 | \$60.74 |
| 2 | 111.59.002 | \$29.02 |
| 3 | 116.22.316 | \$4.84 |
| 4 | 151.04.319 | \$98.32 |

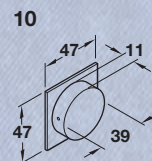
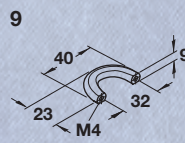
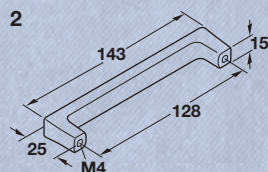
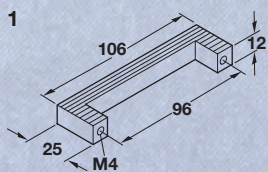



Urban

	Finish	Material	Item No.	SRP/pc.
1	silver matt	Zinc	106.65.650	\$11.87
2	matt black	Zinc	106.65.350	\$8.90
3	silver matt	Zinc	106.65.646	\$22.36
4	matt black	Zinc	106.65.346	\$17.86
5	polished black	Zinc	105.43.300	\$9.42
6	stainless steel look	Zinc	105.43.400	\$19.14

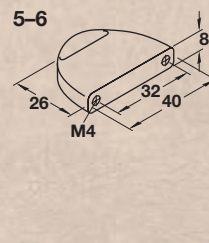
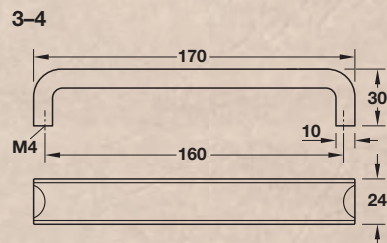
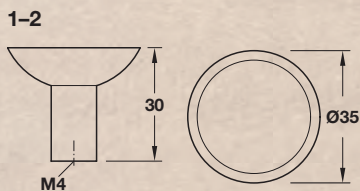

Dimensions in mm unless otherwise noted. Prices subject to change.



District



	Finish	Material	A	C	Item No.	SRP/pc.
1	oil-rubbed bronze	Zinc	-	-	155.01.782	\$5.48
2	polished chrome	Zinc	-	-	155.01.784	\$5.28
3	oil-rubbed bronze	Zinc	143	128	155.01.902	\$18.71
4	polished chrome	Zinc	143	128	155.01.904	\$17.85
5	oil-rubbed bronze	Zinc	207	192	155.01.922	\$26.64
6	polished chrome	Zinc	207	192	155.01.924	\$25.18
7	oil-rubbed bronze	Zinc	175	160	155.01.912	\$22.10
8	polished chrome	Zinc	175	160	155.01.914	\$21.10

1-2

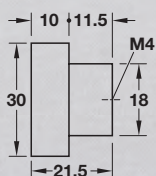

3-8

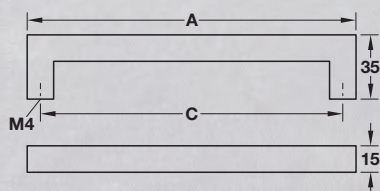



District



	Finish	Material	A	C	Item No.	SRP/pc.
1	brushed brass	Zinc	143	128	155.01.905	\$18.61
2	brushed brass	Zinc	175	160	155.01.915	\$21.98
3	brushed brass	Zinc	207	192	155.01.925	\$26.28
4	brushed brass	Zinc	-	-	155.01.785	\$5.57
5	antique silver	Zinc	143	128	155.01.903	\$18.61
6	antique silver	Zinc	175	160	155.01.913	\$21.98
7	antique silver	Zinc	207	192	155.01.923	\$26.44
8	antique silver	Zinc	-	-	155.01.783	\$5.38

1-3, 5-7

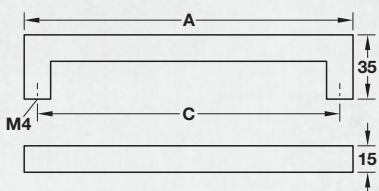

4, 8

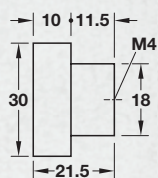



Urban



	Finish	Material	A	C	Item No.	SRP/pc.
1	brushed brass	Aluminum	-	-	132.19.210	\$8.81
2	matt black	Aluminum	-	-	132.19.211	\$5.27
3	polished chrome	Aluminum	-	-	132.15.230	\$5.30
4	stainless steel look	Aluminum	-	-	132.15.630	\$5.31
5	iron colored	Zinc	247	224	116.60.201	\$17.51
6	iron colored	Zinc	183	160	116.60.200	\$13.53

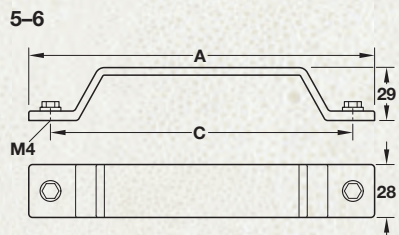
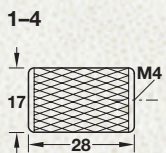



Essex* and Urban



	Finish	Material	A	C	Item No.	SRP/pc.
1	stainless steel look	Zinc	-	-	124.40.053	\$25.32
*2	polished chrome	Zinc	163	128	155.01.880	\$18.81
*3	brushed nickel	Zinc	163	128	155.01.890	\$14.16
*4	polished chrome	Zinc	227	192	155.01.881	\$22.24
*5	brushed nickel	Zinc	227	192	155.01.891	\$16.25
6	stainless steel	Zinc	-	-	113.97.046	\$19.07
7	polished chrome	Zinc	-	-	113.97.246	\$18.30
8	stainless steel	Zinc	-	-	113.97.071	\$13.78
9	polished chrome	Zinc	-	-	113.97.272	\$12.46

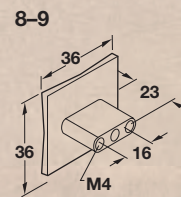
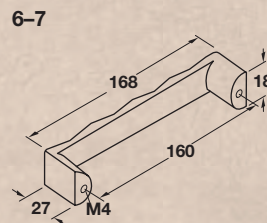
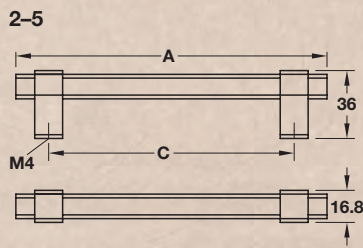
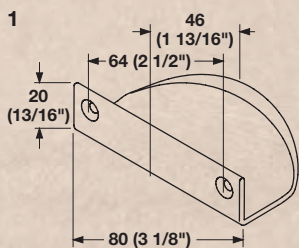

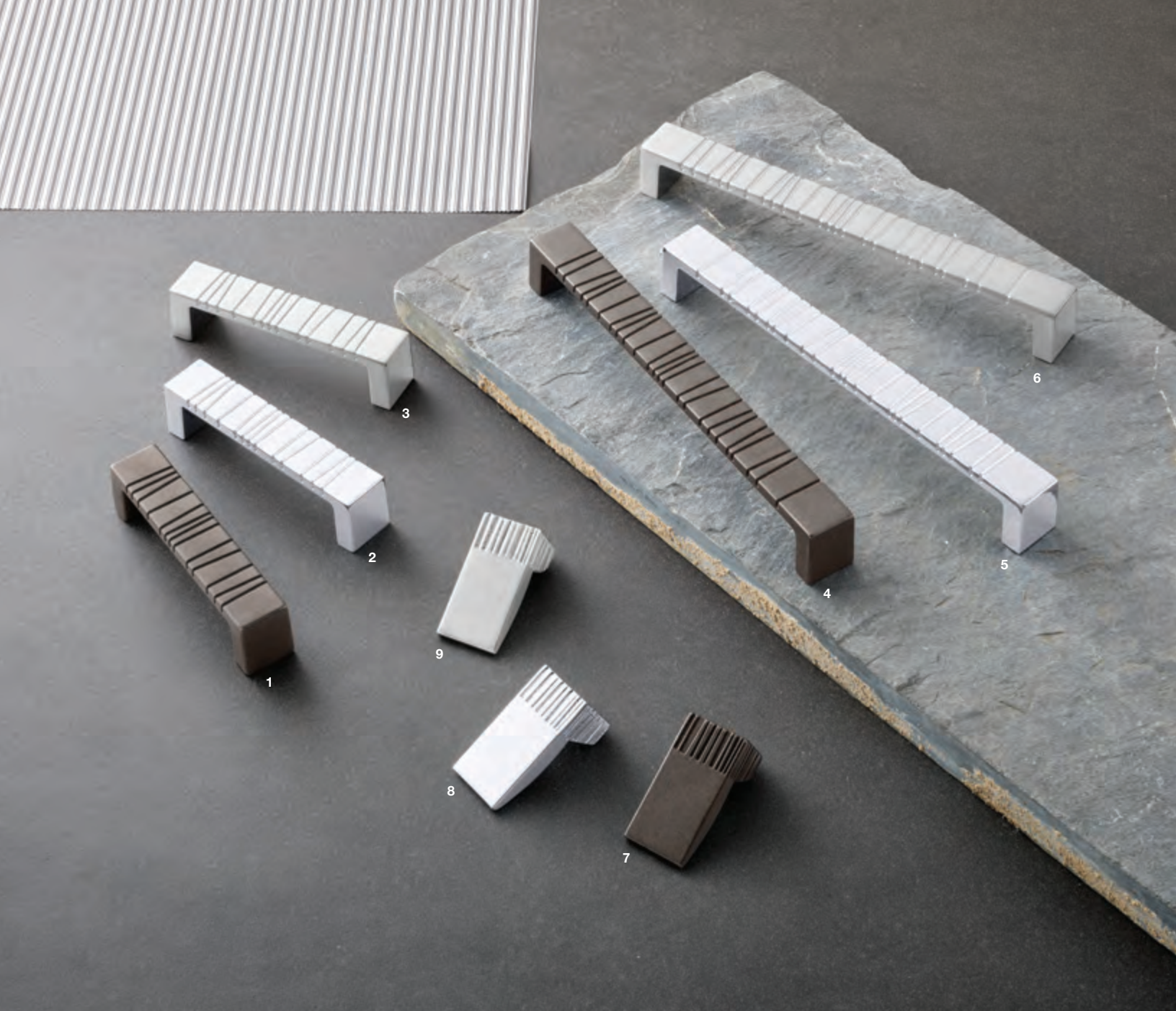

Calypso

	Finish	Material	A	C	Item No.	SRP/pc.
1	oil-rubbed bronze	Zinc	107	96	113.97.424	\$16.49
2	polished chrome	Zinc	107	96	113.97.224	\$17.81
3	stainless steel	Zinc	107	96	113.97.024	\$18.37
4	oil-rubbed bronze	Zinc	203	192	113.97.427	\$21.92
5	polished chrome	Zinc	203	192	113.97.227	\$23.44
6	stainless steel	Zinc	203	192	113.97.027	\$23.98
7	oil-rubbed bronze	Zinc	–	–	113.97.410	\$18.93
8	polished chrome	Zinc	–	–	113.97.210	\$19.95
9	stainless steel	Zinc	–	–	113.97.010	\$19.26

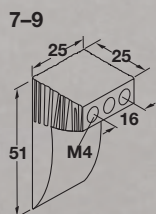
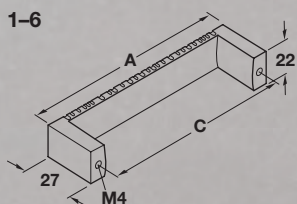

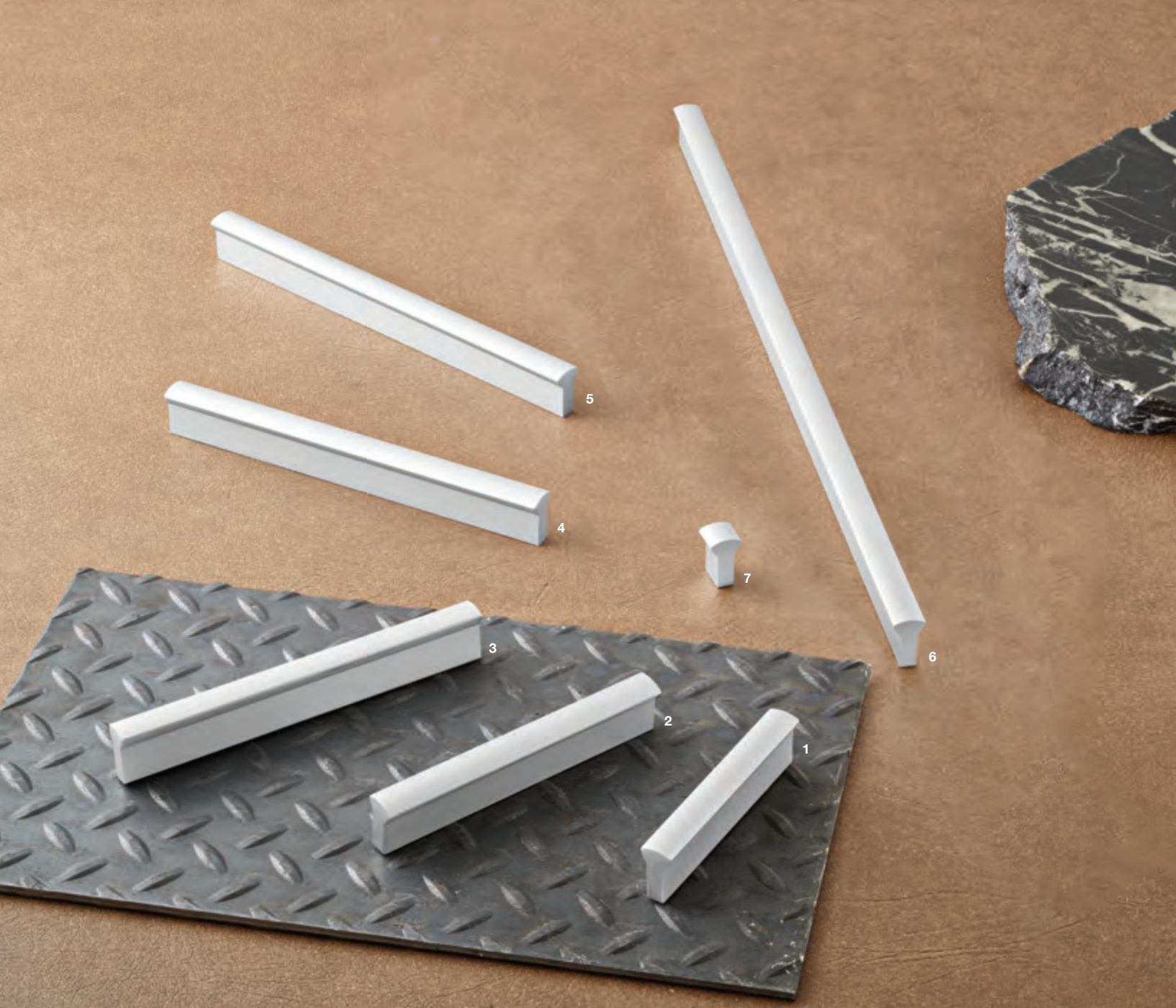

Metropolitan

	Finish	Material	A	C	Item No.	SRP/pc.
1	matt	Aluminum	104	64	103.89.901	\$20.84
2	matt	Aluminum	136	96	103.89.902	\$25.16
3	matt	Aluminum	168	128	103.89.903	\$28.02
4	matt	Aluminum	200	160	103.89.904	\$30.88
5	matt	Aluminum	232	192	103.89.905	\$33.06
6	matt	Aluminum	488	448	103.89.913	\$68.20
7	matt	Aluminum	-	-	135.08.900	\$10.56

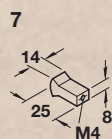
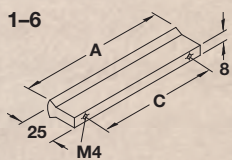



Roxbury NEW

	Finish	Material	A	C	Item No.	SRP/pc.
1	matt gold	Aluminum/Zinc	80	64	106.04.020	\$17.28
2	matt gold	Aluminum/Zinc	272	256	106.04.050	\$32.14
3	dark bronze	Aluminum/Zinc	272	256	106.04.052	\$32.14
4	dark bronze	Aluminum/Zinc	80	64	106.04.022	\$17.28
5	matt black	Aluminum/Zinc	272	256	106.04.051	\$32.14
6	matt black	Aluminum/Zinc	80	64	106.04.021	\$17.28

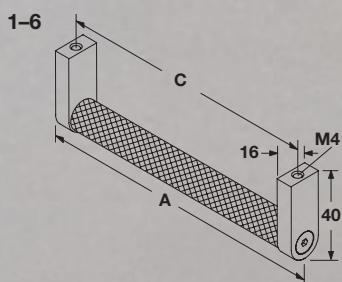



Roxbury NEW

	Finish	Material	A	C	Item No.	SRP/pc.
1	matt gold	Aluminum/Zinc	144	128	106.04.030	\$22.22
2	matt gold	Aluminum/Zinc	176	160	106.04.040	\$27.19
3	dark bronze	Aluminum/Zinc	176	160	106.04.042	\$27.19
4	dark bronze	Aluminum/Zinc	144	128	106.04.032	\$22.22
5	matt black	Aluminum/Zinc	176	160	106.04.041	\$27.19
6	matt black	Aluminum/Zinc	144	128	106.04.031	\$22.22

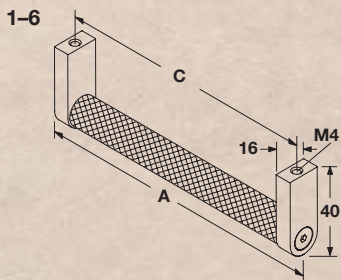

Dimensions in mm unless otherwise noted. Prices subject to change.



Esquire

BY AMEROCK

	Finish	Material	A	C	Item No.	SRP/pc.
1	polished nickel/stainless steel	Zinc/Stainless Steel	119	76 (3")/96	133.50.696	\$23.06
2	polished nickel/stainless steel	Zinc/Stainless Steel	343	320	133.50.695	\$47.93
3	polished nickel/black bronzed	Zinc/Stainless Steel	343	320	133.50.685	\$47.93
4	polished nickel/black bronzed	Zinc/Stainless Steel	279	256	133.50.684	\$39.10
5	polished nickel/black bronzed	Zinc/Stainless Steel	119	76 (3")/96	133.50.686	\$23.06
6	polished nickel/black bronzed	Zinc/Stainless Steel	151	128	133.50.682	\$24.86
7	polished nickel/black bronzed	Zinc/Stainless Steel	183	160	133.50.683	\$26.62
8	polished nickel/black bronzed	Zinc/Stainless Steel	-	-	133.50.707	\$21.28

Note
Supplied with 1" mounting screws.

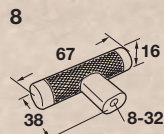
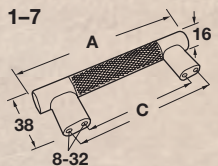



Esquire

BY AMEROCK

	Finish	Material	A	C	Item No.	SRP/pc.
1	polished nickel/stainless steel	Zinc/Stainless Steel	-	-	133.50.709	\$21.28
2	polished nickel/gunmetal	Zinc/Stainless Steel	-	-	133.50.708	\$21.28
3	polished nickel/gunmetal	Zinc/Stainless Steel	119	76 (3")/96	133.50.691	\$23.06
4	polished nickel/gunmetal	Zinc/Stainless Steel	151	128	133.50.687	\$24.86
5	polished nickel/gunmetal	Zinc/Stainless Steel	183	160	133.50.688	\$26.62
6	polished nickel/gunmetal	Zinc/Stainless Steel	279	256	133.50.689	\$39.10
7	polished nickel/gunmetal	Zinc/Stainless Steel	343	320	133.50.690	\$47.63
8	polished nickel/stainless steel	Zinc/Stainless Steel	279	256	133.50.694	\$39.10

Note
Supplied with 1" mounting screws.

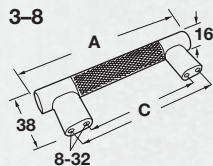
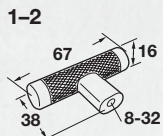



Esquire

BY AMEROCK

	Finish	Material	A	C	Item No.	SRP/pc.
1	satin nickel/oil-rubbed bronze	Zinc/Stainless Steel	-	-	133.50.710	\$21.28
2	polished nickel/stainless steel	Zinc/Stainless Steel	151	128	133.50.692	\$24.86
3	polished nickel/stainless steel	Zinc/Stainless Steel	183	160	133.50.693	\$26.62
4	satin nickel/oil-rubbed bronze	Zinc/Stainless Steel	343	320	133.50.701	\$47.93
5	satin nickel/oil-rubbed bronze	Zinc/Stainless Steel	279	256	133.50.700	\$39.10
6	satin nickel/oil-rubbed bronze	Zinc/Stainless Steel	119	76 (3")/96	133.50.702	\$23.06
7	satin nickel/oil-rubbed bronze	Zinc/Stainless Steel	151	128	133.50.697	\$24.86
8	satin nickel/oil-rubbed bronze	Zinc/Stainless Steel	183	160	133.50.698	\$26.62

Note
Supplied with 1" mounting screws.

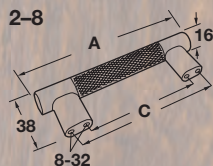
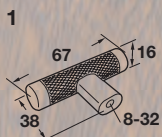



Rochdale/ Kontur

BY AMEROCK

ADA 3-5

	Finish	Material	A	B	C	Item No.	SRP/pc.
1	satin nickel	Zinc	-	-	-	133.50.142	\$12.32
2	satin nickel	Zinc	-	-	-	133.50.632	\$7.29
3	satin nickel	Zinc	121	30	96	133.50.372	\$9.50
4	satin nickel	Zinc	154	32	128	133.50.370	\$11.08
5	satin nickel	Zinc	186	33	160	133.50.371	\$12.66
6	stainless steel	Zinc	-	-	-	133.50.705	\$12.42

Note
Supplied with 1" mounting screws.

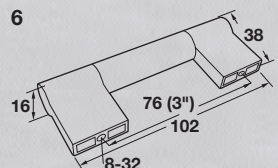
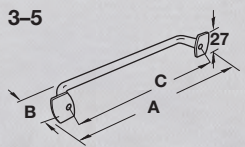
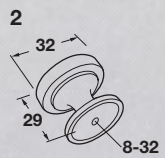
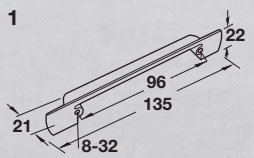

Dimensions in mm unless otherwise noted.

ART DECO/GLAM

Old Hollywood panache with notes of bling. Glam style spotlights bright golds and rich velvets in regal jewel tones that contrast with lavish light catchers. Deco pulls are paved with pavé crystals, knobs add a mod accent with glossy chrome while handles radiate the lush warmth of polished gold.





Art Deco/ Glam

BY HÄFELE

NEW

	Finish	Material	A	B	C	D	Item No.	SRP/pc.
1	matt black/marble	Zinc	-	-	-	-	106.70.180	\$6.49
2	matt black/marble	Zinc	-	-	-	-	106.70.175	\$12.79
3*	brushed nickel	Zinc	130	32	96	15	106.70.150	\$8.77
4*	brushed nickel	Zinc	161	32	128	18	106.70.151	\$10.77
5*	brushed nickel	Zinc	236	35	192	20	106.70.152	\$14.91
6*	brushed nickel	Zinc	-	-	-	-	106.70.171	\$6.74

Note

*Refer to page 255 for matching appliance pulls.

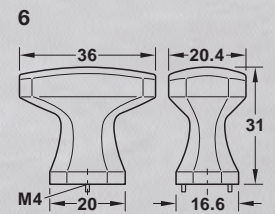
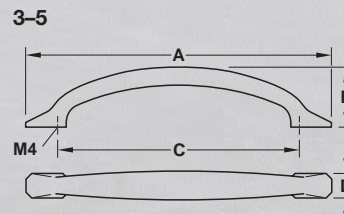
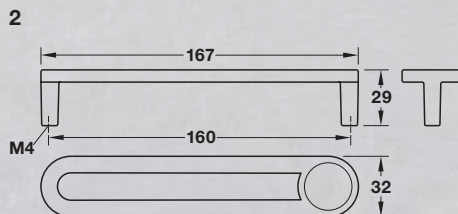
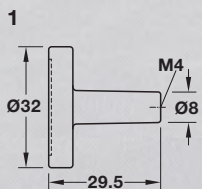



Art Deco/ Glam

BY HÄFELE

NEW

	Finish	Material	A	B	C	D	Item No.	SRP/pc.
1	matt gold	Zinc	130	32	96	15	106.70.160	\$10.35
2	matt gold	Zinc	161	32	128	18	106.70.161	\$11.81
3	matt gold	Zinc	236	35	192	20	106.70.162	\$17.82
4	oil-rubbed bronze	Zinc	130	32	96	15	106.70.220	\$9.44
5	oil-rubbed bronze	Zinc	161	32	128	18	106.70.221	\$11.58
6	oil-rubbed bronze	Zinc	236	35	192	20	106.70.222	\$16.00
7	oil-rubbed bronze	Zinc	-	-	-	-	106.70.173	\$7.30
8	matt gold	Zinc	-	-	-	-	106.70.172	\$7.40

Note
Refer to page 255 for matching appliance pulls.

1-6

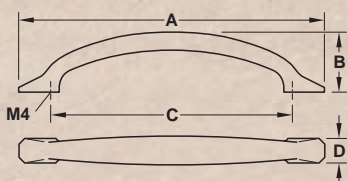

7-8

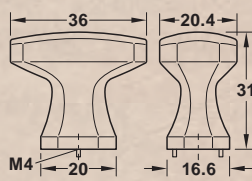



Paragon

BY HÄFELE

	Finish	Material	A	B	C	D	Item No.	SRP/pc.
1	oil-rubbed bronze	Zinc	-	-	-	-	102.64.100	\$18.38
2	polished nickel	Zinc	-	-	-	-	102.64.700	\$17.25
3	satin nickel	Zinc	-	-	-	-	102.64.600	\$18.03
4	satin nickel	Zinc	115	33	96	17	123.08.441	\$22.84
5	satin nickel	Zinc	147	33	128	17	123.08.442	\$26.28
6	satin nickel	Zinc	224	36	8"	19	123.08.443	\$37.48
7	oil-rubbed bronze	Zinc	115	33	96	17	123.08.141	\$24.96
8	oil-rubbed bronze	Zinc	147	33	128	17	123.08.142	\$27.26
9	oil-rubbed bronze	Zinc	224	36	8"	19	123.08.143	\$46.82
10	polished nickel	Zinc	224	36	8"	19	123.08.748	\$33.64
11	polished nickel	Zinc	147	33	128	17	123.08.747	\$23.02
12	polished nickel	Zinc	115	33	96	17	123.08.746	\$18.05

Note

Refer to page 256 for matching appliance pulls.

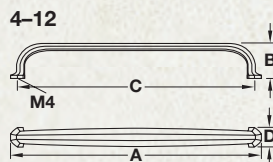
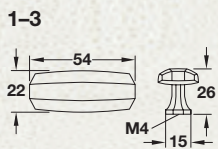



Art Deco/Glam

BY HÄFELE - 1-4

	Finish	Material	A	C	Item No.	SRP/pc.
1	polished chrome	Zinc	180	160	110.34.286	\$12.24
2	polished chrome	Zinc	212	192	110.34.287	\$11.75
3	brushed nickel	Zinc	212	192	110.34.687	\$11.71
4	brushed nickel	Zinc	180	160	110.34.686	\$12.28
5	polished chrome/polished gold	Brass	-	-	117.44.200	\$17.40

1-4

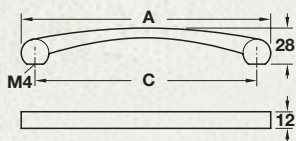

5

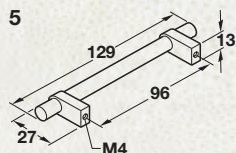

Dimensions in mm unless otherwise noted. Prices subject to change.



Zelda



	Finish	Material	A	B	C	D	Item No.	SRP/pc.
1	antique silver	Zinc	-	-	-	-	155.02.084	\$9.34
2	antique silver	Zinc	109	33	96	13	155.02.041	\$8.25
3	antique silver	Zinc	144	35	128	15	155.02.051	\$9.99
4	antique silver	Zinc	176	37	160	15	155.02.061	\$12.06
5	antique silver	Zinc	212	40	192	17	155.02.071	\$15.05
6	oil-rubbed bronze	Zinc	-	-	-	-	155.02.080	\$9.34
7	oil-rubbed bronze	Zinc	109	33	96	13	155.02.042	\$8.59
8	oil-rubbed bronze	Zinc	144	35	128	15	155.02.052	\$10.73
9	oil-rubbed bronze	Zinc	176	37	160	15	155.02.062	\$12.93
10	oil-rubbed bronze	Zinc	212	40	192	17	155.02.072	\$13.34

1, 6

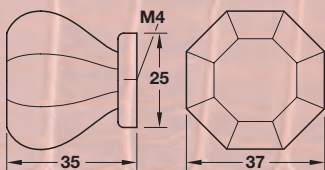

2-5, 7-10

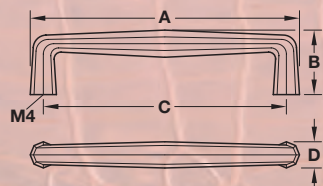



Zelda



	Finish	Material	A	B	C	D	Item No.	SRP/pc.
1	brushed brass	Zinc	-	-	-	-	155.02.081	\$9.34
2	brushed brass	Zinc	109	33	96	13	155.02.043	\$8.66
3	brushed brass	Zinc	144	35	128	15	155.02.053	\$10.43
4	brushed brass	Zinc	176	37	160	15	155.02.063	\$12.60
5	brushed brass	Zinc	212	40	192	17	155.02.073	\$16.01
6	polished nickel	Zinc	212	40	192	17	155.02.070	\$15.41
7	polished nickel	Zinc	176	37	160	15	155.02.060	\$12.20
8	polished nickel	Zinc	144	35	128	15	155.02.050	\$10.01
9	polished nickel	Zinc	109	33	96	13	155.02.040	\$8.18
10	polished nickel	Zinc	-	-	-	-	155.02.083	\$9.27

1, 10

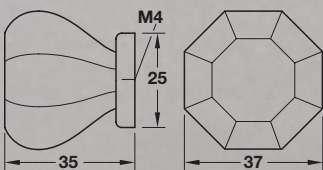

2-5, 6-9

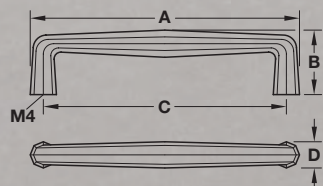

Dimensions in mm unless otherwise noted. Prices subject to change.



Art Deco/ Glam



	Finish	Material	A	B	C	Item No.	SRP/pc.
1	polished chrome, crystal elements	Zinc	-	-	-	111.25.262	\$135.22
2	polished chrome, crystal elements	Zinc	-	-	-	111.25.252	\$48.44
3	polished nickel, crystal elements	Zinc	-	-	-	132.19.710	\$53.96
4	polished nickel, crystal elements	Zinc	173	25	128	103.29.712	\$152.28
5	polished nickel, crystal elements	Zinc	136	21	96	103.29.711	\$115.58

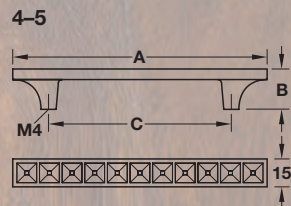
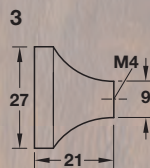
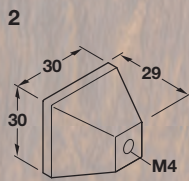
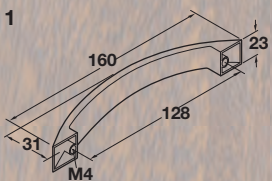



Crystalline* and Art Deco/Glam

	Finish	Material	Item No.	SRP/pc.
*1	clear/matt	Glass/Stainless Steel	103.79.401	\$65.04
*2	frosted/matt	Glass/Stainless Steel	103.79.411	\$71.84
*3	clear/matt	Glass/Stainless Steel	135.73.400	\$27.76
*4	frosted/matt	Glass/Stainless Steel	135.73.410	\$30.64
5	polished/polished chrome	Crystal/Zinc	139.60.422	\$57.64
6	polished/gold colored, polished	Crystal/Zinc	138.72.800	\$47.20

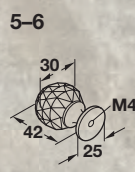
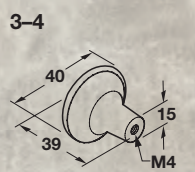
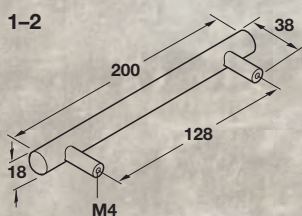

Dimensions in mm unless otherwise noted. Prices subject to change.



Carrione

BY AMEROCK

	Finish	Material	A	C	Item No.	SRP/pc.
1	marbleized white/polished nickel	Zinc	-	-	133.53.033	\$21.12
2	marbleized white/satin nickel	Zinc	-	-	133.53.104	\$25.34
3	marbleized white/black bronzed	Zinc	-	-	133.53.094	\$25.61
4	marbleized white/black bronzed	Zinc	160	96	133.53.095	\$48.07
5	marbleized white/polished nickel	Zinc	160	96	133.53.035	\$47.57
6	marbleized white/black bronzed	Zinc	191	128	133.53.096	\$56.06
7	marbleized white/satin nickel	Zinc	191	128	133.53.106	\$55.49
8	marbleized white/polished nickel	Zinc	191	128	133.53.036	\$55.49
9	marbleized white/black bronzed	Zinc	222	160	133.53.097	\$64.08
10	marbleized white/polished nickel	Zinc	222	160	133.53.103	\$63.46

Note
Supplied with 1" mounting screws.

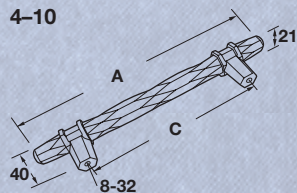
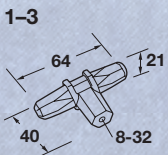



Carrione

BY AMEROCK

	Finish	Material	A	C	Item No.	SRP/pc.
1	marbleized white/oil-rubbed bronze	Zinc	160	96	133.53.037	\$47.57
2	marbleized white/gold champagne	Zinc	160	96	133.53.099	\$47.57
3	marbleized white/satin nickel	Zinc	160	96	133.53.105	\$47.57
4	marbleized white/oil-rubbed bronze	Zinc	222	160	133.53.102	\$63.46
5	marbleized white/gold champagne	Zinc	222	160	133.53.101	\$63.46
6	marbleized white/satin nickel	Zinc	222	160	133.53.107	\$63.46
7	marbleized white/gold champagne	Zinc	191	128	133.53.100	\$55.49
8	marbleized white/gold champagne	Zinc	-	-	133.53.098	\$25.34
9	marbleized white/oil-rubbed bronze	Zinc	191	128	133.53.038	\$55.49
10	marbleized white/oil-rubbed bronze	Zinc	-	-	133.53.034	\$21.12

Note
Supplied with 1" mounting screws.

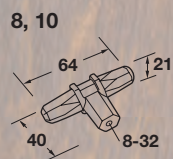
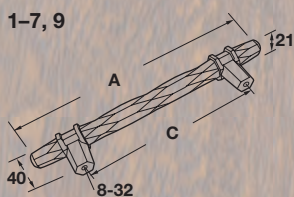

Dimensions in mm unless otherwise noted. Prices subject to change.

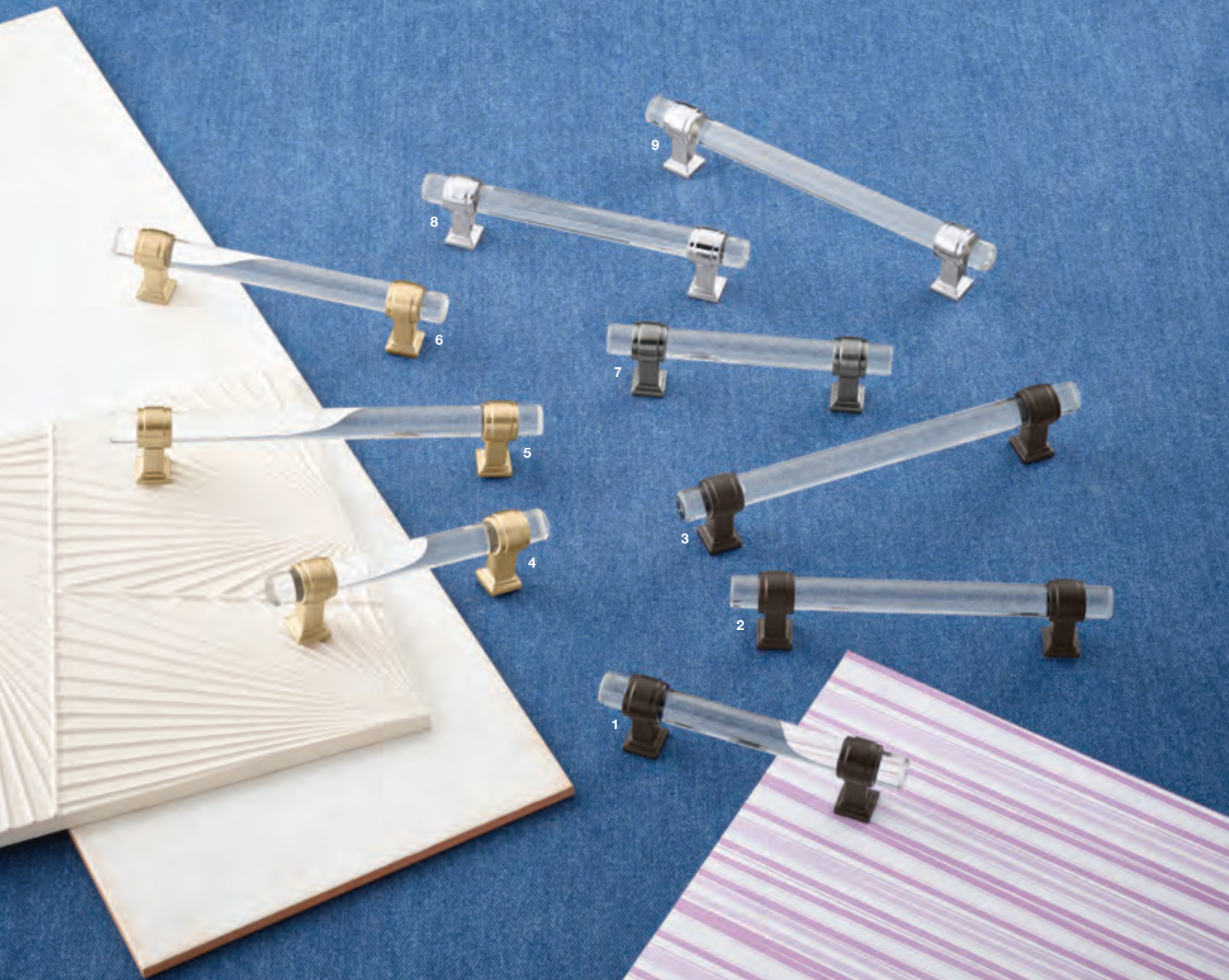

Glacio

BY AMEROCK

	Finish	Material	A	C	Item No.	SRP/pc.
1	black bronzed/clear	Zinc/Acrylic	135	96	133.53.127	\$44.35
2	black bronzed/clear	Zinc/Acrylic	167	128	133.53.128	\$53.23
3	black bronzed/clear	Zinc/Acrylic	200	160	133.53.129	\$68.98
4	gold champagne/clear	Zinc/Acrylic	135	96	133.53.130	\$44.35
5	gold champagne/clear	Zinc/Acrylic	200	160	133.53.132	\$68.98
6	gold champagne/clear	Zinc/Acrylic	167	128	133.53.131	\$53.23
7	gunmetal/clear	Zinc/Acrylic	135	96	133.53.133	\$44.35
8	polished nickel/clear	Zinc/Acrylic	167	128	133.53.039	\$53.23
9	polished nickel/clear	Zinc/Acrylic	200	160	133.53.040	\$68.95

Note
Supplied with 1" mounting screws.

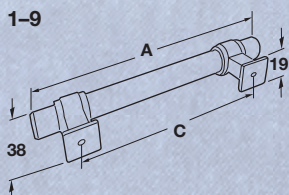



Glacio

BY AMEROCK

	Finish	Material	A	C	Item No.	SRP/pc.
1	satin nickel/clear	Zinc/Acrylic	135	96	133.53.140	\$44.35
2	satin nickel/clear	Zinc/Acrylic	167	128	133.53.141	\$53.23
3	satin nickel/clear	Zinc/Acrylic	200	160	133.53.142	\$68.98
4	polished nickel/clear	Zinc/Acrylic	135	96	133.53.139	\$44.35
5	gunmetal/clear	Zinc/Acrylic	167	128	133.53.134	\$53.23
6	gunmetal/clear	Zinc/Acrylic	200	160	133.53.135	\$68.98
7	oil-rubbed bronze/clear	Zinc/Acrylic	135	96	133.53.136	\$44.35
8	oil-rubbed bronze/clear	Zinc/Acrylic	167	128	133.53.137	\$53.23
9	oil-rubbed bronze/clear	Zinc/Acrylic	200	160	133.53.138	\$68.98

Note
Supplied with 1" mounting screws.

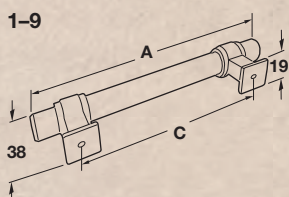

Dimensions in mm unless otherwise noted. Prices subject to change.



Glacio

BY AMEROCK

	Finish	Material	Item No.	SRP/pc.
1	gold champagne/clear	Aluminum/Synthetic Crystal	133.50.111	\$21.85
2	oil-rubbed bronze/clear	Aluminum/Synthetic Crystal	133.50.114	\$24.29
3	gunmetal/clear	Aluminum/Synthetic Crystal	133.50.117	\$21.85
4	gold champagne/clear	Aluminum/Synthetic Crystal	133.50.112	\$21.85
5	gunmetal/clear	Aluminum/Synthetic Crystal	133.50.115	\$24.29
6	oil-rubbed bronze/clear	Aluminum/Synthetic Crystal	133.50.118	\$21.85
7	gold champagne/clear	Aluminum/Synthetic Crystal	133.50.113	\$21.85
8	oil-rubbed bronze/clear	Aluminum/Synthetic Crystal	133.50.119	\$21.85
9	gunmetal/clear	Aluminum/Synthetic Crystal	133.50.116	\$24.29

Note
Supplied with 1" mounting screws.

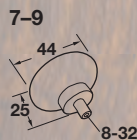
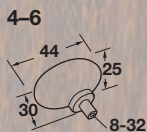



Abernathy and Glacio

BY AMEROCK

	Finish	Material	Item No.	SRP/pc.
1	oil-rubbed bronze	Zinc/Acrylic	133.50.109	\$17.59
2	antique silver	Zinc/Acrylic	133.50.108	\$17.59
3	satin nickel	Zinc/Acrylic	133.50.110	\$17.59
4	satin nickel/clear	Aluminum/Synthetic Crystal	133.50.123	\$21.85
5	polished nickel/clear	Aluminum/Synthetic Crystal	133.50.120	\$21.85
6	black bronzed/clear	Aluminum/Synthetic Crystal	133.53.126	\$21.65
7	satin nickel/clear	Aluminum/Synthetic Crystal	133.50.125	\$21.85
8	black bronzed/clear	Aluminum/Synthetic Crystal	133.53.125	\$21.65
9	polished nickel/clear	Aluminum/Synthetic Crystal	133.50.122	\$21.85
10	polished nickel/clear	Aluminum/Synthetic Crystal	133.50.121	\$21.85
11	satin nickel/clear	Aluminum/Synthetic Crystal	133.50.124	\$21.85
12	black bronzed/clear	Aluminum/Synthetic Crystal	133.53.124	\$21.65

Note
Supplied with 1" mounting screws.

1-3



4-6



7-9

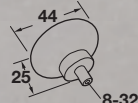

10-12



Dimensions in mm unless otherwise noted. Prices subject to change.



Crawford

BY AMEROCK

	Finish	Material	A	B	C	D	Item No.	SRP/pc.
1	oil-rubbed bronze	Zinc	119	35	96	19	133.50.258	\$15.71
2	oil-rubbed bronze	Zinc	187	41	160	22	133.50.257	\$19.59
3	oil-rubbed bronze	Zinc	154	37	128	21	133.50.256	\$24.67
4	gold champagne	Zinc	119	35	96	19	133.50.255	\$21.11
5	gold champagne	Zinc	154	37	128	21	133.50.253	\$21.04
6	gold champagne	Zinc	187	41	160	22	133.50.254	\$26.42
7	gold champagne	Zinc	35	-	-	30	133.50.303	\$17.59

Note
Supplied with 1" mounting screws.

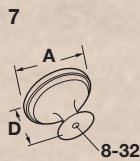
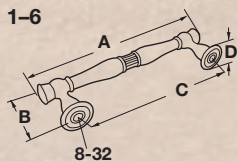



Crawford

BY AMEROCK

	Finish	Material	A	B	C	D	Item No.	SRP/pc.
1	satin nickel	Zinc	154	37	128	21	133.50.259	\$24.67
2	satin nickel	Zinc	119	35	96	19	133.50.261	\$15.71
3	satin nickel	Zinc	187	41	160	22	133.50.260	\$19.44
4	satin nickel	Zinc	–	–	–	–	133.50.307	\$13.17
5	oil-rubbed bronze	Zinc	–	–	–	–	133.50.305	\$13.17

Note
Supplied with 1" mounting screws.

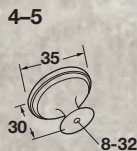
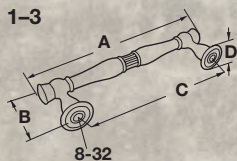



Carolyne

BY AMEROCK

	Finish	Material	A	B	C	Item No.	SRP/pc.
1	satin nickel	Zinc	173	32	128	133.50.203	\$18.29
2	satin nickel	Zinc	141	27	96	133.50.204	\$19.20
3	polished nickel	Zinc	173	32	128	133.50.201	\$20.17
4	satin nickel	Zinc	-	-	-	133.50.250	\$15.20

Note

Supplied with 1" mounting screws.

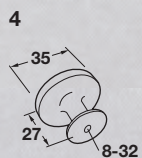
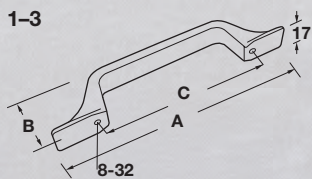



Mulholland

BY AMEROCK

ADA 4-9

	Finish	Material	A	B	C	D	Item No.	SRP/pc.
1	gold champagne	Zinc	32	-	-	21	133.53.182	\$10.64
2	gold champagne	Zinc	38	-	-	21	133.53.188	\$21.68
3	gold champagne	Zinc	95	27	76 (3")	17	133.53.183	\$12.42
4	gold champagne	Zinc	116	29	96	21	133.53.184	\$14.20
5	gold champagne	Zinc	149	32	128	22	133.53.185	\$15.94
6	gold champagne	Zinc	181	37	160	22	133.53.186	\$19.70
7	polished nickel	Zinc	181	37	160	22	133.53.193	\$17.59
8	polished nickel	Zinc	149	32	128	22	133.53.192	\$15.94
9	polished nickel	Zinc	116	29	96	21	133.53.191	\$14.20
10	polished nickel	Zinc	95	27	76 (3")	17	133.53.190	\$12.42
11	polished nickel	Zinc	38	-	-	21	133.53.195	\$19.37
12	polished nickel	Zinc	32	-	-	21	133.53.189	\$10.64

Note

Supplied with 1" mounting screws. Refer to page 265 for matching appliance pulls.

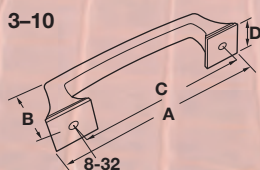
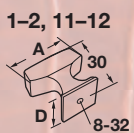



Mulholland

BY AMEROCK

ADA 2-7

	Finish	Material	A	B	C	D	Item No.	SRP/pc.
1	oil-rubbed bronze	Zinc	95	27	76 (3")	17	133.50.348	\$12.42
2	oil-rubbed bronze	Zinc	116	29	96	21	133.50.349	\$14.20
3	oil-rubbed bronze	Zinc	149	32	128	22	133.50.346	\$15.94
4	oil-rubbed bronze	Zinc	181	37	160	22	133.50.347	\$15.84
5	satin nickel	Zinc	181	37	160	22	133.50.351	\$15.84
6	satin nickel	Zinc	149	32	128	22	133.50.350	\$15.94
7	satin nickel	Zinc	116	29	96	21	133.50.353	\$14.20
8	satin nickel	Zinc	95	27	76 (3")	17	133.50.352	\$12.42
9	oil-rubbed bronze	Zinc	32	-	-	21	133.50.611	\$10.64
10	oil-rubbed bronze	Zinc	38	-	-	21	133.50.612	\$19.53

Note
Supplied with 1" mounting screws. Refer to page 265 for matching appliance pulls.

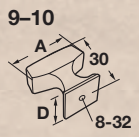
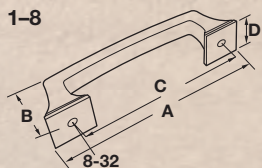

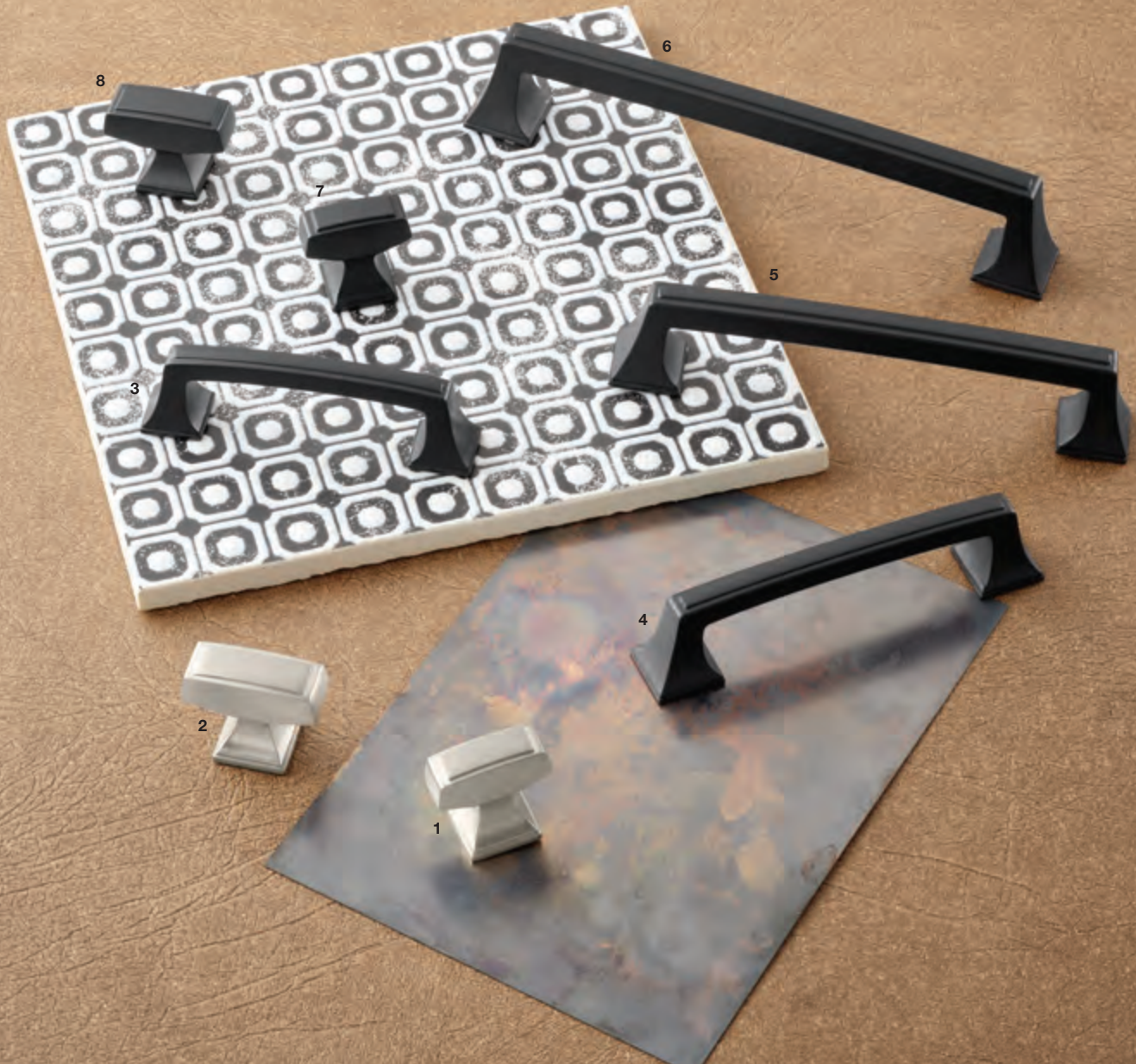

Mulholland

BY AMEROCK

ADA 4-6

	Finish	Material	A	B	C	D	Item No.	SRP/pc.
1	satin nickel	Zinc	32	-	-	21	133.50.613	\$10.64
2	satin nickel	Zinc	38	-	-	21	133.50.614	\$19.53
3	black bronzed	Zinc	95	27	76 (3")	17	133.53.176	\$12.42
4	black bronzed	Zinc	116	29	96	21	133.53.177	\$14.20
5	black bronzed	Zinc	149	32	128	22	133.53.178	\$15.94
6	black bronzed	Zinc	181	37	160	22	133.53.179	\$19.70
7	black bronzed	Zinc	32	-	-	21	133.53.175	\$10.64
8	black bronzed	Zinc	38	-	-	21	133.53.181	\$21.68

Note

Supplied with 1" mounting screws. Refer to page 265 for matching appliance pulls.

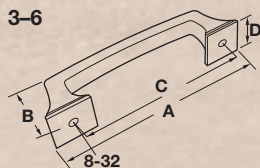
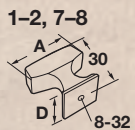



Grace Revitalize

BY AMEROCK

	Finish	Material	A	B	Item No.	SRP/pc.
1	gold champagne	Zinc	35	30	133.50.323	\$14.20
2	gold champagne	Zinc	44	35	133.50.324	\$17.76
3	polished nickel	Zinc	35	30	133.50.327	\$15.77
4	satin nickel	Zinc	35	30	133.50.329	\$14.20
5	polished nickel	Zinc	44	35	133.50.328	\$16.83
6	satin nickel	Zinc	44	35	133.50.330	\$17.76
7	oil-rubbed bronze	Zinc	44	35	133.50.326	\$17.76
8	oil-rubbed bronze	Zinc	35	30	133.50.325	\$14.20

Note
Supplied with 1" mounting screws.

1-8

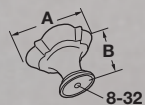



Traditional Classics

BY AMEROCK

	Finish	Material	Item No.	SRP/pc.
1	gold champagne/clear	Zinc/Glass	133.50.127	\$14.23
2	oil-rubbed bronze/clear	Zinc/Glass	133.50.131	\$14.23
3	polished nickel/clear	Zinc/Glass	133.50.132	\$14.23
4	gilded bronze/clear	Zinc/Glass	133.50.130	\$15.84
5	satin nickel/clear	Zinc/Glass	133.50.133	\$14.23
6	black bronzed/clear	Zinc/Glass	133.50.129	\$15.84

Note
Supplied with 1" mounting screws.

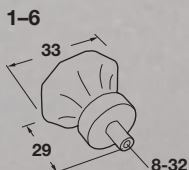

Dimensions in mm unless otherwise noted. Prices subject to change.

TRANSITIONAL

Just right. Not too fancy. Not too edgy. Transitional style is a masterful blend of classic and modern elements that create a setting neither overwhelmed by a single motif nor the clashing of too many styles. Transitional deco provides a bridge for room updates between remodels.





Transitional **NEW**

BY HÄFELE

	Finish	Material	A	C	Item No.	SRP/pc.
1	matt black	Zinc	141	96	106.70.100	\$8.48
2	brushed nickel	Zinc	141	96	106.70.106	\$10.36
3	matt gold	Zinc	141	96	106.70.109	\$11.23
4	matt black	Zinc	205	160	106.70.102	\$10.92
5	brushed nickel	Zinc	205	160	106.70.108	\$13.74
6	matt gold	Zinc	205	160	106.70.111	\$15.21
7	matt gold	Zinc	173	128	106.70.110	\$13.58
8	brushed nickel	Zinc	173	128	106.70.107	\$12.89
9	matt black	Zinc	173	128	106.70.101	\$10.13
10	matt black	Zinc	-	-	106.70.120	\$3.71
11	brushed nickel	Zinc	-	-	106.70.122	\$5.33
12	matt gold	Zinc	-	-	106.70.123	\$6.12

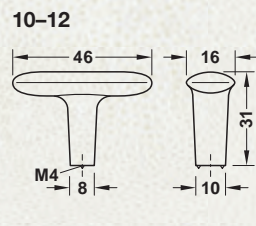
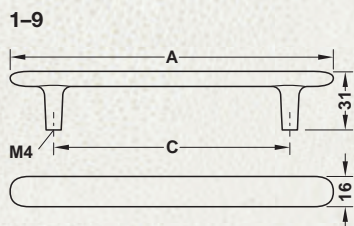



Transitional

	Finish	Material	A	C	Item No.	SRP/pc.
1	brushed nickel	Zinc	-	-	123.08.631	\$20.38
2	brushed nickel	Zinc	177	128	123.08.602	\$18.98
3	brushed nickel	Zinc	120	3"	123.08.610	\$12.26
4	brushed nickel	Zinc	-	-	123.08.641	\$14.16
5	satin nickel	Zinc	-	-	107.04.602	\$33.74
6	stainless steel	Zinc	-	-	103.78.026	\$15.97
7	matt nickel	Zinc	-	-	104.35.600	\$8.77
8	matt nickel	Zinc	-	-	104.37.600	\$4.34

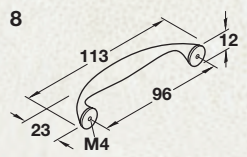
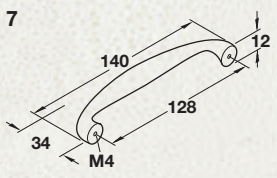
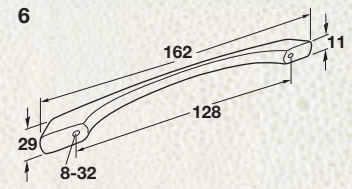
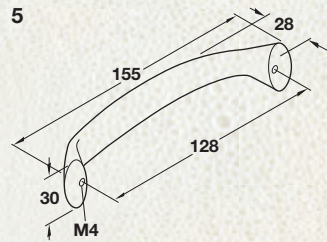
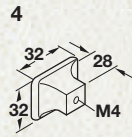
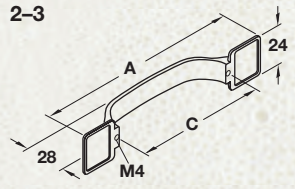
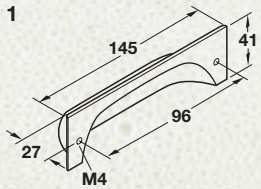

Dimensions in mm unless otherwise noted. Prices subject to change.



Candler

BY AMEROCK

ADA 1, 9-10

	Finish	Material	A	B	C	D	Item No.	SRP/pc.
1	antique silver	Zinc	202	33	160	24	133.50.184	\$14.23
2	antique silver	Zinc	132	30	96	19	133.50.186	\$12.42
3	antique silver	Zinc	38	32	-	32	133.50.238	\$12.42
4	antique silver	Zinc	32	25	-	29	133.50.237	\$8.87
5	oil-rubbed bronze	Zinc	32	25	-	29	133.50.239	\$8.87
6	oil-rubbed bronze	Zinc	38	32	-	32	133.50.240	\$12.42
7	oil-rubbed bronze	Zinc	111	29	76 (3")	19	133.50.189	\$10.64
8	oil-rubbed bronze	Zinc	132	30	96	19	133.50.190	\$12.42
9	oil-rubbed bronze	Zinc	167	32	128	21	133.50.187	\$14.20
10	oil-rubbed bronze	Zinc	202	33	160	24	133.50.188	\$14.23

Note

Supplied with 1" mounting screws. Refer to page 266 for matching appliance pulls.

1-2, 7-10

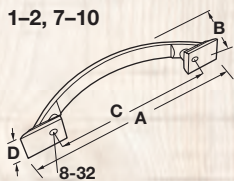

3-6

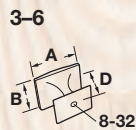



Candler

BY AMEROCK

ADA 2-4, 7

	Finish	Material	A	B	C	D	Item No.	SRP/pc.
1	antique silver	Zinc	111	29	76 (3")	19	133.50.185	\$10.64
2	antique silver	Zinc	167	32	128	21	133.50.183	\$14.20
3	polished nickel	Zinc	202	33	160	24	133.50.192	\$14.23
4	polished nickel	Zinc	167	32	128	21	133.50.191	\$14.20
5	polished nickel	Zinc	132	30	96	19	133.50.194	\$12.42
6	polished nickel	Zinc	111	29	76 (3")	19	133.50.193	\$10.64
7	satin nickel	Zinc	167	32	128	21	133.50.195	\$14.20
8	satin nickel	Zinc	132	30	96	19	133.50.198	\$12.42
9	satin nickel	Zinc	111	29	76 (3")	19	133.50.197	\$10.64

Note

Supplied with 1" mounting screws. Refer to page 266 for matching appliance pulls.

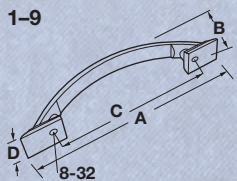

Dimensions in mm unless otherwise noted. Prices subject to change.



Candler

BY AMEROCK

ADA 3

	Finish	Material	A	B	C	D	Item No.	SRP/pc.
1	satin nickel	Zinc	38	32	-	32	133.50.244	\$12.42
2	satin nickel	Zinc	32	25	-	29	133.50.243	\$8.87
3	satin nickel	Zinc	202	24	160	33	133.50.196	\$14.23
4	black bronzed	Zinc	132	19	96	30	133.53.080	\$12.42
5	black bronzed	Zinc	111	19	76 (3")	29	133.53.079	\$10.64
6	black bronzed	Zinc	32	25	-	29	133.53.078	\$8.87
7	polished nickel	Zinc	32	25	-	29	133.50.241	\$8.87
8	polished nickel	Zinc	38	32	-	32	133.50.242	\$12.42

Note

Supplied with 1" mounting screws. Refer to page 266 for matching appliance pulls.

1-2, 6-8

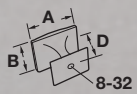

3-5

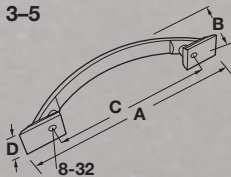



Candler

BY AMEROCK

ADA 6-9

	Finish	Material	A	B	C	D	Item No.	SRP/pc.
1	black bronzed	Zinc	38	32	-	32	133.53.084	\$13.80
2	gold champagne	Zinc	32	25	-	29	133.53.085	\$8.87
3	gold champagne	Zinc	38	32	-	32	133.53.091	\$13.80
4	gold champagne	Zinc	111	19	76 (3")	29	133.53.086	\$10.64
5	gold champagne	Zinc	132	19	96	30	133.53.087	\$12.42
6	gold champagne	Zinc	167	21	128	32	133.53.088	\$14.20
7	gold champagne	Zinc	202	24	160	33	133.53.089	\$17.72
8	black bronzed	Zinc	202	24	160	33	133.53.082	\$17.72
9	black bronzed	Zinc	167	21	128	32	133.53.081	\$14.20

Note

Supplied with 1" mounting screws. Refer to page 266 for matching appliance pulls.

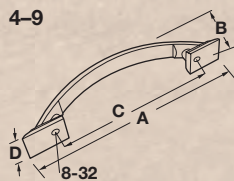
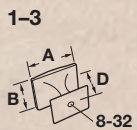

Dimensions in mm unless otherwise noted. Prices subject to change.



Davenport

BY AMEROCK

	Finish	Material	A	B	C	D	Item No.	SRP/pc.
1	gunmetal	Zinc	135	–	96	–	133.50.268	\$20.61
2	gunmetal	Zinc	167	–	128	–	133.50.266	\$22.19
3	gunmetal	Zinc	198	–	160	–	133.50.267	\$23.76
4	oil-rubbed bronze	Zinc	198	–	160	–	133.50.270	\$26.42
5	oil-rubbed bronze	Zinc	167	–	128	–	133.50.269	\$24.67
6	oil-rubbed bronze	Zinc	135	–	96	–	133.50.271	\$22.89
7	gunmetal	Zinc	32	30	–	25	133.50.309	\$15.84
8	gunmetal	Zinc	38	35	–	32	133.50.310	\$18.99

Note
Supplied with 1" mounting screws.

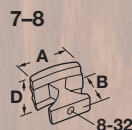
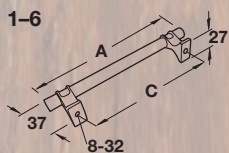



Davenport

BY AMEROCK

	Finish	Material	A	B	C	D	Item No.	SRP/pc.
1	satin nickel	Zinc	198	-	160	-	133.50.273	\$23.76
2	satin nickel	Zinc	167	-	128	-	133.50.272	\$22.19
3	satin nickel	Zinc	135	-	96	-	133.50.274	\$20.61
4	satin nickel	Zinc	32	30	-	25	133.50.313	\$15.84
5	satin nickel	Zinc	38	35	-	32	133.50.314	\$18.99
6	oil-rubbed bronze	Zinc	32	30	-	25	133.50.311	\$17.59
7	oil-rubbed bronze	Zinc	38	35	-	32	133.50.312	\$21.11

Note
Supplied with 1" mounting screws.

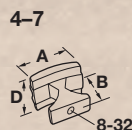
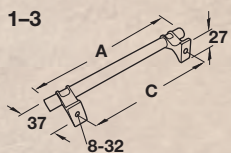

Dimensions in mm unless otherwise noted. Prices subject to change.



St. Vincent

BY AMEROCK

	Finish	Material	A	C	Item No.	SRP/pc.
1	gold champagne	Zinc	160	96	133.50.384	\$20.33
2	gold champagne	Zinc	191	128	133.50.382	\$25.01
3	gold champagne	Zinc	222	160	133.50.383	\$29.59
4	satin nickel	Zinc	222	160	133.50.392	\$30.17
5	satin nickel	Zinc	191	128	133.50.391	\$25.34
6	satin nickel	Zinc	160	96	133.50.393	\$21.14
7	satin nickel	Zinc	-	-	133.50.642	\$15.84
8	gold champagne	Zinc	-	-	133.50.639	\$15.80

Note
Supplied with 1" mounting screws.

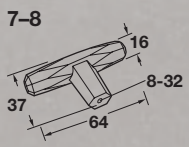
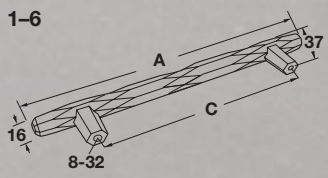



St. Vincent

BY AMEROCK

- | | Finish |
|---|-------------------|
| 1 | oil-rubbed bronze |
| 2 | polished nickel |
| 3 | polished nickel |
| 4 | polished nickel |
| 5 | polished nickel |
| 6 | oil-rubbed bronze |
| 7 | oil-rubbed bronze |
| 8 | oil-rubbed bronze |

Material	A	C	Item No.	SRP/pc.
Zinc	-	-	133.50.640	\$15.84
Zinc	-	-	133.50.641	\$15.80
Zinc	160	96	133.50.390	\$20.33
Zinc	191	128	133.50.388	\$25.01
Zinc	222	160	133.50.389	\$29.59
Zinc	222	160	133.50.386	\$30.17
Zinc	191	128	133.50.385	\$25.34
Zinc	160	96	133.50.387	\$20.61

Note
Supplied with 1" mounting screws.

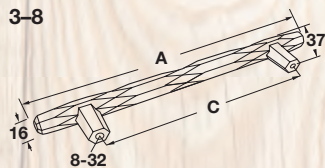
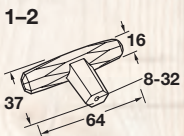

Dimensions in mm unless otherwise noted. Prices subject to change.



Westerly

BY AMEROCK

ADA 3-8

	Finish	Material	A	B	C	D	Item No.	SRP/pc.
1	satin nickel	Zinc	-	-	-	-	133.50.651	\$9.50
2	black bronzed	Zinc	-	-	-	-	133.53.213	\$9.50
3	black bronzed	Zinc	159	33	128	14	133.53.215	\$14.23
4	satin nickel	Zinc	159	33	128	14	133.50.606	\$14.23
5	black bronzed	Zinc	192	35	160	16	133.53.216	\$17.59
6	satin nickel	Zinc	192	35	160	16	133.50.607	\$15.84
7	satin nickel	Zinc	129	33	96	14	133.50.608	\$12.66
8	black bronzed	Zinc	129	33	96	14	133.53.214	\$12.66

Note

Supplied with 1" mounting screws. Refer to page 267 for matching appliance pulls.

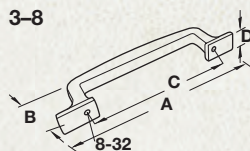
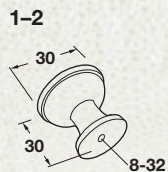



Westerly

BY AMEROCK

ADA 2-4, 6-8

	Finish	Material	A	B	C	D	Item No.	SRP/pc.
1	polished nickel	Zinc	-	-	-	-	133.53.223	\$9.50
2	polished nickel	Zinc	129	33	96	14	133.53.224	\$12.66
3	polished nickel	Zinc	159	33	128	14	133.53.225	\$14.23
4	polished nickel	Zinc	192	35	160	16	133.53.226	\$17.59
5	gold champagne	Zinc	-	-	-	-	133.53.218	\$9.50
6	gold champagne	Zinc	129	33	96	14	133.53.219	\$12.66
7	gold champagne	Zinc	159	33	128	14	133.53.220	\$14.23
8	gold champagne	Zinc	192	35	160	16	133.53.221	\$17.59

Note

Supplied with 1" mounting screws. Refer to page 267 for matching appliance pulls.

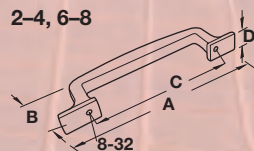
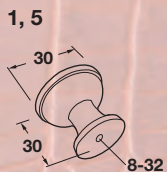

Dimensions in mm unless otherwise noted. Prices subject to change.



Exceed **NEW**

BY AMEROCK

ADA 5-8

	Finish	Material	A	C	Item No.	SRP/pc.
1	satin nickel	Zinc	-	-	133.53.500	\$14.23
2	champagne bronze	Zinc	-	-	133.53.329	\$14.23
3	polished chrome	Zinc	-	-	133.53.446	\$15.84
4	matt black	Zinc	-	-	133.53.389	\$12.95
5	matt black	Zinc	249	224	133.53.393	\$40.51
6	satin nickel	Zinc	249	224	133.53.504	\$40.51
7	polished chrome	Zinc	249	224	133.53.450	\$40.51
8	champagne bronze	Zinc	249	224	133.53.333	\$40.51

Note
Supplied with 1" mounting screws.

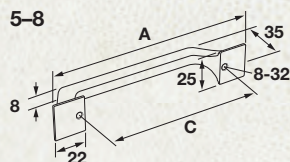
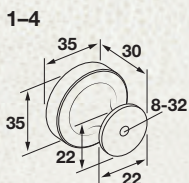



Exceed NEW

BY AMEROCK

ADA

	Finish	Material	A	C	Item No.	SRP/pc.
1	satin nickel	Zinc	133	96	133.53.501	\$20.61
2	satin nickel	Zinc	152	128	133.53.502	\$26.95
3	satin nickel	Zinc	184	160	133.53.503	\$30.17
4	champagne bronze	Zinc	133	96	133.53.330	\$20.61
5	champagne bronze	Zinc	152	128	133.53.331	\$26.95
6	champagne bronze	Zinc	184	160	133.53.332	\$30.17
7	polished chrome	Zinc	133	96	133.53.447	\$22.89
8	polished chrome	Zinc	152	128	133.53.448	\$29.95
9	polished chrome	Zinc	184	160	133.53.449	\$33.48
10	matt black	Zinc	133	96	133.53.390	\$20.61
11	matt black	Zinc	152	128	133.53.391	\$26.95
12	matt black	Zinc	184	160	133.53.392	\$30.17

Note
Supplied with 1" mounting screws.

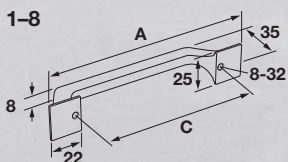



Stature **NEW**

BY AMEROCK

ADA 7-9

	Finish	Material	A	C	Item No.	SRP/pc.
1	champagne bronze	Zinc	-	-	133.53.298	\$17.59
2	matt black	Zinc	-	-	133.53.356	\$17.59
3	satin nickel	Zinc	-	-	133.53.468	\$17.59
4	champagne bronze	Zinc	-	-	133.53.297	\$11.08
5	satin nickel	Zinc	-	-	133.53.467	\$11.08
6	matt black	Zinc	-	-	133.53.355	\$11.08
7	champagne bronze	Zinc	243	224	133.53.337	\$38.78
8	satin nickel	Zinc	243	224	133.53.508	\$38.78
9	matt black	Zinc	243	224	133.53.397	\$38.78

Note
Supplied with 1" mounting screws.

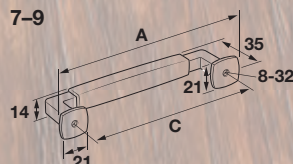
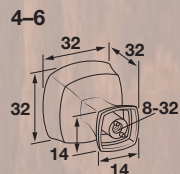
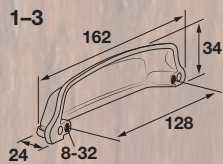



Stature NEW

BY AMEROCK

ADA

	Finish	Material	A	C	Item No.	SRP/pc.
1	champagne bronze	Zinc	116	96	133.53.334	\$18.99
2	champagne bronze	Zinc	148	128	133.53.335	\$25.34
3	champagne bronze	Zinc	179	160	133.53.336	\$28.56
4	matt black	Zinc	116	96	133.53.394	\$18.99
5	matt black	Zinc	148	128	133.53.395	\$23.01
6	matt black	Zinc	179	160	133.53.396	\$28.56
7	satin nickel	Zinc	116	96	133.53.505	\$18.99
8	satin nickel	Zinc	148	128	133.53.506	\$23.01
9	satin nickel	Zinc	179	160	133.53.507	\$28.56

Note
Supplied with 1" mounting screws.

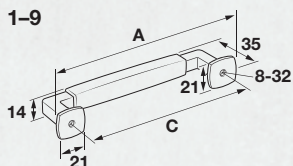

Dimensions in mm unless otherwise noted. Prices subject to change.



Surpass **NEW**

BY AMEROCK

ADA 2-4, 6-8

	Finish	Material	A	C	Item No.	SRP/pc.
1	matt black	Zinc	-	-	133.53.398	\$15.84
2	matt black	Zinc	116	96	133.53.399	\$19.37
3	matt black	Zinc	148	128	133.53.400	\$26.42
4	matt black	Zinc	179	160	133.53.401	\$29.95
5	champagne bronze	Zinc	-	-	133.53.338	\$15.84
6	champagne bronze	Zinc	116	96	133.53.339	\$19.37
7	champagne bronze	Zinc	148	128	133.53.340	\$26.42
8	champagne bronze	Zinc	179	160	133.53.341	\$29.95

Note
Supplied with 1" mounting screws.

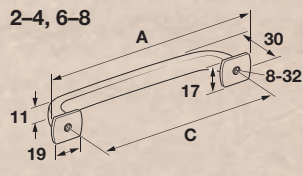
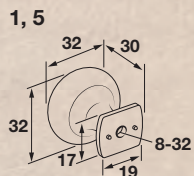



Surpass **NEW**

BY AMEROCK

ADA 2-4, 6-8

	Finish	Material	A	C	Item No.	SRP/pc.
1	satin nickel	Zinc	-	-	133.53.509	\$15.84
2	satin nickel	Zinc	116	96	133.53.510	\$19.37
3	satin nickel	Zinc	148	128	133.53.511	\$26.42
4	satin nickel	Zinc	179	160	133.53.512	\$29.95
5	polished chrome	Zinc	-	-	133.53.451	\$15.84
6	polished chrome	Zinc	116	96	133.53.452	\$19.37
7	polished chrome	Zinc	148	128	133.53.453	\$26.42
8	polished chrome	Zinc	179	160	133.53.454	\$29.95

Note
Supplied with 1" mounting screws.

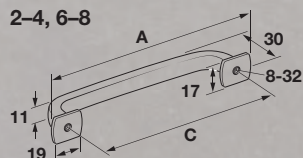
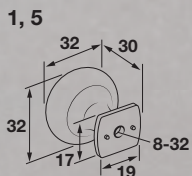

Dimensions in mm unless otherwise noted. Prices subject to change.



Extensity

BY AMEROCK

	Finish	Material	Item No.	SRP/pc.
1	satin nickel	Zinc	133.50.279	\$7.92
2	antique silver	Zinc	133.50.277	\$8.80
3	oil-rubbed bronze	Zinc	133.50.278	\$8.87
4	oil-rubbed bronze	Zinc	133.50.281	\$7.08
5	antique silver	Zinc	133.50.280	\$7.86
6	satin nickel	Zinc	133.50.282	\$7.08

Note
Supplied with 1" mounting screws.

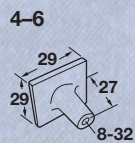
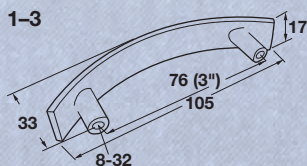



Allison

BY AMEROCK

	Finish	Material	Item No.	SRP/pc.
1	satin nickel	Zinc	133.50.157	\$4.03
2	satin nickel	Zinc	133.50.159	\$5.31
3	oil-rubbed bronze	Zinc	133.50.212	\$4.13
4	black matt	Zinc	133.50.208	\$4.13
5	satin nickel	Zinc	133.50.218	\$4.13
6	satin nickel	Zinc	133.50.217	\$4.74
7	antique silver	Zinc	133.50.205	\$4.74
8	oil-rubbed bronze	Zinc	133.50.211	\$4.74
9	black matt	Zinc	133.50.207	\$4.74
10	polished chrome	Zinc	133.50.215	\$4.74

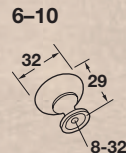
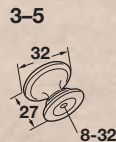
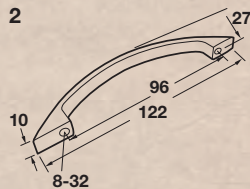
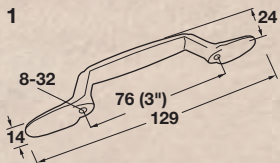

Dimensions in mm unless otherwise noted. Prices subject to change.

CONTEMPORARY

Contemporary styles eschew ornate dust-catchers, or a frilly filigree. Pulls are sleek, simple and direct; 90° angles are the norm. Knobs are guileless; rooted in their pure purpose. Contemporary styles continually evolve and currently showcase stone, wood and matt black finishes while material stalwarts include polished nickel and stainless steel.







Munich NEW

BY HÄFELE

	Finish	Material	A	C	Item No.	SRP/pc.
1	matt gold	Zinc	170	160	110.29.260	\$15.16
2	matt gold	Zinc	330	320	110.29.261	\$25.08
3	polished chrome	Zinc	330	320	110.29.259	\$25.36
4	polished chrome	Zinc	170	160	110.29.256	\$15.16

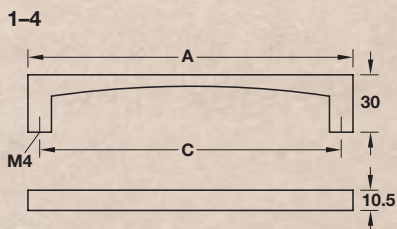



Munich NEW

BY HÄFELE

	Finish	Material	A	C	Item No.	SRP/pc.
1	matt black	Zinc	170	160	110.29.356	\$13.59
2	matt black	Zinc	330	320	110.29.358	\$22.72
3	stainless steel	Zinc	330	320	110.29.659	\$25.36
4	stainless steel	Zinc	170	160	110.29.656	\$15.16

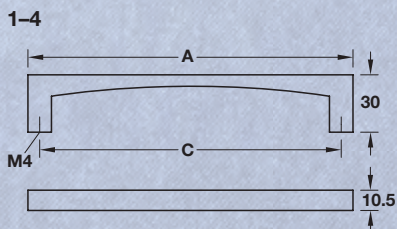

Dimensions in mm unless otherwise noted. Prices subject to change.



Contemporary

BY HÄFELE - 1-4

	Finish	Material	A	B	C	D	Item No.	SRP/pc.
1	polished chrome	Zinc	172	-	160	-	106.69.276	\$16.71
2	brushed nickel	Zinc	172	-	160	-	106.69.676	\$18.32
3	polished chrome	Zinc	204	-	192	-	106.69.277	\$18.95
4	brushed nickel	Zinc	204	-	192	-	106.69.677	\$20.76
5	matt nickel	Zinc	208	33	192	11	109.60.605	\$25.10
6	matt nickel	Zinc	140	32	128	9	109.60.603	\$23.08
7	matt nickel, antimicrobial	Zinc	140	32	128	9	109.60.625	\$16.30
8	matt nickel	Zinc	109	30	96	9	109.60.602	\$20.88

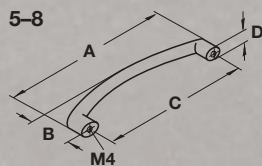
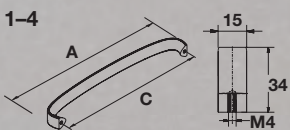



Contemporary

BY HÄFELE - 3-4

	Finish	Material	Item No.	SRP/pc.
1	black matt	Zinc	117.95.330	\$7.74
2	stainless steel look	Zinc	117.95.630	\$11.26
3	brushed nickel	Zinc	110.34.616	\$14.20
4	polished chrome	Zinc	110.34.216	\$14.34
5	matt	Stainless Steel	117.50.610	\$35.90
6	matt nickel	Zinc	110.20.603	\$14.29
7	matt black	Zinc	102.47.319	\$14.38

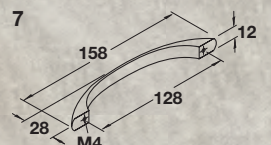
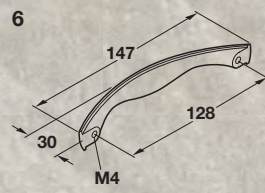
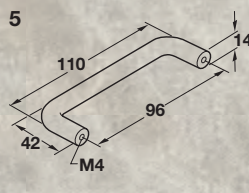
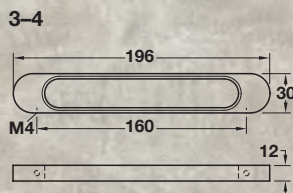
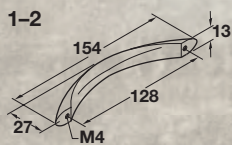

Dimensions in mm unless otherwise noted. Prices subject to change.



Contemporary



	Finish	Material	A	C	C1	Item No.	SRP/pc.
1	matt aluminum	Aluminum	240	210	–	155.00.984	\$63.18
2	matt aluminum	Aluminum	290	260	–	155.00.985	\$66.80
3	matt aluminum	Aluminum	318	288	–	155.00.986	\$70.42
4	matt aluminum	Aluminum	478	448	–	155.00.991	\$106.88
5	matt aluminum	Aluminum	590	560	–	155.00.993	\$144.84
6	matt aluminum	Aluminum	790	760	380	155.00.995	\$187.08
7	matt aluminum	Aluminum	690	660	–	155.00.994	\$163.44
8	matt aluminum	Aluminum	382	352	–	155.00.988	\$78.30

Note

With loose base, 2 fixing options of handle.

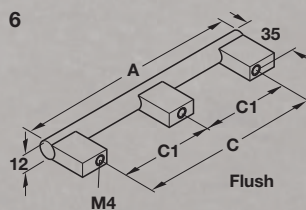
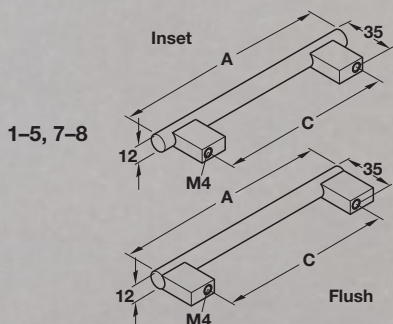

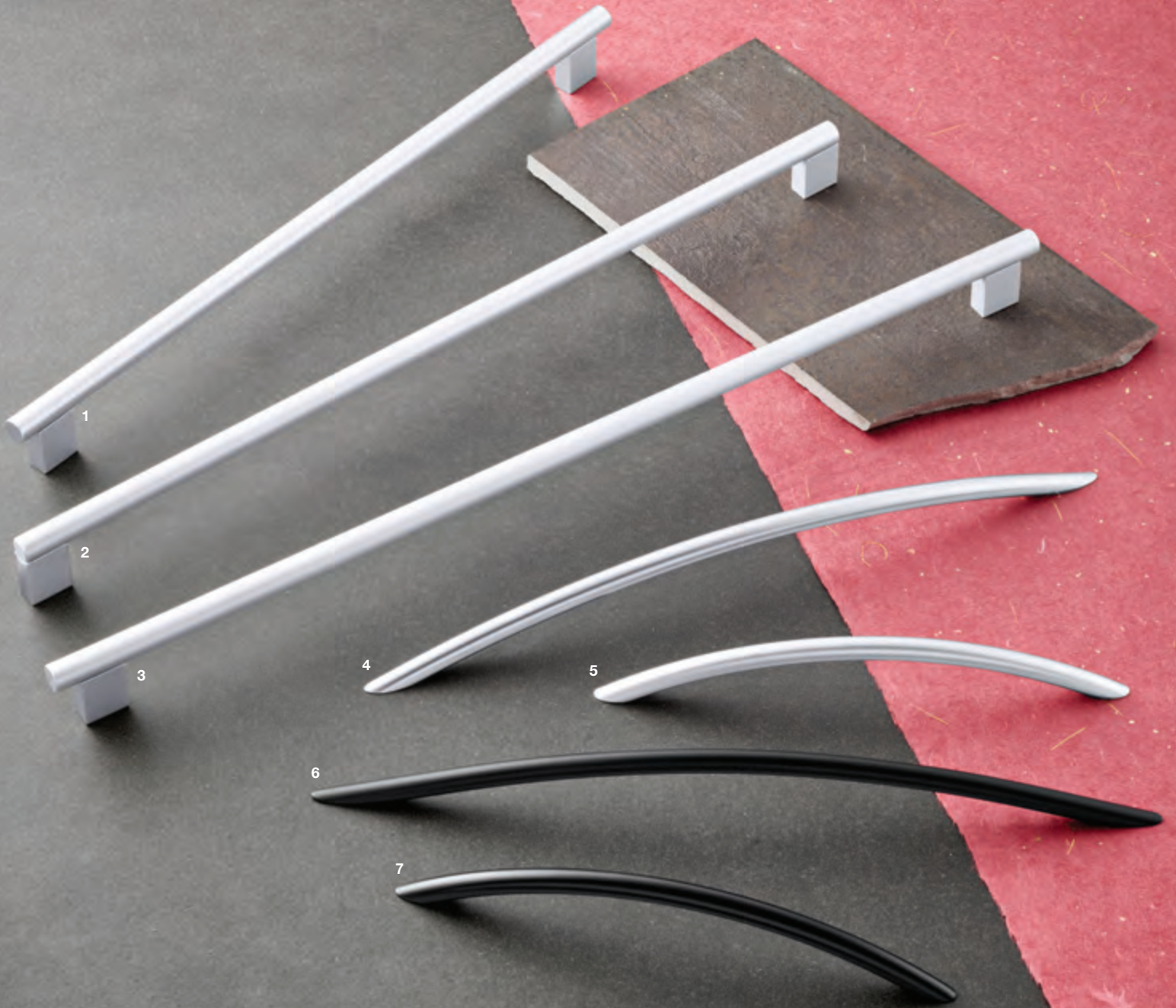

Contemporary



	Finish	Material	A	B	C	Item No.	SRP/pc.
1	matt aluminum	Aluminum	390	-	360	155.00.989	\$113.38
2	matt aluminum	Aluminum	440	-	410	155.00.990	\$111.46
3	matt aluminum	Aluminum	490	-	460	155.00.992	\$129.48
4	matt chrome	Steel	332	31	288	155.00.835	\$15.52
5	matt chrome	Steel	221	32	192	155.00.833	\$11.28
6	black matt	Steel	332	31	288	155.00.885	\$7.72
7	black matt	Steel	221	32	192	155.00.883	\$5.39

Note

1-3 with loose base, 2 fixing options of handle.

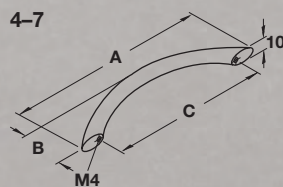
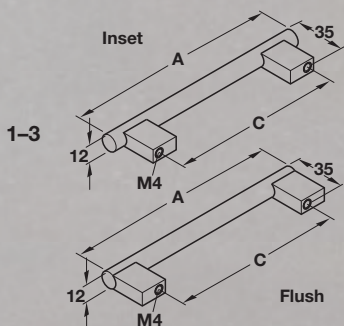

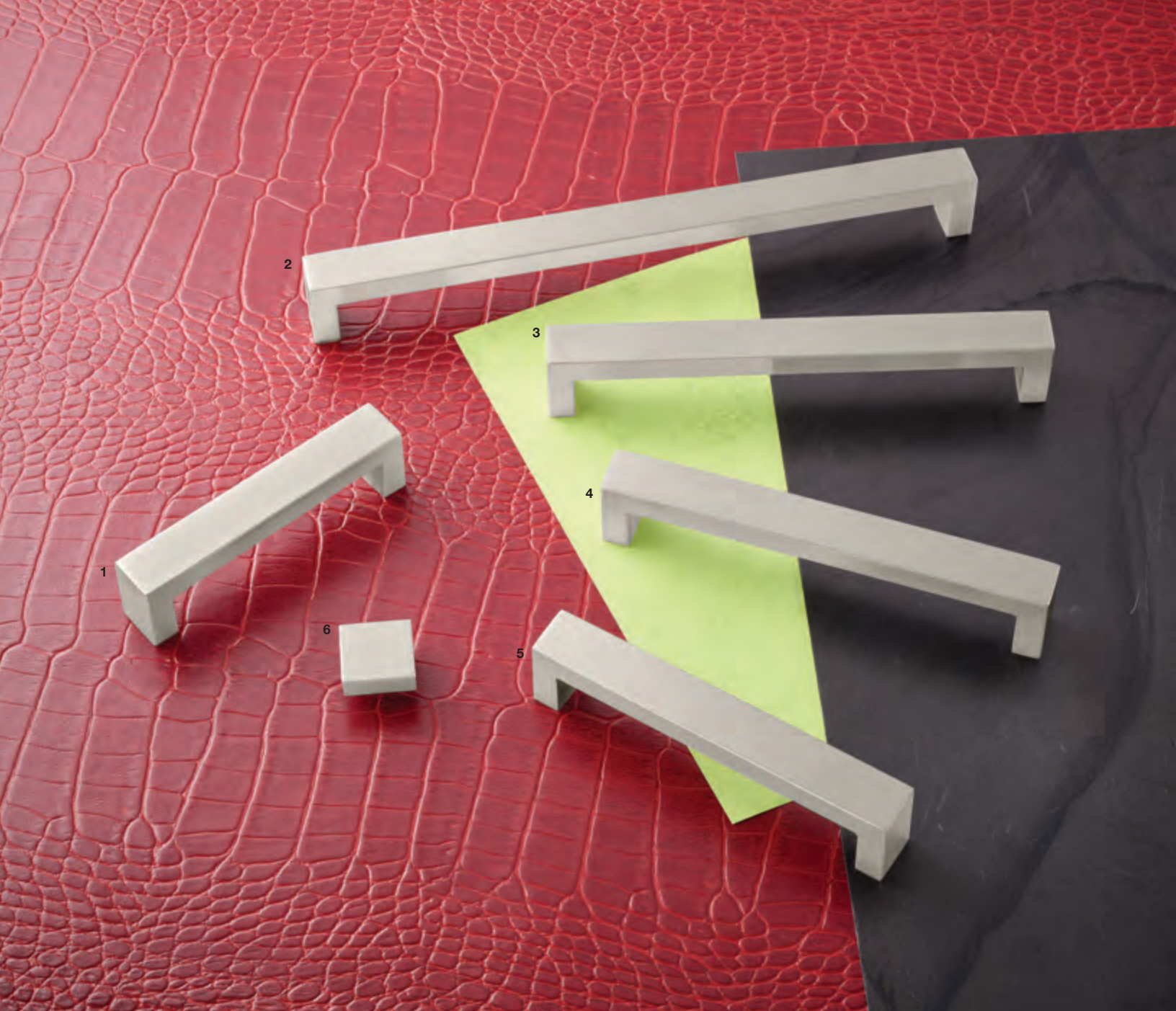

Futura



	Finish	Material	A	C	Item No.	SRP/pc.
1	matt	Stainless Steel 304	141	128	155.01.460	\$17.15
2	matt	Stainless Steel 304	333	320	155.01.465	\$42.66
3	matt	Stainless Steel 304	237	224	155.01.463	\$31.12
4	matt	Stainless Steel 304	205	192	155.01.462	\$27.36
5	matt	Stainless Steel 304	173	160	155.01.461	\$26.76
6	matt	Stainless Steel 304	-	-	155.01.517	\$15.10

1-5

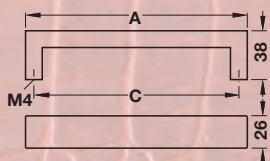

6

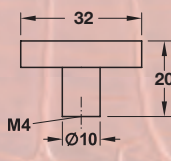



Contemporary



	Finish	Material	A	C	Item No.	SRP/pc.
1	oil-rubbed bronze	Steel	526	456	117.97.359	\$15.85
2	oil-rubbed bronze	Steel	376	306	117.97.358	\$10.93
3	oil-rubbed bronze	Steel	226	156	117.97.357	\$6.27
4	oil-rubbed bronze	Steel	168	128	117.97.352	\$5.63
5	oil-rubbed bronze	Steel	136	96	117.97.351	\$4.95

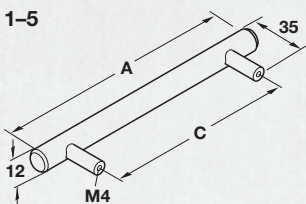

Dimensions in mm unless otherwise noted. Prices subject to change.



Contemporary



	Finish	Material	A	B	C	Item No.	SRP/pc.
1	matt nickel	Steel	138	-	128	155.00.952	\$7.12
2	matt nickel	Steel	106	-	96	155.00.951	\$6.22
3	polished chrome	Steel	112	30	96	155.00.820	\$5.63
4	polished chrome	Steel	148	30	128	155.00.821	\$6.79
5	polished chrome	Steel	184	32	160	155.00.822	\$8.08
6	polished chrome	Steel	221	32	192	155.00.823	\$8.97
7	dark oil-rubbed bronze	Steel	148	30	128	155.00.871	\$10.19
8	dark oil-rubbed bronze	Steel	112	30	96	155.00.870	\$6.56

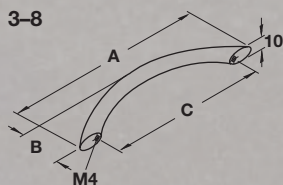
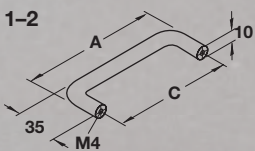



Contemporary



	Finish	Material	A	C	Item No.	SRP/pc.
1	matt	Stainless Steel	107	96	155.01.450	\$19.38
2	matt	Stainless Steel	144	128	155.01.451	\$31.98
3	matt	Stainless Steel	181	160	155.01.452	\$26.59
4	matt	Stainless Steel	218	192	155.01.453	\$30.14
5	matt	Stainless Steel	25	-	134.81.617	\$17.07
6	matt	Stainless Steel	32	-	134.81.626	\$21.92
7	stainless steel look	Zinc	-	-	110.22.001	\$28.12
8	polished chrome	Zinc	-	-	113.96.237	\$27.24

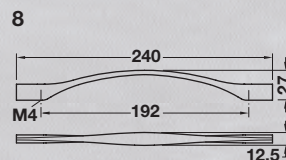
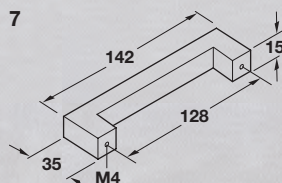
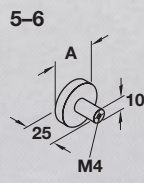
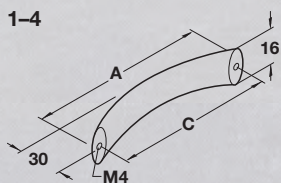

Dimensions in mm unless otherwise noted. Prices subject to change.



Contemporary



	Finish	Material	A	C	Item No.	SRP/pc.
1	polished chrome	Steel	376	306	155.00.811	\$10.49
2	polished chrome	Steel	526	456	155.00.813	\$13.73
3	polished chrome	Steel	828	758	155.00.816	\$18.06
4	polished chrome	Steel	226	156	155.00.810	\$6.37
5	polished chrome	Steel	168	128	155.00.361	\$4.90
6	polished chrome	Steel	136	96	155.00.360	\$4.81

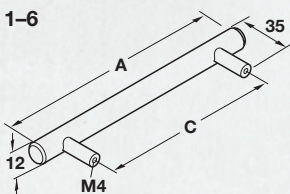



Contemporary



	Finish	Material	A	C	Item No.	SRP/pc.
1	matt nickel	Steel	298	288	155.00.956	\$16.26
2	matt nickel	Steel	202	192	155.00.954	\$11.16
3	matt nickel	Steel	170	160	155.00.953	\$9.33
4	polished chrome	Steel	138	128	155.00.932	\$5.41
5	polished chrome	Steel	106	96	155.00.931	\$4.81
6	satin chrome	Brass	110	4"	116.39.464	\$9.13
7	oil-rubbed bronze	Zinc	-	-	134.45.110	\$2.77
8	oil-rubbed bronze	Zinc	-	-	120.61.350	\$3.06
9	dark oil-rubbed bronze	Zinc	-	-	134.35.320	\$5.74

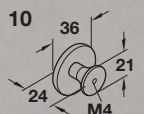
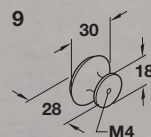
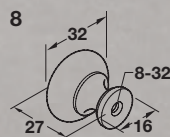
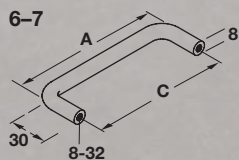
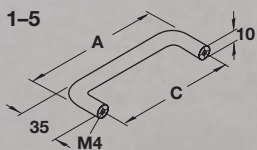



Contemporary



	Finish	Material	A	B	C	D	Item No.	SRP/pc.
1	brushed nickel	Aluminum	139	–	128	–	155.02.025	\$9.56
2	brushed nickel	Aluminum	171	–	160	–	155.02.030	\$10.49
3	matt black	Aluminum	139	–	128	–	155.02.027	\$9.49
4	matt black	Aluminum	171	–	160	–	155.02.032	\$10.53
5	matt black	Zinc	136	27	128	10	116.22.343	\$10.72
6	matt black	Zinc	104	25	96	9	116.22.334	\$9.51
7	matt nickel	Zinc	136	27	128	10	116.22.647	\$10.72
8	matt nickel	Zinc	104	25	96	9	116.22.638	\$9.51

1-4

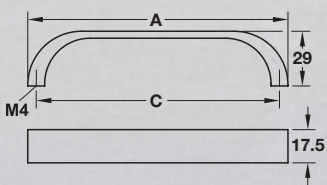

5-8

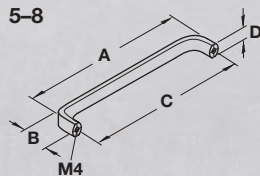



Contemporary



	Finish	Material	A	B	C	Item No.	SRP/pc.
1	matt nickel	Steel	332	31	288	155.00.845	\$16.02
2	matt nickel	Steel	392	41	352	155.00.846	\$19.54
3	matt nickel	Steel	221	32	192	155.00.843	\$11.08
4	matt nickel	Steel	184	32	160	155.00.842	\$9.78
5	matt nickel	Steel	148	30	128	155.00.841	\$7.85
6	matt nickel	Steel	112	30	96	155.00.840	\$7.04
7	satin chrome	Steel	135	-	5"	116.07.443	\$2.36
8	satin chrome	Steel	110	-	4"	116.07.427	\$1.88
9	satin chrome	Steel	97	-	3.5"	116.07.418	\$1.89

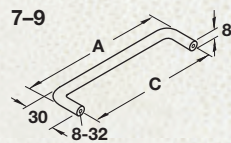
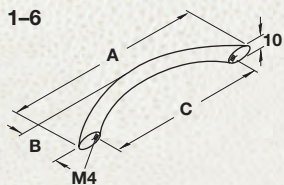

Note
Supplied with 1" mounting screws.



Contemporary



	Finish	Material	A	B	C	Item No.	SRP/pc.
1	stainless steel look	Zinc	81	29	64	155.00.490	\$2.02
2	stainless steel look	Zinc	112	24	96	155.00.491	\$2.98
3	stainless steel look	Zinc	155	30	128	155.00.492	\$4.95
4	stainless steel look	Zinc	203	30	160	155.00.493	\$6.89
5	stainless steel look	Zinc	286	33	224	155.00.494	\$12.19

1-5

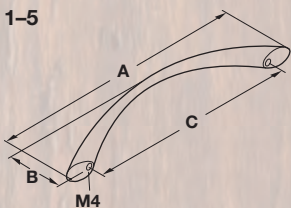



Contemporary



	Finish	Material	A	C	Item No.	SRP/pc.
1	matt chrome	Steel	104	96	116.07.423	\$2.03
2	matt chrome	Steel	110	4"	116.07.426	\$2.03
3	matt nickel	Steel	104	96	116.07.624	\$1.87
4	matt nickel	Steel	110	4"	116.07.627	\$1.95
5	polished chrome	Steel	-	-	155.00.891	\$1.58
6	brushed nickel	Steel - hollow	-	-	134.41.001	\$1.84
7	matt black	Plastic	-	-	136.75.300	\$1.31

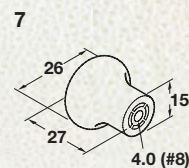
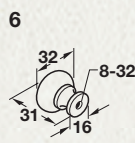
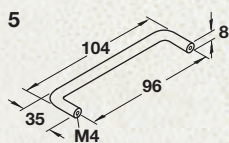
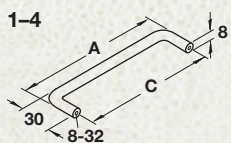

Note
Supplied with 1" mounting screws.



Contemporary



	Finish	Material	A	C	Item No.	SRP/pc.
1	polished chrome	Steel	110	4"	116.07.227	\$1.88
2	polished chrome	Steel	104	96	116.07.224	\$1.87
3	polished chrome	Steel	84	3"	116.07.217	\$1.73
4	satin bronzed copper	Steel	104	96	116.07.118	\$1.88
5	white	Nylon	-	-	116.71.100	\$0.78
6	satin chrome	Steel	104	96	116.07.424	\$2.03
7	satin chrome	Steel	84	3"	116.07.417	\$1.81
8	matt nickel	Steel	-	-	155.00.911	\$2.17
9	stainless steel look	Steel	-	-	155.00.921	\$1.70
10	matt chrome	Steel	-	-	155.00.901	\$1.64

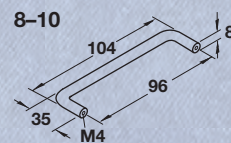
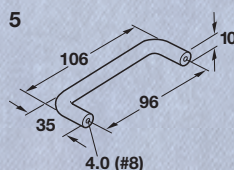
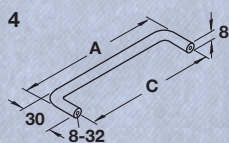
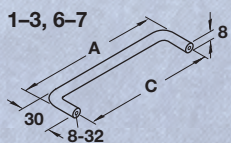

Note
Supplied with 1" mounting screws.



Contemporary

	Finish
1	stainless steel look
2	matt nickel
3	matt aluminum
4	matt black

	Material
1	Zinc
2	Steel
3	Aluminum
4	Plastic

	Item No.	SRP/pc.
1	103.84.632	\$21.72
2	116.07.631	\$12.99
3	117.67.955	\$22.00
4	138.69.353	\$9.83

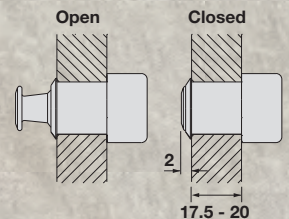
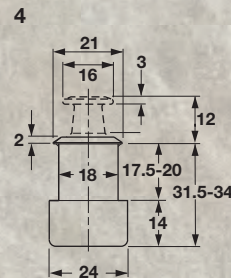
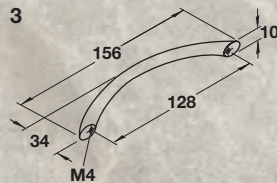
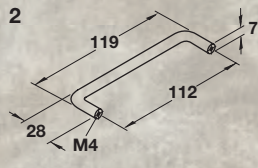
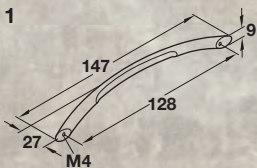



Westin

	Finish	Material	A	C	Item No.	SRP/pc.
1	stainless steel	Aluminum	136	96	112.83.000	\$28.72
2	matt aluminum	Aluminum	168	128	112.83.902	\$24.74
3	stainless steel	Aluminum	200	160	112.83.003	\$34.16
4	matt aluminum	Aluminum	232	192	112.83.904	\$30.86
5	stainless steel	Aluminum	300	260	112.83.006	\$44.08
6	matt aluminum	Aluminum	1000	960	112.83.911	\$88.28
7	stainless steel	Aluminum	500	460	112.83.010	\$59.14
8	matt aluminum	Aluminum	400	360	112.83.909	\$43.26

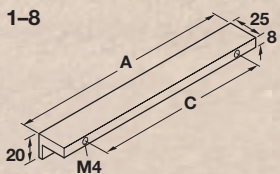



Westin

	Finish	Material	A	C	Item No.	SRP/pc.
1	matt aluminum	Aluminum	300	260	112.83.906	\$35.38
2	stainless steel	Aluminum	400	360	112.83.009	\$49.62
3	matt aluminum	Aluminum	500	460	112.83.910	\$47.12
4	stainless steel	Aluminum	1000	960	112.83.015	\$102.30
5	stainless steel	Aluminum	232	192	112.83.004	\$36.40
6	matt aluminum	Aluminum	200	160	112.83.903	\$27.68
7	stainless steel	Aluminum	168	128	112.83.002	\$31.18
8	matt aluminum	Aluminum	136	96	112.83.900	\$20.80

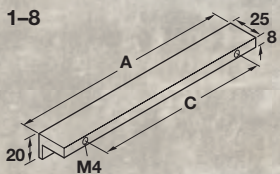

Dimensions in mm unless otherwise noted. Prices subject to change.



Contemporary

	Finish	Material	A	C	Item No.	SRP/pc.
1-2	matt	Stainless Steel	158	128	106.74.602	\$35.62
	matt	Stainless Steel	240	210	106.74.613	\$40.80
3	matt chrome	Steel & Zinc	168	128	117.26.400	\$45.06
4	matt chrome	Steel & Zinc	264	224	117.25.401	\$49.12
5	polished chrome	Zinc	-	-	109.50.205	\$36.34
6	stainless steel look	Zinc	-	-	155.00.591	\$4.13

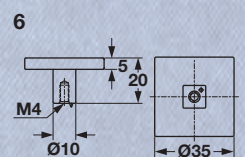
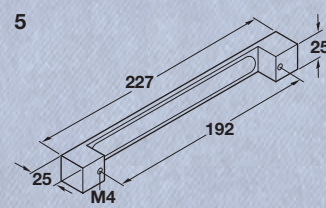
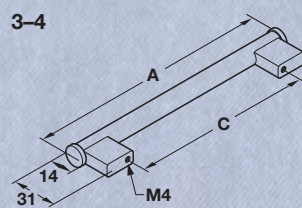
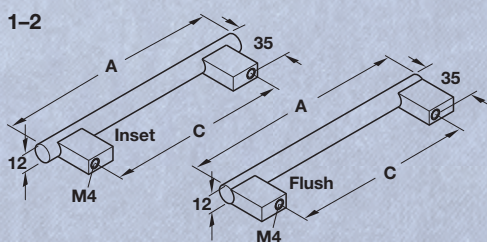



Contemporary

	Finish	Material	A	C	Item No.	SRP/pc.
1	black texture	Zinc	-	-	117.28.331	\$9.44
2	matt black	Steel	-	-	116.09.340	\$9.04
3	matt nickel, antimicrobial	Steel	-	-	116.07.664	\$10.61
4	matt aluminum	Aluminum	234	224	116.05.959	\$10.29
5	matt aluminum	Aluminum	138	128	116.05.931	\$6.59
6	matt aluminum	Aluminum	106	96	116.05.922	\$6.40
7	satin nickel	Zinc	-	-	102.36.600	\$14.14

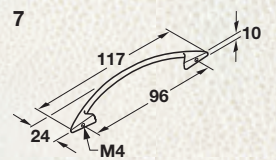
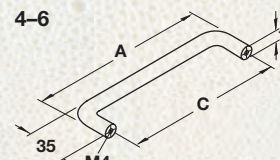
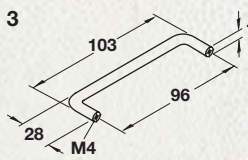
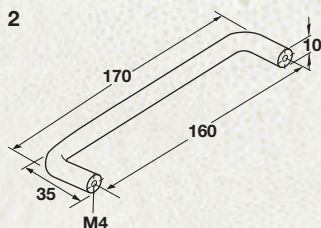
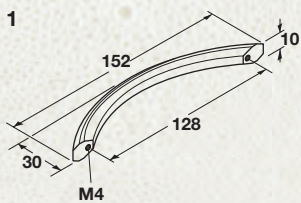

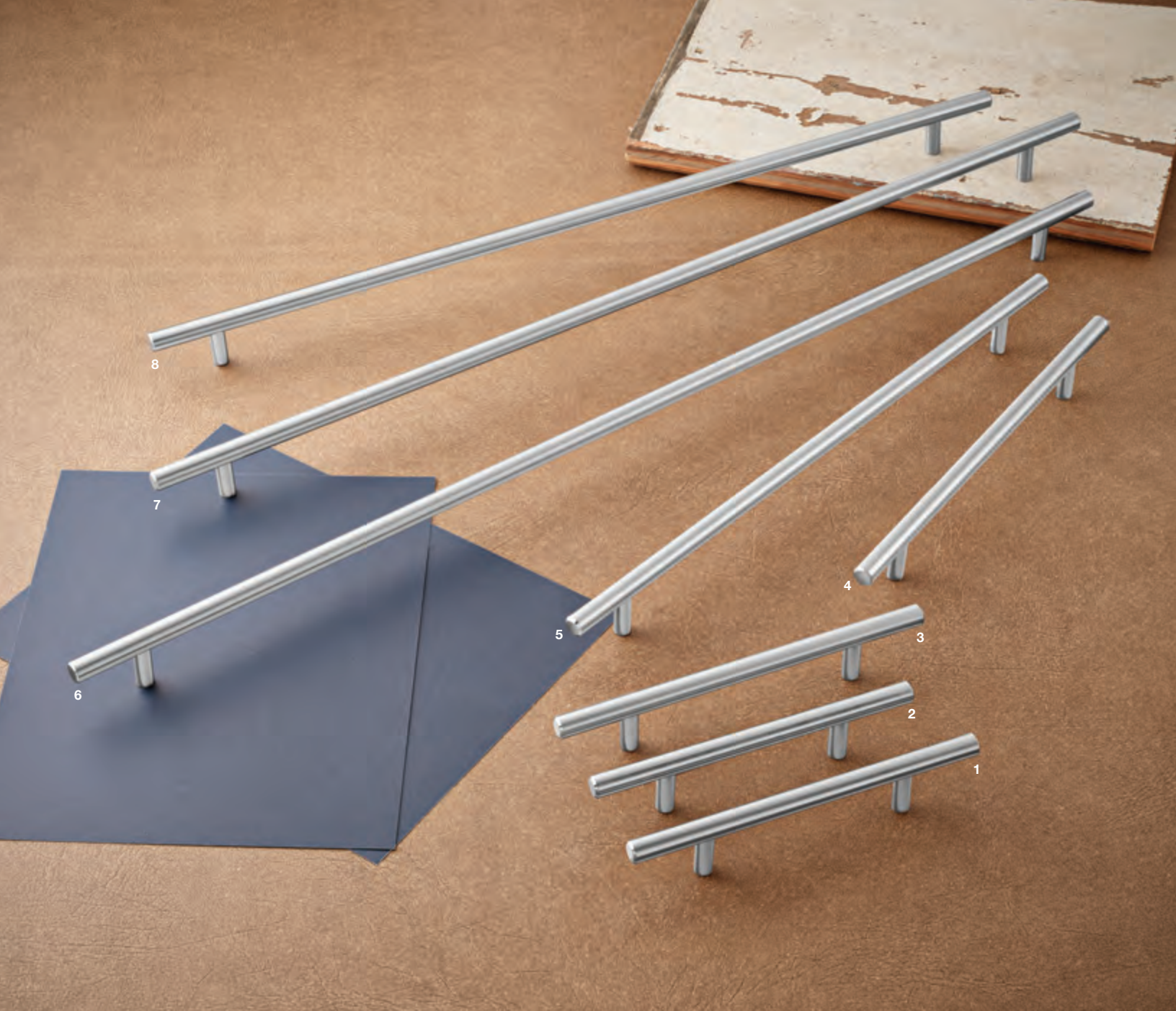

Contemporary

	Finish	Material	A	C	Item No.	SRP/pc.
1	stainless steel look	Steel	188	108	101.20.752	\$5.94
2	stainless steel look	Steel	176	96	101.20.751	\$4.98
3	stainless steel look	Steel	208	128	101.20.753	\$7.39
4	stainless steel look	Steel	272	192	101.20.754	\$7.66
5	stainless steel look	Steel	413	333	101.20.755	\$10.71
6	stainless steel look	Steel	718	638	101.20.758	\$21.06
7	stainless steel look	Steel	642	562	101.20.757	\$15.73
8	stainless steel look	Steel	566	486	101.20.756	\$16.29

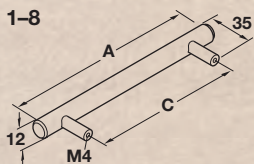



Contemporary

	Finish	Material	Item No.	SRP/pc.
1	matt nickel	Zinc	107.20.603	\$5.28
2	black matt	Zinc	107.20.303	\$6.48
3	polished chrome	Zinc	116.22.236	\$8.95
4	polished chrome	Brass	116.39.259	\$8.54
5	stainless steel	Zinc	117.14.620	\$5.88
6	satin chrome	Metal	134.43.401	\$5.15
7	stainless steel look	Metal	134.43.601	\$5.37
8	matt chrome	Metal	134.43.404	\$6.67
9	stainless steel	Brass - hollow	134.46.609	\$6.61

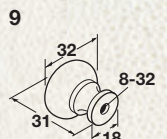
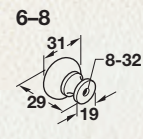
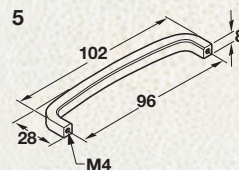
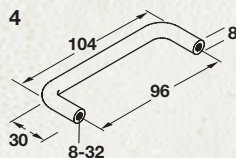
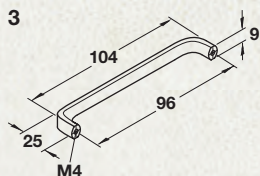
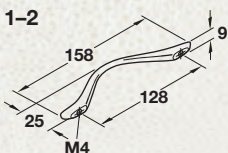

Dimensions in mm unless otherwise noted. Prices subject to change.



Contemporary

	Finish	Material	Item No.	SRP/pc.
1	satin	Brass	116.39.553	\$7.05
2	polished brass	Metal	134.43.801	\$6.13
3	black nickel	Steel	117.31.936	\$10.15
4	black nickel	Zinc	104.35.310	\$9.76
5	black nickel	Zinc	134.45.308	\$3.09

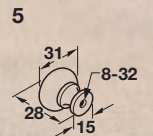
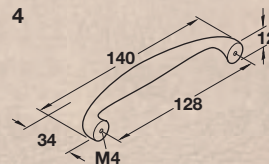
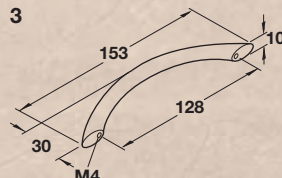
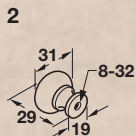
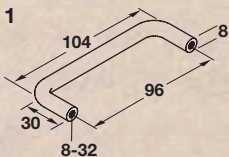

Note
Supplied with mounting screws.



Contemporary

	Finish	Material	A	C	Item No.	SRP/pc.
1	oil-rubbed bronze	Steel	-	-	116.09.324	\$4.16
2	dark oil-rubbed bronze	Steel	104	96	116.07.323	\$3.14
3	dark oil-rubbed bronze	Steel	110	4"	116.07.333	\$3.25
4	stainless steel look	Steel	84	3"	116.07.017	\$1.81
5	stainless steel look	Steel	97	3.5"	116.07.018	\$1.89
6	stainless steel look	Steel	104	96	116.07.024	\$2.54
7	stainless steel look	Steel	110	4"	116.07.027	\$2.54
8	stainless steel look	Steel	135	5"	116.07.043	\$2.31
9	polished chrome	Metal	-	-	134.43.201	\$5.35
10	dark oil-rubbed bronze	Metal	-	-	134.43.331	\$5.79

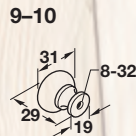
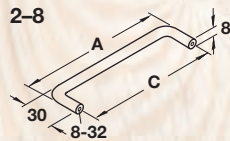
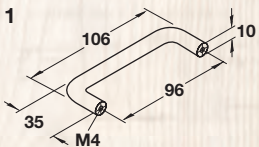

Note
Supplied with mounting screws.



Tempest **NEW**

	Finish	Material	A	C	Item No.	SRP/pc.
1	matt gold	Aluminum	-	-	110.52.440	\$17.28
2	matt black	Aluminum	-	-	110.52.441	\$17.28
3	dark bronze	Aluminum	-	-	110.52.442	\$17.28
4	matt gold	Aluminum	104	64	110.52.450	\$19.75
5	matt black	Aluminum	104	64	110.52.451	\$19.75
6	dark bronze	Aluminum	104	64	110.52.452	\$19.75
7	matt gold	Aluminum	168	128	110.52.460	\$22.22
8	matt black	Aluminum	168	128	110.52.461	\$22.22
9	dark bronze	Aluminum	168	128	110.52.462	\$22.22

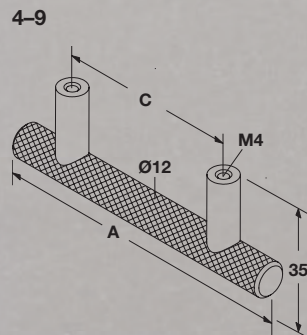
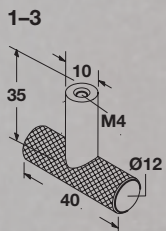



Tempest NEW

	Finish	Material	A	C	Item No.	SRP/pc.
1	matt gold	Aluminum	200	160	110.52.470	\$24.72
2	matt gold	Aluminum	296	256	110.52.480	\$37.06
3	dark bronze	Aluminum	200	160	110.52.472	\$24.72
4	dark bronze	Aluminum	296	256	110.52.482	\$37.06
5	matt black	Aluminum	200	160	110.52.471	\$24.72
6	matt black	Aluminum	296	256	110.52.481	\$37.06

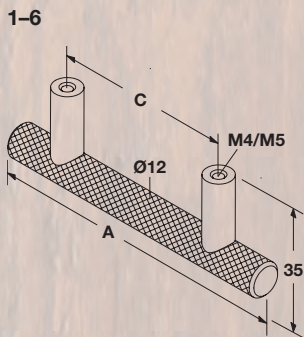

Dimensions in mm unless otherwise noted. Prices subject to change.



Bar Pulls

BY AMEROCK

	Finish	Material	A	C	Item No.	SRP/pc.
1	gold champagne	Steel	137	76 (3")	133.50.662	\$14.20
2	black bronzed	Steel	252	192	133.53.052	\$23.66
3	gold champagne	Steel	337	256	133.50.659	\$24.86
4	black bronzed	Steel	400	320	133.53.047	\$29.62
5	gold champagne	Steel	560	480	133.50.661	\$35.52
6	gold champagne	Steel	156	96	133.50.663	\$15.94
7	black bronzed	Steel	156	96	133.53.050	\$15.94
8	black bronzed	Steel	-	-	133.53.046	\$11.82

Note

Supplied with 1" mounting screws. Refer to page 269 for matching appliance pulls.

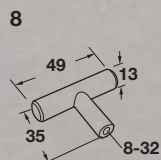
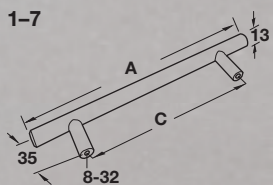



Bar Pulls

BY AMEROCK

	Finish	Material	A	C	Item No.	SRP/pc.
1	gold champagne	Steel	187	128	133.50.657	\$17.76
2	black bronzed	Steel	187	128	133.53.051	\$19.53
3	black bronzed	Steel	337	256	133.53.053	\$27.60
4	gold champagne	Steel	400	320	133.50.660	\$26.62
5	black bronzed	Steel	560	480	133.53.048	\$39.46
6	gold champagne	Steel	252	192	133.50.658	\$21.28
7	black bronzed	Steel	137	76 (3")	133.53.049	\$14.20
8	gold champagne	Steel	-	-	133.50.678	\$10.64

Note

Supplied with 1" mounting screws. Refer to page 269 for matching appliance pulls.

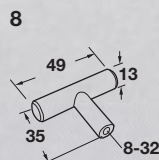
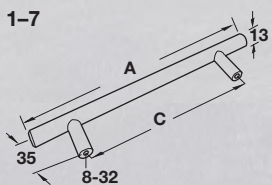



Bar Pulls

BY AMEROCK

	Finish	Material	A	C	Item No.	SRP/pc.
1	gunmetal	Steel	400	320	133.50.667	\$26.62
2	polished nickel	Steel	560	480	133.50.675	\$35.52
3	gunmetal	Steel	252	192	133.50.665	\$21.28
4	polished nickel	Steel	337	256	133.50.673	\$24.86
5	polished nickel	Steel	187	128	133.50.671	\$19.53
6	gunmetal	Steel	156	96	133.50.670	\$15.94
7	polished nickel	Steel	156	96	133.50.677	\$15.94
8	gunmetal	Steel	—	—	133.50.679	\$10.64

Note

Supplied with 1" mounting screws. Refer to page 269 for matching appliance pulls.

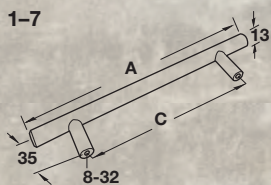



Bar Pulls

BY AMEROCK

	Finish	Material	A	C	Item No.	SRP/pc.
1	gunmetal	Steel	137	76 (3")	133.50.669	\$14.20
2	gunmetal	Steel	187	128	133.50.664	\$19.53
3	gunmetal	Steel	337	256	133.50.666	\$24.86
4	gunmetal	Steel	560	480	133.50.668	\$35.52
5	polished nickel	Steel	400	320	133.50.674	\$26.62
6	polished nickel	Steel	252	192	133.50.672	\$21.28
7	polished nickel	Steel	137	76 (3")	133.50.676	\$14.20
8	polished nickel	Steel	-	-	133.50.680	\$10.64

Note

Supplied with 1" mounting screws. Refer to page 269 for matching appliance pulls.

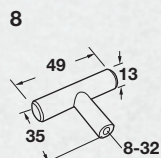
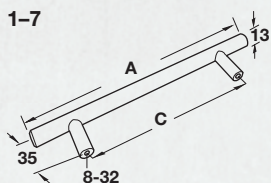



Riva

BY AMEROCK

ADA 3-4

	Finish	Material	A	C	Item No.	SRP/pc.
1	satin nickel	Zinc	92	76 (3")	133.53.019	\$12.32
2	satin nickel	Zinc	113	96	133.50.711	\$14.08
3	satin nickel	Zinc	144	128	133.53.020	\$15.84
4	satin nickel	Zinc	178	160	133.53.021	\$17.59

Note
Supplied with mounting screws.

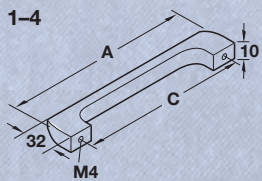



Rift **NEW**

BY AMEROCK

ADA

	Finish	Material	A	C	Item No.	SRP/pc.
1	satin nickel	Zinc	108	96	133.53.513	\$10.57
2	satin nickel	Zinc	140	128	133.53.514	\$14.06
3	polished chrome	Zinc	108	96	133.53.455	\$10.57
4	polished chrome	Zinc	140	128	133.53.456	\$14.06
5	matt black	Zinc	108	96	133.53.402	\$10.57
6	matt black	Zinc	140	128	133.53.403	\$14.06

Note
Supplied with mounting screws.

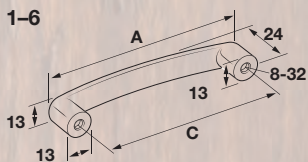

Dimensions in mm unless otherwise noted. Prices subject to change.



Caliber NEW

BY AMEROCK

	Finish	Material	Item No.	SRP/pc.
1	polished chrome	Zinc	133.53.440	\$17.59
2	satin nickel	Zinc	133.53.494	\$15.85
3	champagne bronze	Zinc	133.53.323	\$15.85
4	matt black	Zinc	133.53.383	\$15.85
5	champagne bronze	Zinc	133.53.328	\$42.29
6	satin nickel	Zinc	133.53.499	\$42.29
7	polished chrome	Zinc	133.53.445	\$42.29
8	matt black	Zinc	133.53.388	\$42.29

Note
Supplied with mounting screws.

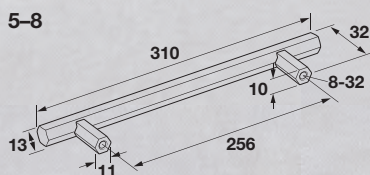
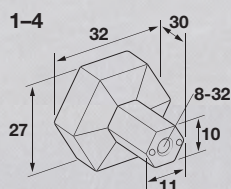



Caliber NEW

BY AMEROCK

	Finish	Material	A	C	Item No.	SRP/pc.
1	polished chrome	Zinc	149	96	133.53.441	\$21.11
2	polished chrome	Zinc	181	128	133.53.442	\$28.18
3	polished chrome	Zinc	214	160	133.53.443	\$31.73
4	polished chrome	Zinc	246	192	133.53.444	\$35.21
5	champagne bronze	Zinc	149	96	133.53.324	\$17.28
6	champagne bronze	Zinc	181	128	133.53.325	\$25.34
7	champagne bronze	Zinc	214	160	133.53.326	\$28.56
8	champagne bronze	Zinc	246	192	133.53.327	\$35.21

Note
Supplied with mounting screws.

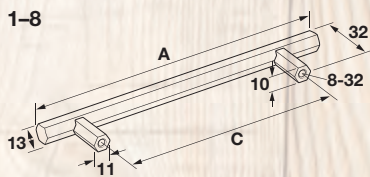

Dimensions in mm unless otherwise noted. Prices subject to change.



Caliber NEW

BY AMEROCK

	Finish	Material	A	C	Item No.	SRP/pc.
1	matt black	Zinc	149	96	133.53.384	\$18.99
2	matt black	Zinc	181	128	133.53.385	\$25.34
3	matt black	Zinc	214	160	133.53.386	\$28.56
4	matt black	Zinc	246	192	133.53.387	\$35.21
5	satin nickel	Zinc	149	96	133.53.495	\$18.99
6	satin nickel	Zinc	181	128	133.53.496	\$25.34
7	satin nickel	Zinc	214	160	133.53.497	\$28.56
8	satin nickel	Zinc	246	192	133.53.498	\$35.21

Note
Supplied with mounting screws.

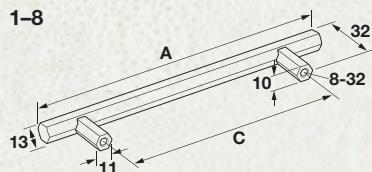



Radius **NEW**

BY AMEROCK

	Finish	Material	A	C	Item No.	SRP/pc.
1	champagne bronze	Stainless Steel	146	96	133.53.318	\$18.99
2	champagne bronze	Stainless Steel	179	128	133.53.319	\$25.34
3	champagne bronze	Stainless Steel	211	160	133.53.320	\$28.56
4	champagne bronze	Stainless Steel	243	192	133.53.321	\$35.21
5	satin nickel	Stainless Steel	146	96	133.53.489	\$18.99
6	satin nickel	Stainless Steel	179	128	133.53.490	\$25.34
7	satin nickel	Stainless Steel	211	160	133.53.491	\$28.56
8	satin nickel	Stainless Steel	243	192	133.53.492	\$35.21

Note
Supplied with mounting screws.

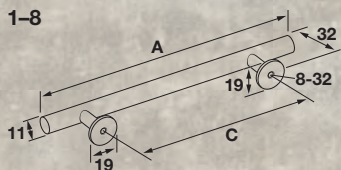

Dimensions in mm unless otherwise noted. Prices subject to change.

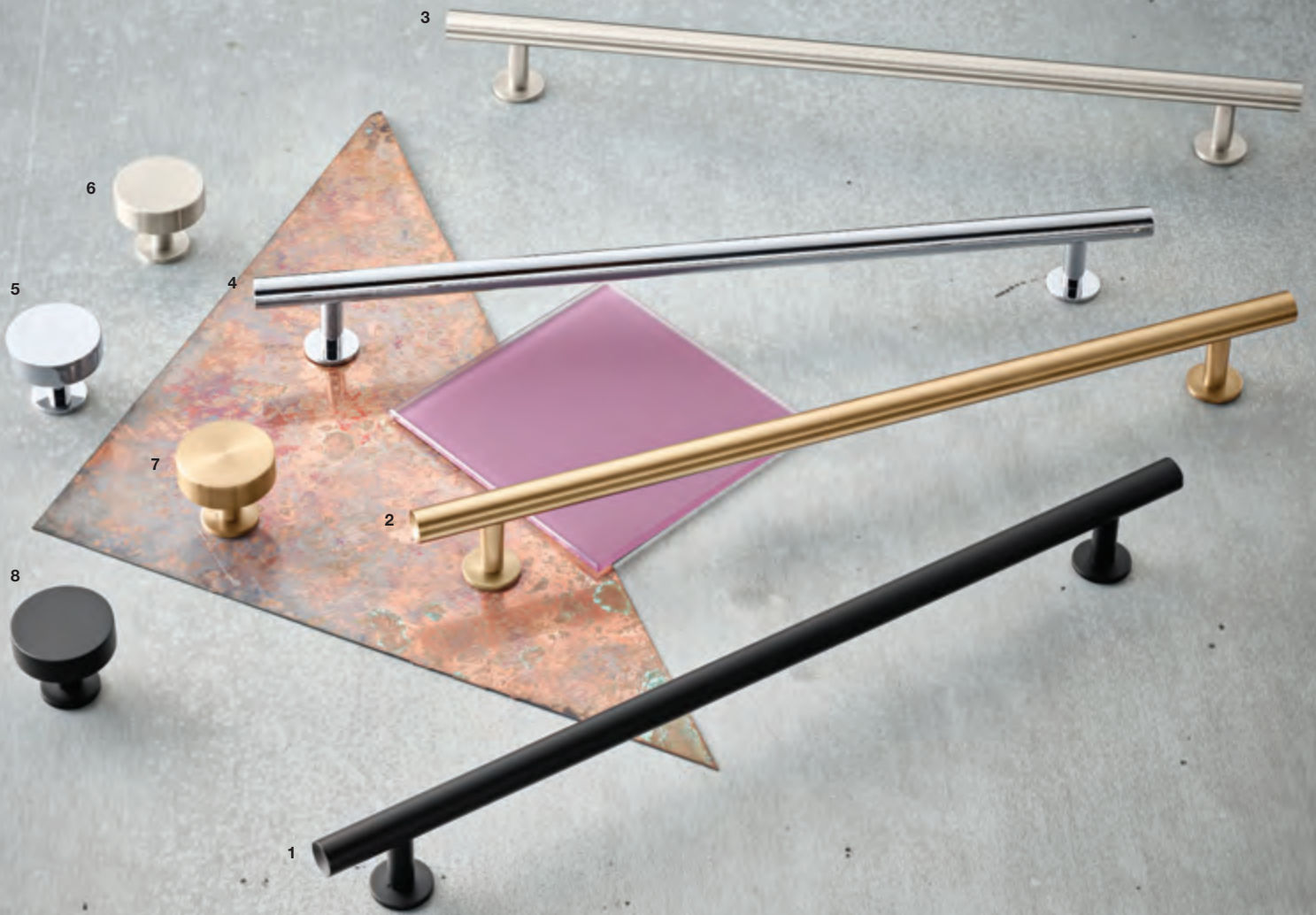

Radius **NEW**

BY AMEROCK

	Finish	Material	Item No.	SRP/pc.
1	matt black	Stainless Steel	133.53.382	\$42.29
2	champagne bronze	Stainless Steel	133.53.322	\$42.29
3	satin nickel	Stainless Steel	133.53.493	\$42.29
4	polished chrome	Stainless Steel	133.53.439	\$42.29
5	polished chrome	Stainless Steel	133.53.434	\$17.59
6	satin nickel	Stainless Steel	133.53.488	\$15.85
7	champagne bronze	Stainless Steel	133.53.317	\$15.85
8	matt black	Stainless Steel	133.53.377	\$15.85

Note
Supplied with mounting screws.

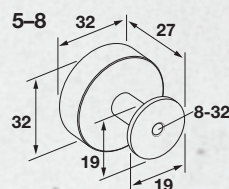
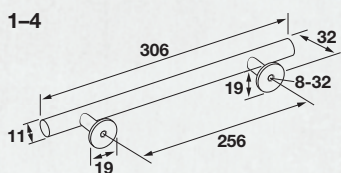



Radius **NEW**

BY AMEROCK

	Finish	Material	A	C	Item No.	SRP/pc.
1	polished chrome	Stainless Steel	146	96	133.53.435	\$21.11
2	polished chrome	Stainless Steel	179	128	133.53.436	\$28.18
3	polished chrome	Stainless Steel	211	160	133.53.437	\$31.73
4	polished chrome	Stainless Steel	243	192	133.53.438	\$35.21
5	matt black	Stainless Steel	146	96	133.53.378	\$18.99
6	matt black	Stainless Steel	179	128	133.53.379	\$25.34
7	matt black	Stainless Steel	211	160	133.53.380	\$25.94
8	matt black	Stainless Steel	243	192	133.53.381	\$35.21

Note
Supplied with mounting screws.

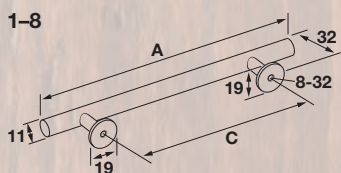



Destine NEW

BY AMEROCK

	Finish	Material	A	C	Item No.	SRP/pc.
1	champagne bronze	Zinc	-	-	133.53.312	\$15.85
2	champagne bronze	Zinc	125	96	133.53.313	\$18.99
3	champagne bronze	Zinc	157	128	133.53.314	\$25.34
4	champagne bronze	Zinc	189	160	133.53.315	\$28.56
5	champagne bronze	Zinc	252	224	133.53.316	\$35.21
6	matt black	Zinc	-	-	133.53.372	\$15.85
7	matt black	Zinc	125	96	133.53.373	\$18.99
8	matt black	Zinc	157	128	133.53.374	\$23.01
9	matt black	Zinc	189	160	133.53.375	\$28.56
10	matt black	Zinc	252	224	133.53.376	\$35.21

Note
Supplied with mounting screws.

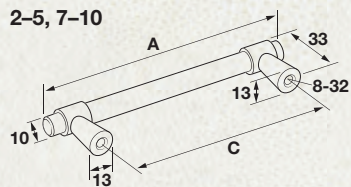
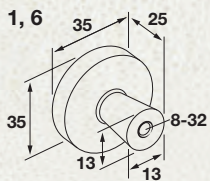

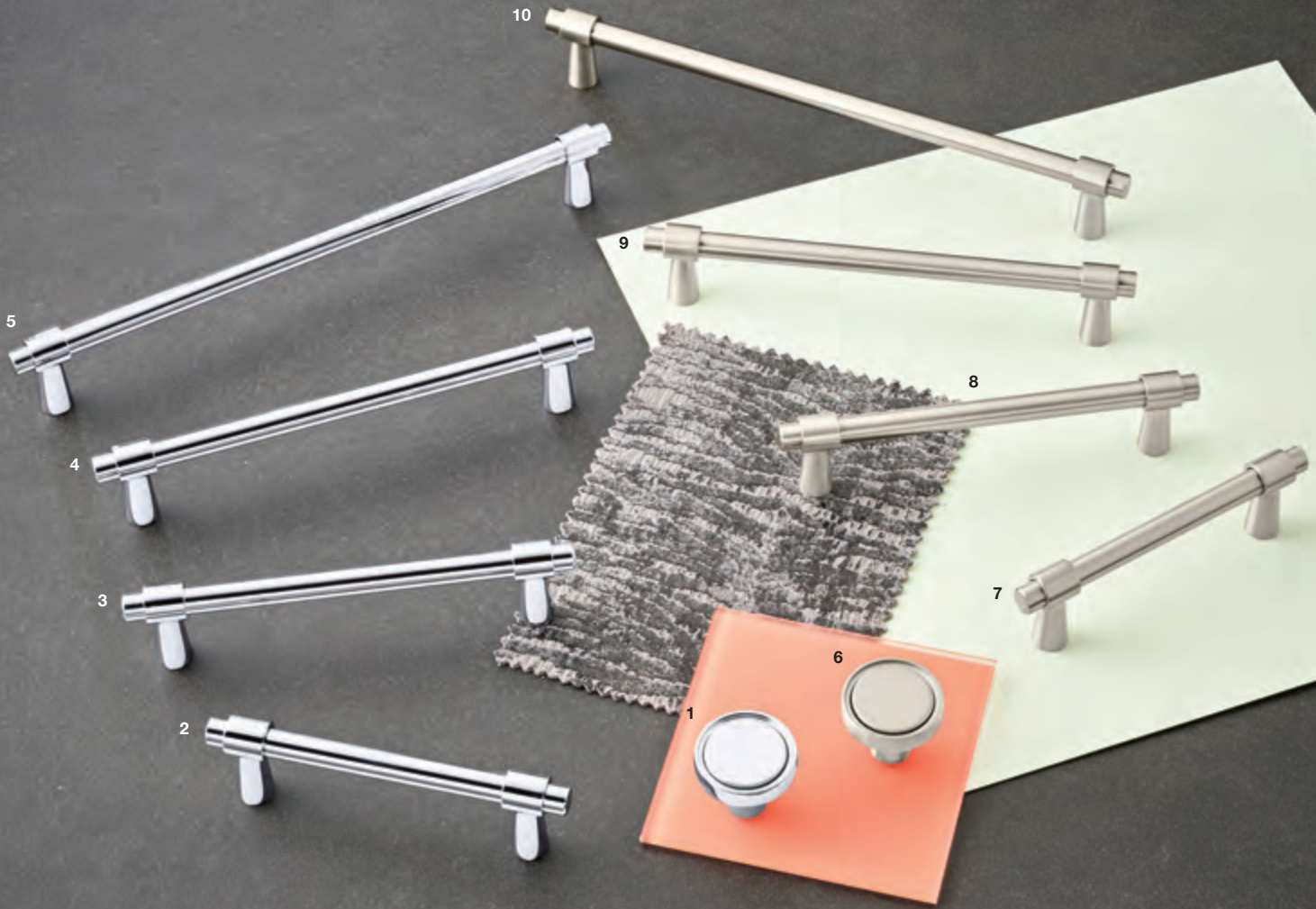

Destine NEW

BY AMEROCK

	Finish	Material	A	C	Item No.	SRP/pc.
1	polished chrome	Zinc	-	-	133.53.429	\$17.59
2	polished chrome	Zinc	125	96	133.53.430	\$21.11
3	polished chrome	Zinc	157	128	133.53.431	\$28.18
4	polished chrome	Zinc	189	160	133.53.432	\$31.73
5	polished chrome	Zinc	252	224	133.53.433	\$35.21
6	satin nickel	Zinc	-	-	133.53.483	\$15.85
7	satin nickel	Zinc	125	96	133.53.484	\$18.99
8	satin nickel	Zinc	157	128	133.53.485	\$25.34
9	satin nickel	Zinc	189	160	133.53.486	\$28.56
10	satin nickel	Zinc	252	224	133.53.487	\$35.21

Note
Supplied with mounting screws.

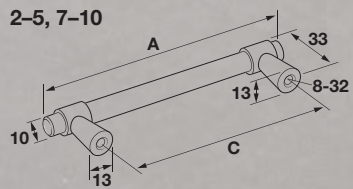
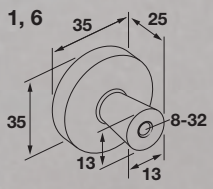

Dimensions in mm unless otherwise noted. Prices subject to change.



Mergence NEW

BY AMEROCK

	Finish	Material	A	C	Item No.	SRP/pc.
1	matt black/polished chrome	Zinc	125	96	133.53.466	\$24.67
2	matt black/polished chrome	Zinc	157	128	133.53.462	\$31.73
3	matt/black/polished chrome	Zinc	189	160	133.53.463	\$35.21
4	matt black/polished chrome	Zinc	252	224	133.53.464	\$38.73
5	matt black/polished chrome	Zinc	-	-	133.53.465	\$21.11
6	matt black/champagne bronze	Zinc	-	-	133.53.351	\$21.11
7	matt black/satin nickel	Zinc	-	-	133.53.409	\$21.11

Note
Supplied with mounting screws.

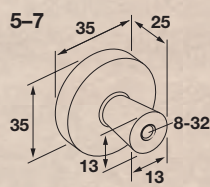
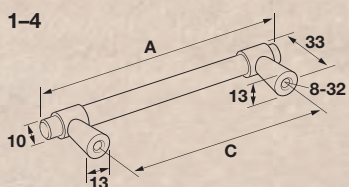

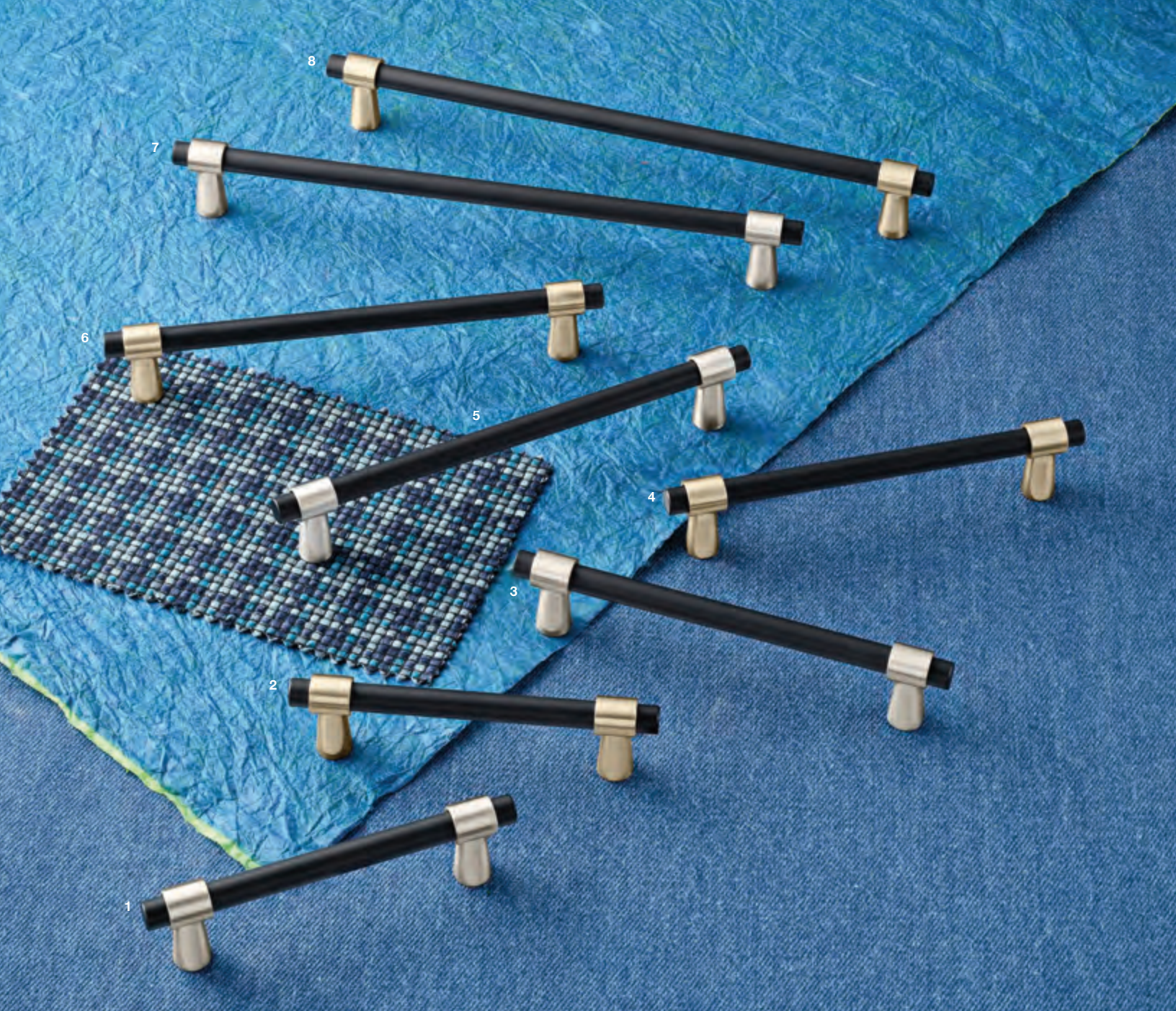

Mergence **NEW**

BY AMEROCK

	Finish	Material	A	C	Item No.	SRP/pc.
1	matt black/satin nickel	Zinc	125	96	133.53.352	\$24.67
2	matt black/champagne bronze	Zinc	125	96	133.53.347	\$24.67
3	matt/black/satin nickel	Zinc	157	128	133.53.353	\$31.73
4	matt black/champagne bronze	Zinc	157	128	133.53.348	\$31.73
5	matt black/satin nickel	Zinc	189	160	133.53.354	\$35.21
6	matt black/champagne bronze	Zinc	189	160	133.53.349	\$35.21
7	matt black/satin nickel	Zinc	252	224	133.53.410	\$38.78
8	matt black/champagne bronze	Zinc	252	224	133.53.350	\$38.78

Note
Supplied with mounting screws.

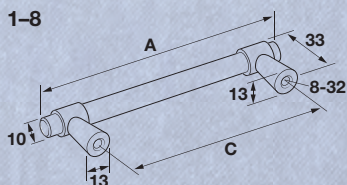

Dimensions in mm unless otherwise noted. Prices subject to change.



Premise NEW

BY AMEROCK

ADA 2-4, 6-8

	Finish	Material	A	C	Item No.	SRP/pc.
1	champagne bronze	Zinc	-	-	133.53.308	\$12.32
2	champagne bronze	Zinc	108	96	133.53.309	\$15.84
3	champagne bronze	Zinc	141	128	133.53.310	\$22.89
4	champagne bronze	Zinc	173	160	133.53.311	\$26.42
5	satin nickel	Zinc	-	-	133.53.479	\$12.32
6	satin nickel	Zinc	108	96	133.53.480	\$15.84
7	satin nickel	Zinc	141	128	133.53.481	\$22.89
8	satin nickel	Zinc	173	160	133.53.482	\$26.42

Note
Supplied with mounting screws.

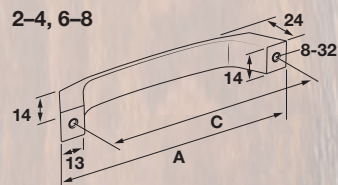
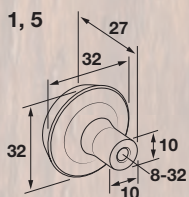



Premise NEW

BY AMEROCK

ADA 2-4, 6-8

	Finish	Material	A	C	Item No.	SRP/pc.
1	polished chrome	Zinc	-	-	133.53.425	\$12.32
2	polished chrome	Zinc	108	96	133.53.426	\$15.84
3	polished chrome	Zinc	141	128	133.53.427	\$22.89
4	polished chrome	Zinc	173	160	133.53.428	\$26.42
5	matt black	Zinc	-	-	133.53.368	\$12.32
6	matt black	Zinc	108	96	133.53.369	\$15.84
7	matt black	Zinc	141	128	133.53.370	\$22.89
8	matt black	Zinc	173	160	133.53.371	\$26.42

Note
Supplied with mounting screws.

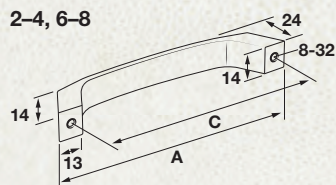
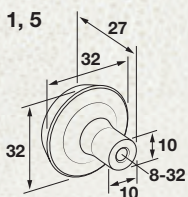

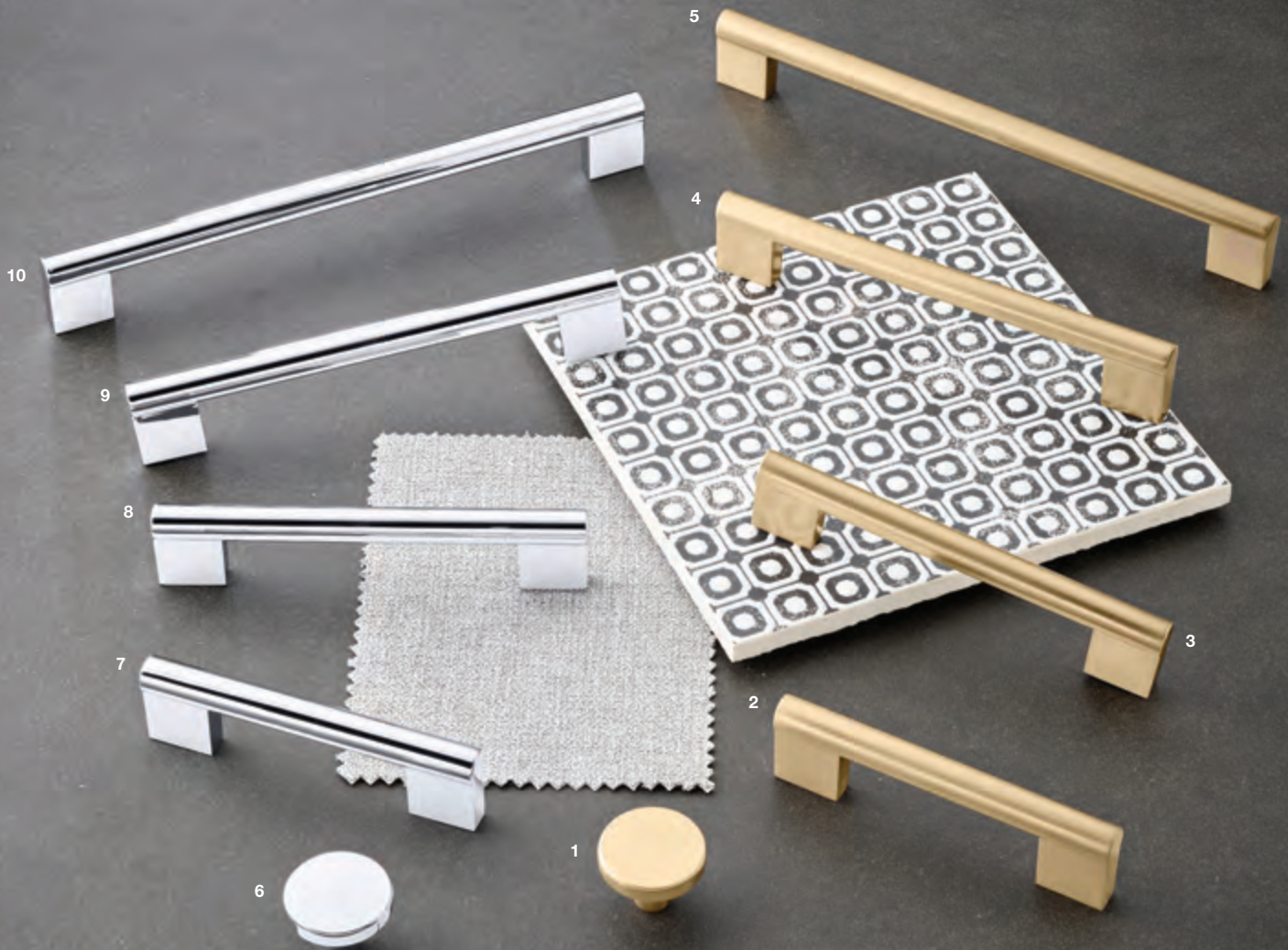

Versa NEW

BY AMEROCK

ADA 2-5, 7-10

	Finish	Material	A	C	Item No.	SRP/pc.
1	champagne bronze	Zinc	-	-	133.53.342	\$7.19
2	champagne bronze	Zinc	119	96	133.53.343	\$9.50
3	champagne bronze	Zinc	151	128	133.53.344	\$12.66
4	champagne bronze	Zinc	183	160	133.53.345	\$15.85
5	champagne bronze	Zinc	248	224	133.53.346	\$24.67
6	polished chrome	Zinc	-	-	133.53.457	\$8.80
7	polished chrome	Zinc	119	96	133.53.458	\$10.57
8	polished chrome	Zinc	151	128	133.53.459	\$14.06
9	polished chrome	Zinc	183	160	133.53.460	\$17.59
10	polished chrome	Zinc	248	224	133.53.461	\$24.67

Note
Supplied with mounting screws.

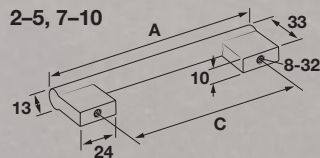
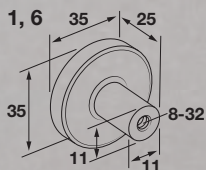



Versa NEW

BY AMEROCK

ADA 2-5, 7-10

	Finish	Material	A	C	Item No.	SRP/pc.
1	satin nickel	Zinc	-	-	133.53.515	\$7.92
2	satin nickel	Zinc	119	96	133.53.516	\$9.50
3	satin nickel	Zinc	151	128	133.53.517	\$12.66
4	satin nickel	Zinc	183	160	133.53.518	\$15.85
5	satin nickel	Zinc	248	224	133.53.519	\$24.67
6	matt black	Zinc	-	-	133.53.404	\$7.92
7	matt black	Zinc	119	96	133.53.405	\$9.50
8	matt black	Zinc	151	128	133.53.406	\$12.66
9	matt black	Zinc	183	160	133.53.407	\$15.85
10	matt black	Zinc	248	224	133.53.408	\$24.67

Note
Supplied with mounting screws.

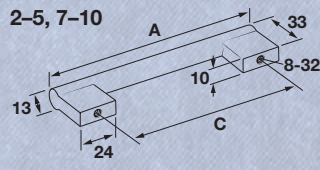
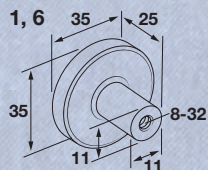

Dimensions in mm unless otherwise noted. Prices subject to change.

MINIMALIST

Oasis. Free from the distractions of clutter and busy ornament, minimalist design reveals a room's true character. Materials stress a natural simple state in wood, glass, stone, bamboo, woven grasses or wool. Deco should melt into the background, or is so candid and uncomplicated, it adds to the minimal statement. Integrated profiles that match the drawer and matt finishes complement the look.





Spartan



	Finish	Material	A	C	D	Item No.	SRP/pc.
1	silver colored	Zinc	90	64	83	155.01.931	\$5.51
2	polished chrome	Zinc	90	64	83	155.01.930	\$5.19
3	matt black	Zinc	90	64	83	155.01.932	\$4.58
4	matt black	Zinc	177	96	170	155.01.942	\$6.00
5	polished chrome	Zinc	177	96	170	155.01.940	\$6.72
6	silver colored	Zinc	177	96	170	155.01.941	\$7.03

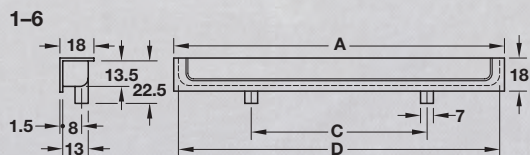



Impressions

	Finish	Material	Item No.	SRP/pc.
1	stainless steel look	Aluminum	151.85.030	\$95.68
2	stainless steel look	Zinc	151.85.089	\$14.94
3	matt aluminum	Aluminum	151.85.930	\$50.56
4	matt aluminum	Zinc	151.85.989	\$11.93
5	stainless steel look	Aluminum	151.86.030	\$117.12
6	stainless steel look	Zinc	151.86.089	\$14.94
7	matt aluminum	Aluminum	151.86.930	\$62.16
8	matt aluminum	Zinc	151.86.989	\$11.84

Note

Use 151.86.089 with 151.86.030; Use 151.85.089 with 151.85.030; Use 151.86.989 with 151.86.930; Use 151.85.989 with 151.85.930; Handles can be cut to size

1, 3

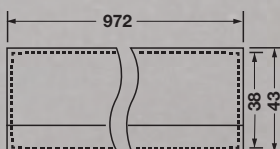

2, 4

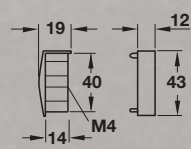

5, 7

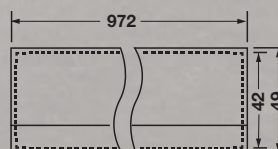

6, 8

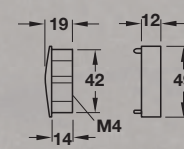



Venice

	Finish	Material	Item No.	SRP/pc.
1	black	Aluminum	126.63.003	\$133.12
2	matt nickel	Aluminum	126.63.001	\$133.12
3	black	Aluminum	126.63.011	\$196.44
4	matt nickel	Aluminum	126.63.009	\$178.58
5	black	Aluminum	126.63.015	\$171.14
6	matt nickel	Aluminum	126.63.013	\$171.14
7	matt nickel	Aluminum	126.63.005	\$107.78
8	black	Aluminum	126.63.007	\$107.78

Note

1-2, 7-8: Horizontal; 3-6: Vertical. Profile Length: 2895 mm

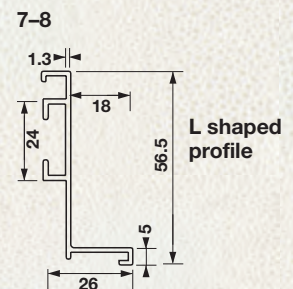
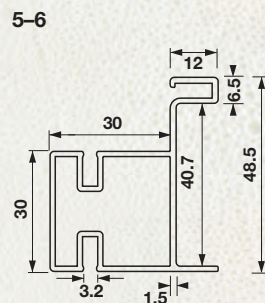
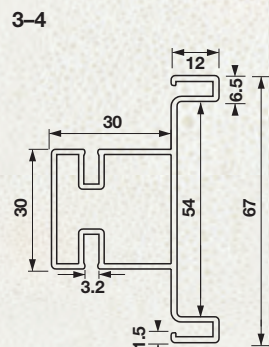
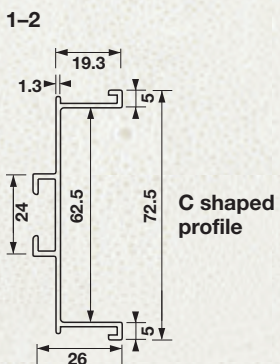

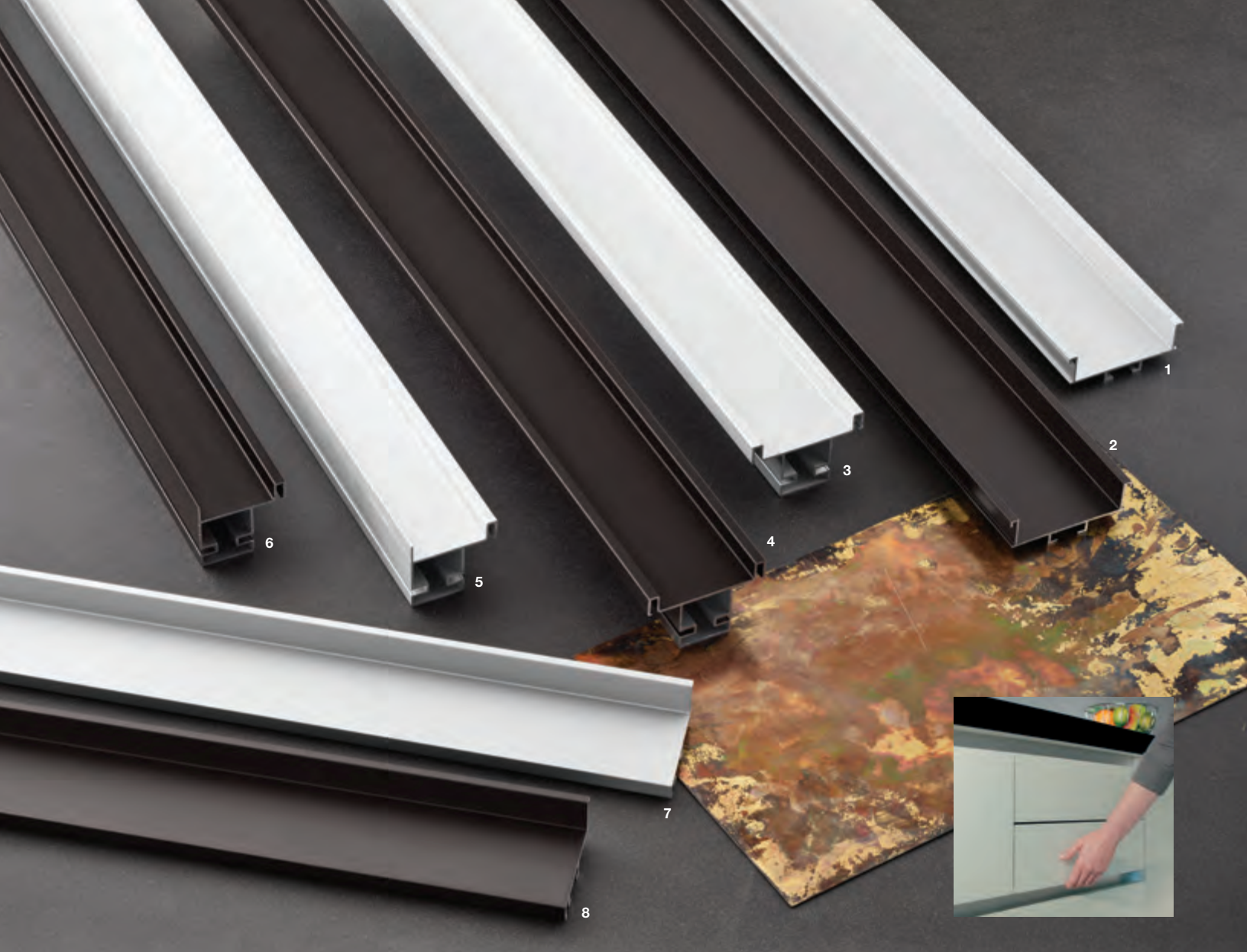

Venice

	Finish	Material	Item No.	SRP/pc.
1	matt aluminum	Aluminum	126.63.000	\$114.10
2	dark bronze	Aluminum	126.63.002	\$133.12
3	matt aluminum	Aluminum	126.63.008	\$171.14
4	dark bronze	Aluminum	126.63.010	\$196.44
5	matt aluminum	Aluminum	126.63.012	\$152.14
6	dark bronze	Aluminum	126.63.014	\$171.14
7	matt aluminum	Aluminum	126.63.004	\$95.10
8	dark bronze	Aluminum	126.63.006	\$107.78

Note

1-2, 7-8: Horizontal; 3-6: Vertical. Profile Length: 2895 mm

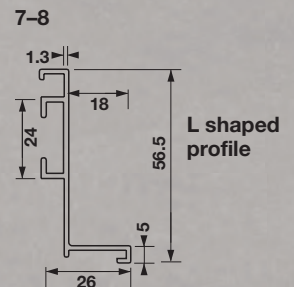
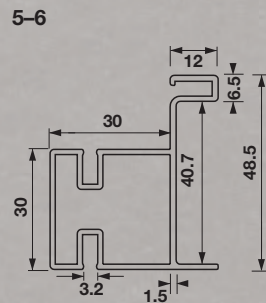
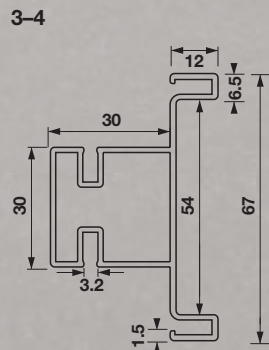
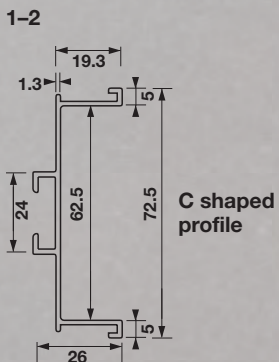



Venice Accessories

	3	4	5	6	SRP/pc.
Material	Plastic	Plastic	Plastic	Plastic	
Finish	Outer Corner	Outer Corner	Inner Corner	Inner Corner	
*matt aluminum	126.63.052	126.63.048	126.63.044	126.63.040	\$3.81
matt nickel	126.63.053	126.63.049	126.63.045	126.63.041	\$3.81
black	126.63.055	126.63.051	126.63.047	126.63.043	\$3.81
dark bronze	126.63.054	126.63.050	126.63.046	126.63.042	\$3.81

	7	8	9	11	12	13	SRP/pc.
Material	Plastic	Plastic	Plastic	Plastic	Plastic	Plastic	
Finish	L-cap, left	L-cap, right	C-cap, right or left	L-Cap, left	L-cap, right	C-cap, left or right	
*matt aluminum	126.63.024	126.63.028	126.63.032	126.63.016	126.63.020	126.63.036	\$2.54
matt nickel	126.63.025	126.63.029	126.63.033	126.63.017	126.63.021	126.63.037	\$2.54
black	126.63.027	126.63.031	126.63.035	126.63.019	126.63.023	126.63.039	\$2.54
dark bronze	126.63.026	126.63.030	126.63.034	126.63.018	126.63.022	126.63.038	\$2.54

Note

*Shown in matt aluminum. 3, 5, 7, 8, 11, 12 used with L shaped horizontal profiles and 4, 6, 9, 13 used with C shaped horizontal profiles on pages 163–164.

1. Straight Bracket

Finish	Material	Item No.	SRP/pc.
gray	Plastic	126.63.056	\$2.54

2. Connector, 90°

Finish	Material	Item No.	SRP/pc.
gray	Plastic	126.63.058	\$2.54

10. Bracket

Finish	Material	Item No.	SRP/pc.
gray	Plastic	126.63.057	\$2.54



Passages

	Finish	Material	Length	Working Length	Item No.	SRP/pc.
1	stainless steel look	Aluminum	2500	2460	126.53.003	\$58.40
2	matt aluminum	Aluminum	2500	2460	126.53.902	\$109.00
3	black RAL 9005	Aluminum	2500	2460	126.53.303	\$104.48
4	white RAL 9010	Aluminum	2500	2460	126.53.702	\$79.46

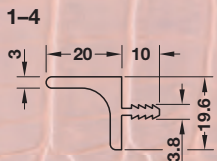

Dimensions in mm unless otherwise noted. Prices subject to change.

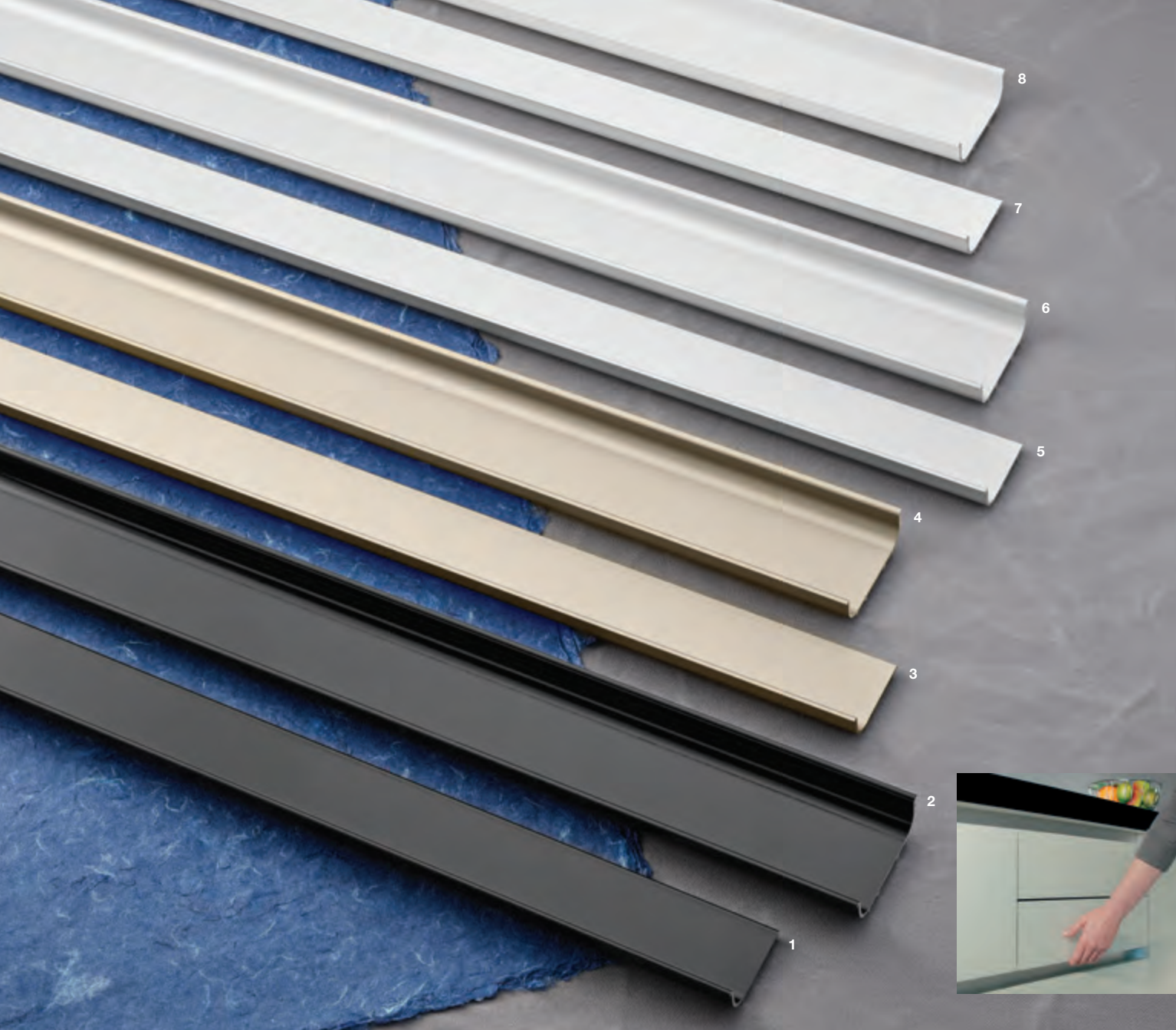

Passages

	Finish	Material	Length	Working Length	Item No.	SRP/pc.
1	black	Aluminum	2500	2460	126.37.300	\$126.06
2	black	Aluminum	2500	2460	126.36.300	\$160.52
3	stainless steel	Aluminum	2500	2460	126.37.001	\$62.20
4	stainless steel	Aluminum	2500	2460	126.36.001	\$85.82
5	matt	Aluminum	2500	2460	126.37.900	\$92.12
6	matt	Aluminum	2500	2460	126.36.900	\$125.36
7	white	Aluminum	2500	2460	126.37.700	\$82.40
8	white	Aluminum	2500	2460	126.36.700	\$117.66

Note

Refer to page 170 for required accessories.

1, 3, 5, 7

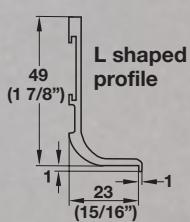

2, 4, 6, 8

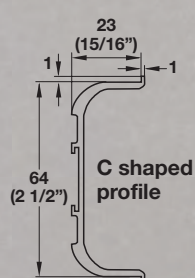

Installation

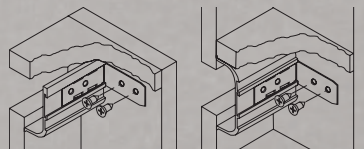



Passages

	Finish	Material	Length	Working Length	Item No.	SRP/pc.
1	stainless steel look	Aluminum	2500	2460	126.37.123	\$67.58
2	white RAL 9010	Aluminum	2500	2460	126.37.722	\$90.38
3	stainless steel look	Aluminum	2500	2460	126.37.113	\$95.34
4	white RAL 9010	Aluminum	2500	2460	126.37.712	\$127.92

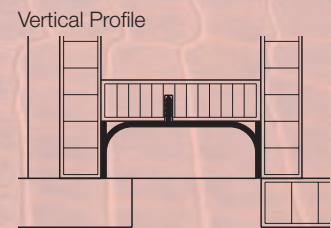
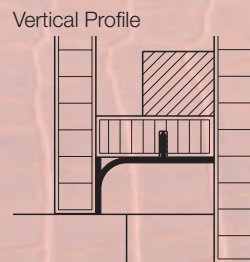
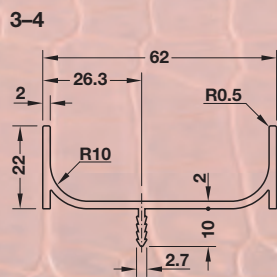
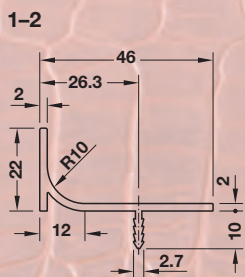

Dimensions in mm unless otherwise noted. Prices subject to change.



Passages

	Finish	Material	Length	Working Length	Item No.	SRP/pc.
1	matt aluminum	Aluminum	2500	2460	126.37.922	\$116.34
2	black RAL 9005	Aluminum	2500	2460	126.37.322	\$156.02
3	matt aluminum	Aluminum	2500	2460	126.37.912	\$178.40
4	black RAL 9005	Aluminum	2500	2460	126.37.312	\$223.94

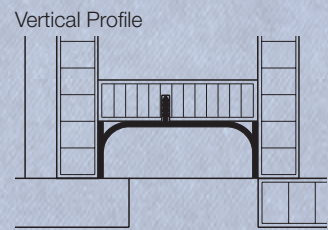
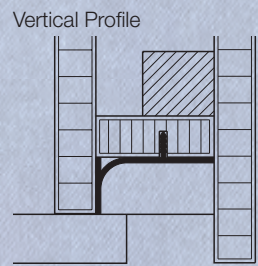
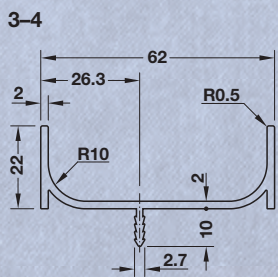
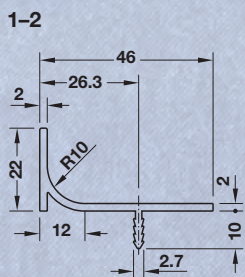

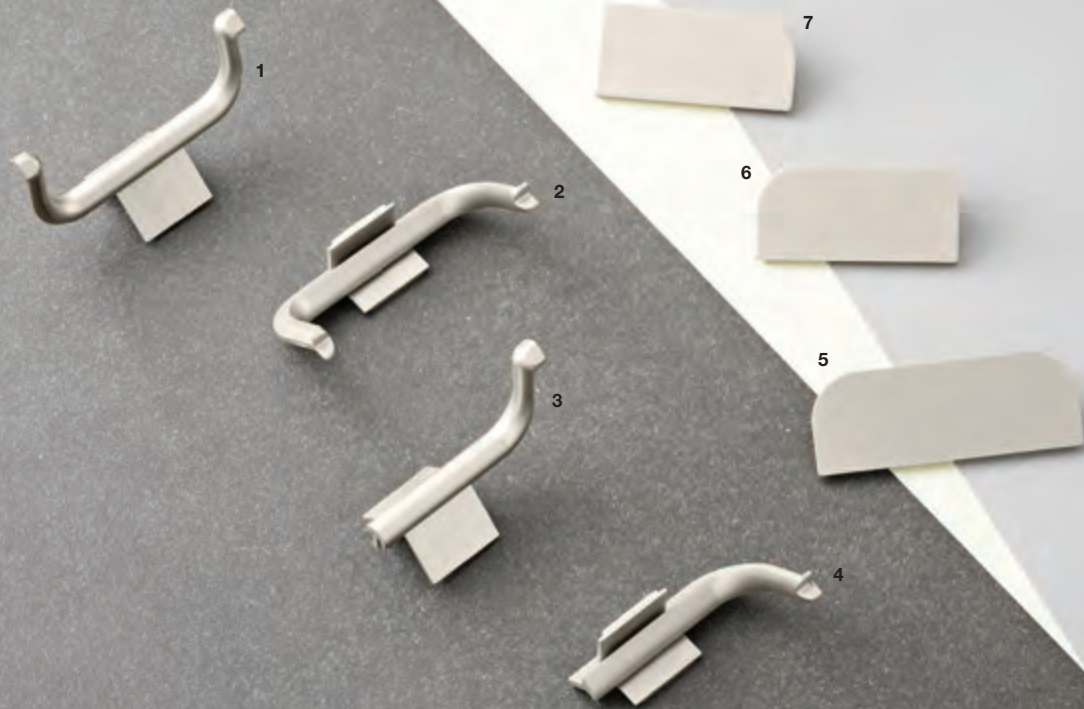

Passages Accessories

	1	2	SRP/pc.	3	4	SRP/pc.
Material	Plastic	Plastic		Plastic	Plastic	
Finish	Outside Corner	Inside Corner		Outside Corner	Inside Corner	
silver anodized*	126.37.986	126.37.981	\$3.44	126.37.985	126.37.980	\$6.04
stainless steel look	126.37.071	126.37.070	\$3.44	126.37.075	126.37.074	\$6.04
black	126.37.371	126.37.370	\$3.44	126.37.375	126.37.374	\$6.04
white	126.37.771	126.37.770	\$3.44	126.37.775	126.37.774	\$6.04

	5	SRP/pc.	6	SRP/pc.	7	SRP/pc.
Material	Plastic		Plastic		Plastic	
Finish	End Cap, right and left		End Cap, left		End Cap, right	
silver anodized*	126.37.996	\$2.40	126.37.998	\$2.40	126.37.997	\$2.40
stainless steel look	126.37.096	\$2.40	126.37.098	\$2.40	126.37.097	\$2.40
black	126.37.936	\$2.40	126.37.938	\$2.40	126.37.937	\$2.40
white	126.37.976	\$2.40	126.37.978	\$2.40	126.37.977	\$2.40

Note

*Shown in silver anodized. 1, 2, 5 used with C shaped profiles 2, 4, 6, 8 and 3, 4, 6, 7 used with L shaped profiles 1, 3, 5, 7 on page 167.



Mounting Bracket 90°

Material	Item No.	SRP/pc.
Stainless Steel	126.37.990	\$3.01



Minimalist NEW*

	Finish	Material	Length	Item No.	SRP/pc.
1*	stainless steel	Aluminum	2500	155.01.632	\$118.50
2	matt aluminum	Aluminum	3000	126.19.900	\$132.68
3	matt aluminum	Aluminum	-	106.11.904	\$18.45

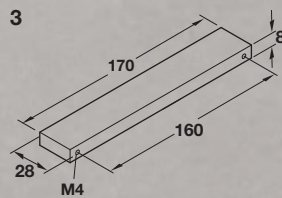
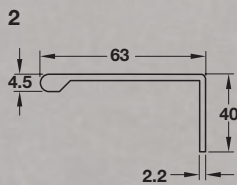
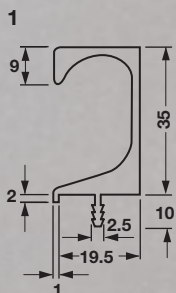



Minimalist

	Finish	Material	Length	Item No.	SRP/pc.
1	matt aluminum	Aluminum	2500	126.38.925	\$74.54
2	satin aluminum	Aluminum	2500	126.40.900	\$28.34
3	matt aluminum	Aluminum	2500	126.35.925	\$104.96

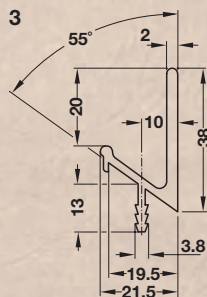
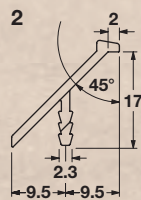
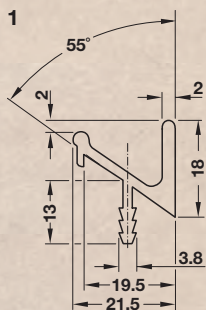

Dimensions in mm unless otherwise noted. Prices subject to change.

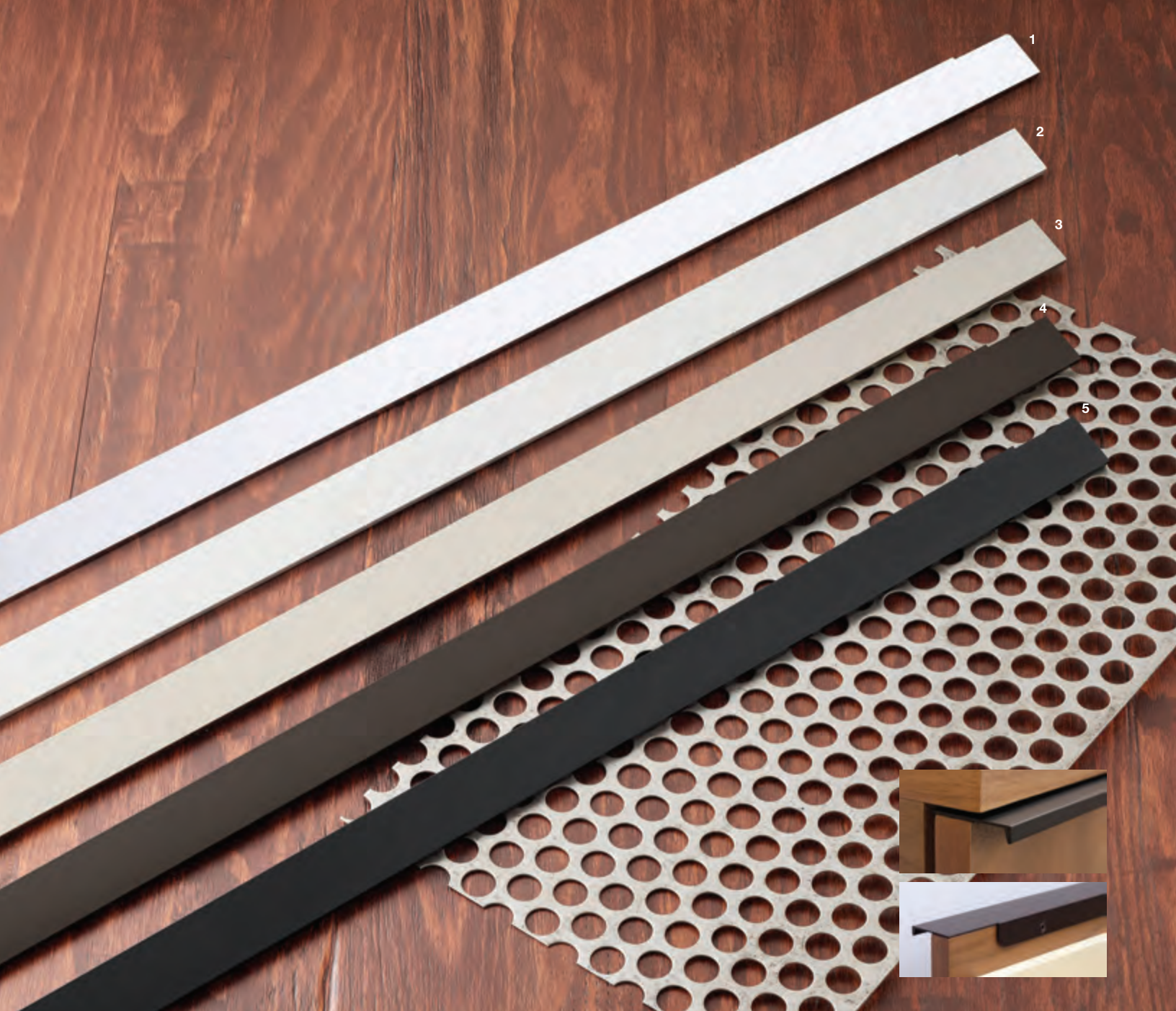

Oslo **NEW**

	Finish	Material	A	C	Item No.	SRP/pc.
1	polished chrome	Aluminum	910	768	106.04.134	\$66.67
2	aluminum anodized	Aluminum	910	768	106.04.130	\$61.75
3	matt nickel	Aluminum	910	768	106.04.131	\$64.22
4	dark bronze	Aluminum	910	768	106.04.132	\$64.22
5	matt black	Aluminum	910	768	106.04.133	\$64.22

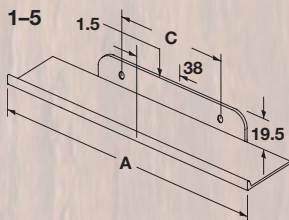



Oslo NEW

- | | Finish |
|---|-------------------|
| 1 | polished chrome |
| 2 | matt nickel |
| 3 | aluminum anodized |
| 4 | matt black |
| 5 | dark bronze |

Material	A	C	Item No.	SRP/pc.
Aluminum	757	576	106.04.124	\$54.34
Aluminum	757	576	106.04.121	\$51.89
Aluminum	757	576	106.04.120	\$49.39
Aluminum	757	576	106.04.123	\$51.89
Aluminum	757	576	106.04.122	\$51.89

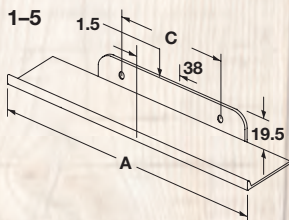

Dimensions in mm unless otherwise noted. Prices subject to change.



Oslo **NEW**

	Finish	Material	A	C	Item No.	SRP/pc.
1	dark bronze	Aluminum	605	448	106.04.112	\$46.92
2	aluminum anodized	Aluminum	605	448	106.04.110	\$44.47
3	matt nickel	Aluminum	605	448	106.04.111	\$46.92
4	polished chrome	Aluminum	605	448	106.04.114	\$49.39
5	matt black	Aluminum	605	448	106.04.113	\$46.92

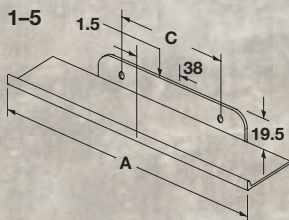

1



2



3



4



5



Oslo **NEW**

	Finish	Material	A	C	Item No.	SRP/pc.
1	polished chrome	Aluminum	529	384	106.04.104	\$39.53
2	dark bronze	Aluminum	529	384	106.04.102	\$37.06
3	matt nickel	Aluminum	529	384	106.04.101	\$37.06
4	aluminum anodized	Aluminum	529	384	106.04.100	\$35.83
5	matt black	Aluminum	529	384	106.04.103	\$37.06

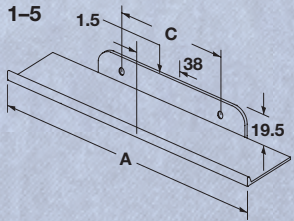

Dimensions in mm unless otherwise noted. Prices subject to change.



Oslo NEW

	Finish	Material	A	C	Item No.	SRP/pc.
1	polished chrome	Aluminum	452	320	106.04.094	\$33.36
2	aluminum anodized	Aluminum	452	320	106.04.090	\$30.89
3	matt nickel	Aluminum	452	320	106.04.091	\$32.14
4	dark bronze	Aluminum	452	320	106.04.092	\$32.14
5	matt black	Aluminum	452	320	106.04.093	\$32.14

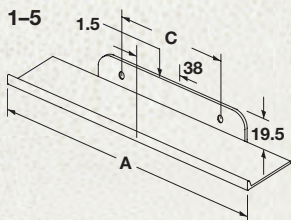



Oslo **NEW**

	Finish	Material	A	C	Item No.	SRP/pc.
1	polished chrome	Aluminum	376	256	106.04.084	\$25.97
2	matt nickel	Aluminum	376	256	106.04.081	\$24.72
3	aluminum anodized	Aluminum	376	256	106.04.080	\$23.45
4	dark bronze	Aluminum	376	256	106.04.082	\$24.72
5	matt black	Aluminum	376	256	106.04.083	\$24.72

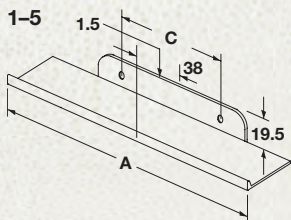

Dimensions in mm unless otherwise noted. Prices subject to change.



Oslo **NEW**

	Finish	Material	A	C	Item No.	SRP/pc.
1	polished chrome	Aluminum	224	96	106.04.064	\$16.05
2	aluminum anodized	Aluminum	224	96	106.04.060	\$13.58
3	matt nickel	Aluminum	224	96	106.04.061	\$14.81
4	dark bronze	Aluminum	224	96	106.04.062	\$14.81
5	matt black	Aluminum	224	96	106.04.063	\$14.81
6	polished chrome	Aluminum	300	160	106.04.074	\$20.99
7	aluminum anodized	Aluminum	300	160	106.04.070	\$18.52
8	matt nickel	Aluminum	300	160	106.04.071	\$19.75
9	dark bronze	Aluminum	300	160	106.04.072	\$19.75
10	matt black	Aluminum	300	160	106.04.073	\$19.75

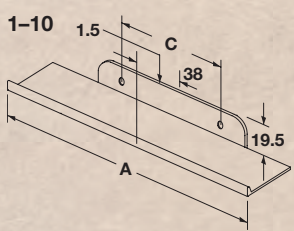



Providence NEW

	Finish	Material	A	C	Item No.	SRP/pc.
1	polished chrome	Aluminum	212	192	106.04.011	\$24.72
2	aluminum anodized	Aluminum	212	192	106.04.010	\$23.45
3	matt gold	Aluminum	212	192	106.04.012	\$25.97
4	matt black	Aluminum	212	192	106.04.013	\$24.72
5	polished chrome	Aluminum	84	64	106.04.001	\$13.58
6	aluminum anodized	Aluminum	84	64	106.04.000	\$12.35
7	matt gold	Aluminum	84	64	106.04.002	\$14.81
8	matt black	Aluminum	84	64	106.04.003	\$13.58

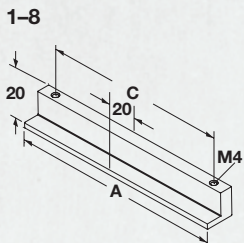

Dimensions in mm unless otherwise noted. Prices subject to change.

ARCHITECTURAL

Formidable. Structural vigor meets cutting-edge engineering. Then add clear sightlines to legends and trending influencers. Architectural deco styles can be commercial grade, often having special properties such as antimicrobial coatings or ADA-friendly knobs and pulls. Materials include corrosion resistant 304 grade stainless steel.







Architectural

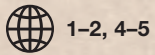

	Finish	Material	A	B	Item No.	SRP/pc.
1	matt aluminum	Zinc	-	-	155.00.230	\$39.66
2	matt nickel	Zinc	-	-	155.00.240	\$45.38
3	polished nickel/matt chrome	Steel	-	-	153.20.715	\$5.23
4	brushed nickel	Zinc	39	35	155.00.010	\$3.81
5	brushed nickel	Zinc	50	45	155.00.011	\$4.64

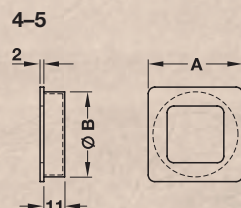
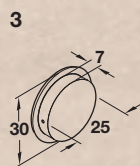
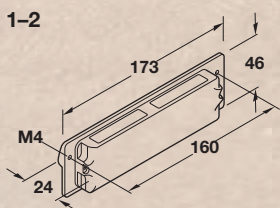



Atelier* and Architectural



	Finish	Material	Item No.	SRP/pc.
*1	brushed brass	Zinc	155.01.950	\$5.36
*2	brushed nickel	Zinc	155.01.951	\$5.36
*3	brushed nickel	Zinc	155.01.961	\$12.85
*4	brushed brass	Zinc	155.01.960	\$12.85
5	brushed brass	Zinc	155.01.794	\$8.89

1-2

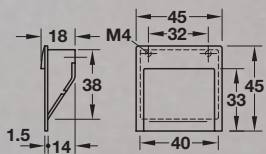

3-4

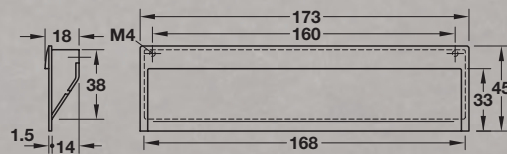

5

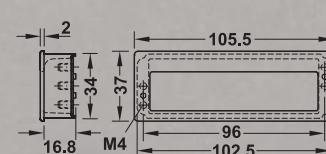



Architectural



Finish	Material	Item No.	SRP/pc.
1 black	Plastic	129.57.603	\$4.68
2 white	Plastic	129.57.701	\$3.72
3 black	Plastic	158.23.300	\$2.06
4 natural	Beech	192.29.300	\$11.38
5 natural	Red Oak	192.48.456	\$4.53
6 matt, antimicrobial	Stainless Steel	110.52.435	\$29.96
7 polished nickel/matt chrome	Steel	152.00.727	\$6.90
8 polished chrome	Zinc	155.00.275	\$8.42
9 matt chrome	Zinc	155.00.270	\$7.50

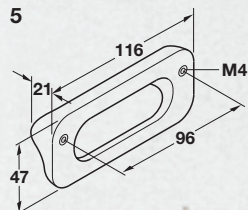
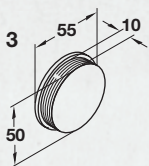
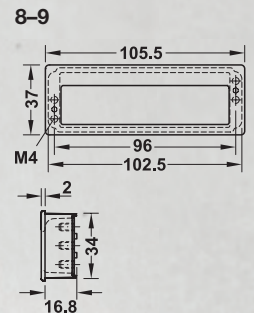
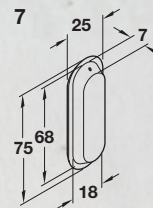
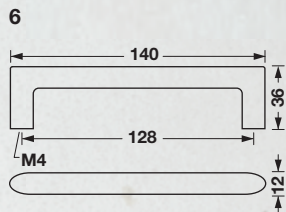
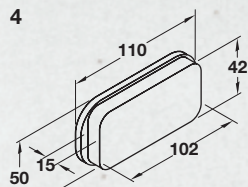
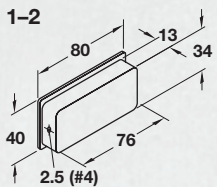



Architectural



	Finish	Material	A	C	Item No.	SRP/pc.
1	polished chrome	Zinc	174	160	110.22.202	\$32.26
2	polished chrome	Zinc	142	128	110.22.201	\$30.80
3	polished chrome	Zinc	-	-	106.59.210	\$28.97
4	matt chrome	Zinc	-	-	106.59.410	\$23.64

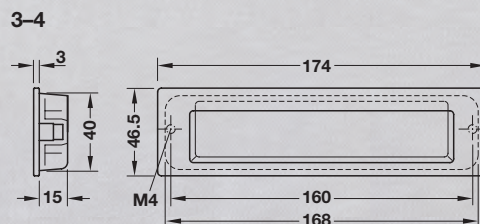
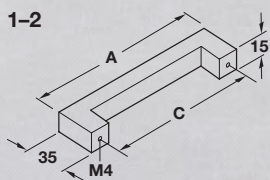

Dimensions in mm unless otherwise noted. Prices subject to change.



Architectural



	Finish	Material	A	C	Item No.	SRP/pc.
1	matt	Stainless Steel	102	96	116.11.635	\$33.14
2	matt	Stainless Steel	134	128	116.11.644	\$38.62
3	matt	Stainless Steel	198	192	116.11.662	\$47.48
4	matt	Stainless Steel	262	256	116.11.671	\$58.98
5	satin nickel/black	Brass	-	-	151.12.606	\$136.50
6	matt chrome	Zinc	-	-	151.36.222	\$38.72
7	matt nickel, antimicrobial	Zinc	-	-	151.09.610	\$41.56
8	satin nickel	Zinc & Steel	-	-	151.67.001	\$62.48

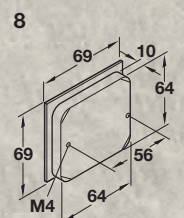
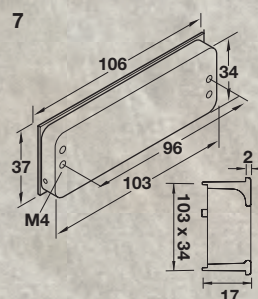
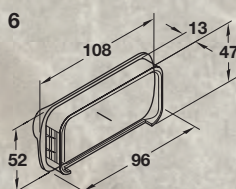
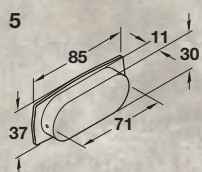
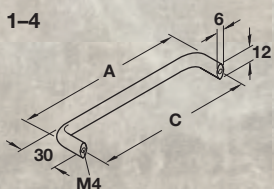



Architectural

	Finish
1	stainless steel look
2	matt
3	satin nickel
4	matt nickel

	Material
1	Zinc
2	Stainless Steel
3	Zinc, Steel
4	Brass

	Item No.	SRP/pc.
1	151.11.671	\$74.14
2	100.51.025	\$151.44
3	151.67.602	\$95.56
4	136.87.619	\$20.42

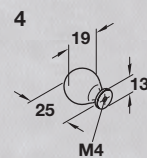
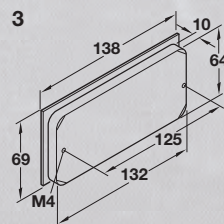
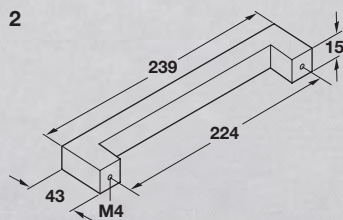
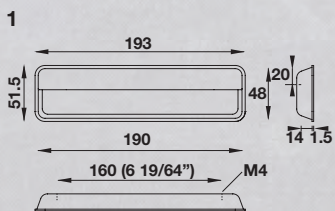



Architectural **NEW**

	Finish	Material	A	C	Item No.	SRP/pc.
1	matt	Stainless Steel 304	192	160	115.39.050	\$37.06
2	matt	Stainless Steel 304	224	192	115.39.051	\$38.14
3	matt	Stainless Steel 304	288	256	115.39.052	\$40.98
4	matt	Stainless Steel 304	352	320	115.39.053	\$42.62

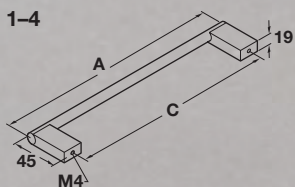



Architectural **NEW**

	Finish	Material	A	C	Item No.	SRP/pc.
1	matt	Stainless Steel 304	424	392	115.39.054	\$46.04
2	matt	Stainless Steel 304	524	492	115.39.055	\$47.12
3	matt	Stainless Steel 304	824	792	115.39.058	\$56.14

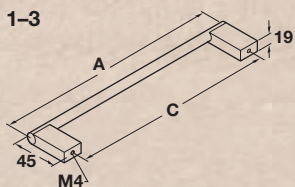

Dimensions in mm unless otherwise noted. Prices subject to change.

FARMHOUSE

Shiplap. Heirlooms. Dinner bells. Farmhouse style highlights a tangle of whites and weathered woods, where vintage or shabby chic elements such as a floral paper or a fancy rug complement bead board and mullioned windows. Deco features cup pulls or knobs in warm coppers, bronzes, polished nickel and even vintage-style glass.







Mulberry

BY HÄFELE

	Finish	Material	A	B	C	D	Item No.	SRP/pc.
1	polished nickel	Brass	136	25	128	16.5	155.02.153	\$48.36
2	polished nickel	Brass	170	26	160	17	155.02.163	\$50.72
3	polished nickel	Brass	77	20	64	34	151.40.203	\$26.98
4	polished nickel	Brass	115	23	96	42	151.40.204	\$50.60
5	polished nickel	Brass	204	25	192	42	151.40.207	\$67.30
6	brushed brass	Brass	202	33	192	42	155.02.190	\$70.50
7	brushed brass	Brass	77	20	64	35	151.40.633	\$28.10
8	brushed brass	Brass	115	23	96	42	151.40.634	\$53.12
9	polished nickel	Brass	34	-	32	32	123.02.700	\$22.80
10	polished nickel	Brass	37	-	38	38	123.02.710	\$29.64
11	brushed brass	Brass	34	-	32	32	155.02.252	\$22.80
12	brushed brass	Brass	37	-	38	38	123.02.670	\$30.40

Note

Refer to page 258 for matching appliance pulls.

1-2

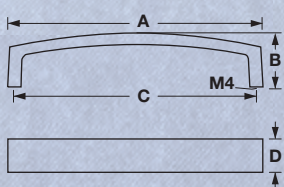

3-8

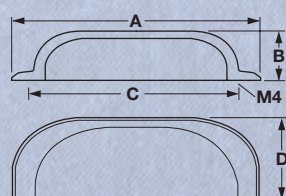

9-12

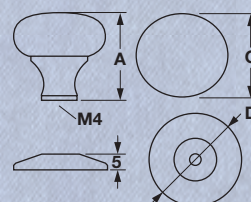



Mulberry

BY HÄFELE

	Finish	Material	A	B	C	D	Item No.	SRP/pc.
1	brushed nickel	Brass	136	25	128	17	155.02.150	\$28.92
2	brushed nickel	Brass	168	26	160	17	155.02.160	\$29.50
3	brushed nickel	Brass	77	20	64	34	151.40.603	\$24.78
4	brushed nickel	Brass	115	23	96	41	151.40.604	\$46.18
5	brushed nickel	Brass	204	25	192	42	151.40.607	\$74.06
6	brushed brass	Brass	136	25	128	16.5	116.35.665	\$50.36
7	brushed brass	Brass	168	26	160	17	155.02.162	\$52.84
8	brushed nickel	Brass	34	-	32	32	123.02.600	\$27.30
9	brushed nickel	Brass	40	-	38	38	155.02.260	\$36.47

Note

Refer to page 258 for matching appliance pulls.

1-2, 6-7

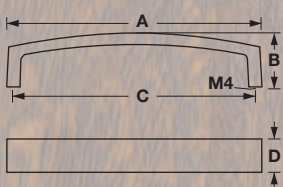

3-5

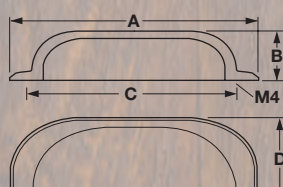

8-9

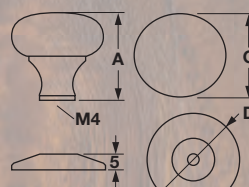



Farmhouse

BY HÄFELE - 4

	Finish	Material	Item No.	SRP/pc.
1	oil-rubbed bronze	Zinc	151.90.351	\$3.87
2	pewter	Zinc	151.90.951	\$4.04
3	natural	Maple	196.74.107	\$6.20
4	matt nickel	Zinc	103.05.620	\$28.74

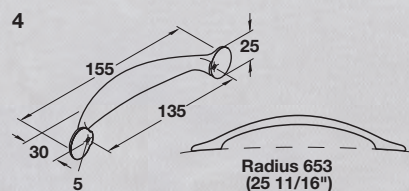
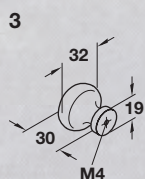
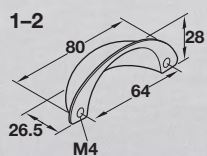



Farmhouse

BY HÄFELE - 6, 9

	Finish	Material	Item No.	SRP/pc.
1	matt nickel	Zinc	103.06.600	\$19.05
2	dark oil-rubbed bronze	Zinc	103.06.300	\$17.86
3	polished nickel	Zinc	103.06.700	\$18.00
4	polished nickel	Zinc	134.09.730	\$7.76
5	matt nickel	Zinc	134.09.633	\$7.54
6*	rustic copper	Zinc	134.09.001	\$11.04
7	dark oil-rubbed bronze	Zinc	134.09.330	\$8.23
8	dark oil-rubbed bronze	Zinc	105.61.300	\$19.39
9*	rustic copper	Zinc	105.61.014	\$16.18
10	matt nickel	Zinc	105.61.600	\$17.68

***Note**

Rustic copper finish is intended to look naturally worn with age and handling. The patina will vary from piece to piece.

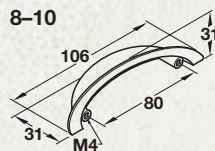
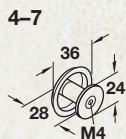
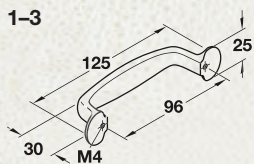



Dakota



	Finish	Material	Item No.	SRP/pc.
1	matt black	Zinc	155.01.984	\$3.55
2	antique pewter	Zinc	155.01.982	\$4.15
3	brushed nickel	Zinc	155.01.983	\$4.31
4	antique pewter	Zinc	155.01.971	\$4.69
5	brushed nickel	Zinc	155.01.973	\$5.30
6	matt black	Zinc	155.01.974	\$4.54

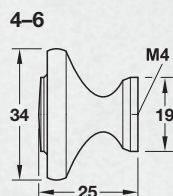
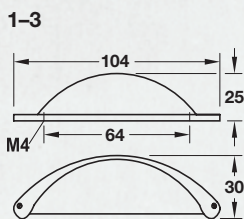



Beaulieu

	Finish	Material	A	B	C	Item No.	SRP/pc.
1	polished nickel	Brass	137	27	96	100.61.704	\$19.14
2	polished nickel	Brass	227	29	192	100.61.707	\$46.06
3	brushed nickel	Brass	137	27	96	100.61.625	\$15.83
4	brushed nickel	Brass	227	29	192	100.61.627	\$45.82
5	brushed nickel	Brass	35	30	—	123.02.631	\$28.72
6	brushed nickel	Brass	30	29	—	123.02.632	\$34.28
7	polished nickel	Brass	35	30	—	123.02.721	\$27.50
8	polished nickel	Brass	30	29	—	123.02.722	\$33.18

Note
Refer to page 258 for matching appliance pulls.

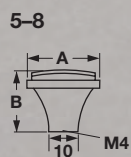
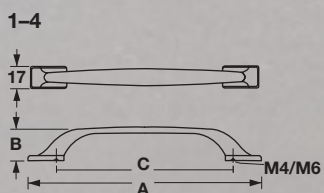



Beaulieu

	Finish	Material	A	B	C	Item No.	SRP/pc.
1	brushed brass	Brass	30	29	–	123.02.653	\$33.74
2	brushed brass	Brass	35	30	–	123.02.651	\$28.26
3	brushed brass	Brass	137	27	96	155.02.200	\$16.00
4	brushed brass	Brass	165	29	128	155.02.210	\$30.70
5	brushed brass	Brass	227	29	192	155.02.220	\$47.80
6	polished nickel	Brass	169	29	128	100.61.705	\$29.90
7	brushed nickel	Brass	169	29	128	100.61.626	\$30.48

Note

Refer to page 258 for matching appliance pulls.

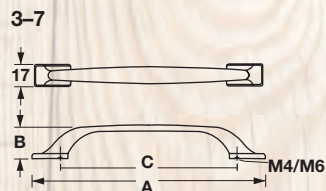
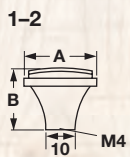



Highland Ridge

BY AMEROCK

ADA 5-9

	Finish	Material	A	B	C	D	Item No.	SRP/pc.
1	gold champagne	Zinc	-	-	-	-	133.53.152	\$17.76
2	gold champagne	Zinc	-	-	-	-	133.53.151	\$17.72
3	gold champagne	Zinc	-	-	-	-	133.53.155	\$22.86
4	gold champagne	Zinc	110	27	76 (3")	11	133.53.153	\$19.53
5	gold champagne	Zinc	132	29	96	14	133.53.154	\$21.28
6	gold champagne	Zinc	168	32	128	16	133.53.156	\$23.06
7	gold champagne	Zinc	217	33	160	17	133.53.157	\$27.60
8	polished nickel	Zinc	132	29	96	14	133.53.162	\$18.99
9	polished nickel	Zinc	168	32	128	16	133.53.022	\$19.07
10	polished nickel	Zinc	110	27	76 (3")	11	133.53.161	\$17.42

Note

Supplied with mounting screws. Refer to page 268 for matching appliance pulls.

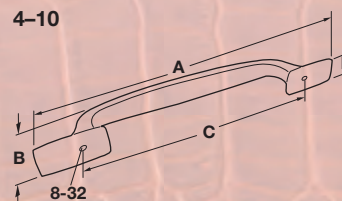
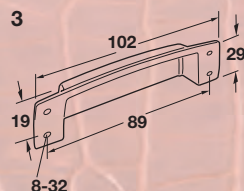
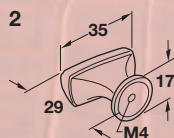
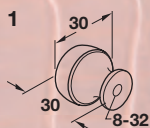



Highland Ridge

BY AMEROCK

ADA 4, 6-7

	Finish	Material	A	B	C	D	Item No.	SRP/pc.
1	black bronzed	Zinc	-	-	-	-	133.53.143	\$17.72
2	black bronzed	Zinc	-	-	-	-	133.53.144	\$16.94
3	black bronzed	Zinc	110	27	76 (3")	11	133.53.145	\$19.53
4	black bronzed	Zinc	132	29	96	14	133.53.146	\$21.28
5	black bronzed	Zinc	-	-	-	-	133.53.147	\$20.37
6	black bronzed	Zinc	168	32	128	16	133.53.148	\$23.06
7	black bronzed	Zinc	217	33	160	17	133.53.149	\$27.60

Note

Supplied with mounting screws. Refer to page 268 for matching appliance pulls.

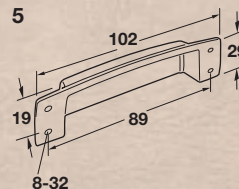
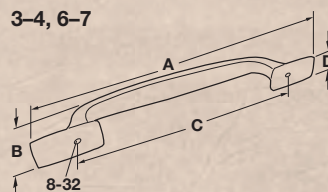
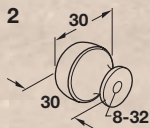
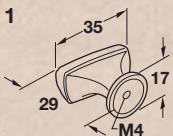



Highland Ridge

BY AMEROCK

ADA 6-9

	Finish	Material	A	B	C	D	Item No.	SRP/pc.
1	polished nickel	Zinc	-	-	-	-	133.53.159	\$15.84
2	polished nickel	Zinc	-	-	-	-	133.53.160	\$15.85
3	satin nickel	Zinc	-	-	-	-	133.53.167	\$17.72
4	satin nickel	Zinc	-	-	-	-	133.53.168	\$15.85
5	satin nickel	Zinc	110	27	76 (3")	11	133.53.169	\$19.53
6	satin nickel	Zinc	132	29	96	14	133.53.170	\$21.28
7	satin nickel	Zinc	168	32	128	16	133.53.172	\$23.06
8	satin nickel	Zinc	217	33	160	17	133.53.173	\$27.60
9	polished nickel	Zinc	217	33	160	17	133.53.165	\$24.67
10	polished nickel	Zinc	-	-	-	-	133.53.163	\$19.95
11	satin nickel	Zinc	-	-	-	-	133.53.171	\$22.86

Note

Supplied with mounting screws. Refer to page 268 for matching appliance pulls.

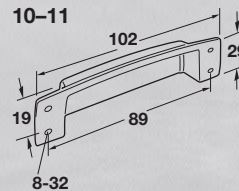
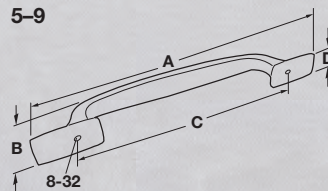
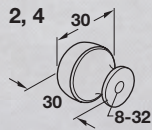
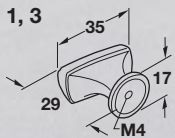



Ashby

BY AMEROCK

	Finish	Material	Item No.	SRP/pc.
1	gold champagne	Zinc	133.50.135	\$23.76
2	gunmetal	Zinc	133.50.136	\$26.42
3	satin nickel	Zinc	133.50.153	\$23.35
4	oil-rubbed bronze	Zinc	133.50.137	\$23.35
5	weathered nickel	Zinc	133.50.139	\$19.46
6	polished nickel	Zinc	133.50.138	\$23.76

Note
Supplied with 1" mounting screws.

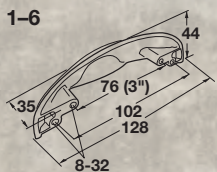



Cup Pulls

BY AMEROCK

	Finish	Material	Item No.	SRP/pc.
1	oil-rubbed bronze	Zinc	133.50.150	\$7.62
2	polished nickel	Zinc	133.50.151	\$6.82
3	satin nickel	Zinc	133.50.152	\$6.82
4	gold champagne	Zinc	133.50.147	\$6.82
5	matt black	Zinc	133.50.149	\$6.82
6	polished chrome	Zinc	133.50.134	\$6.82
7	antique silver	Zinc	133.50.146	\$6.82

Note
Supplied with 1" mounting screws.

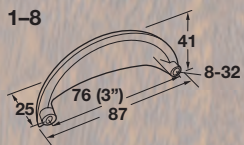

COASTAL

Breezy with a laid back beat. A palette of blues: ultra-marine, baby, turquoise combine with sandy whites, corals, and dune grass to evoke a relaxed vacation setting. Materials include linens, rope and sea glass. Deco styles include nautical themes, anchors, ropes, shell elements and geometric patterns with polished or brush brass finishes.







Coastal

BY HÄFELE - 4-5

	Finish	Material	A	C	Item No.	SRP/pc.
1	polished chrome	Zinc	172	160	107.96.233	\$12.77
2	polished chrome	Zinc	204	192	107.96.234	\$14.18
3	polished chrome	Zinc	332	320	107.96.238	\$24.76
4	white/polished chrome	Top/Base: Glass/Zinc	-	-	131.14.271	\$37.58
5	white/polished chrome	Top/Base: Glass/Zinc	-	-	109.50.274	\$54.62

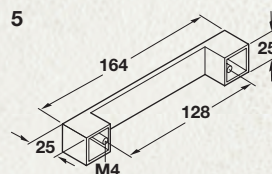
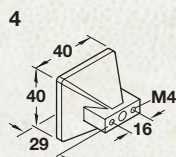
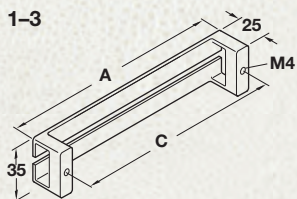



Coastal

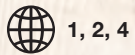

1, 2, 4

	Finish	Material	A	B	C	D	Item No.	SRP/pc.
1	white	Zinc	136	10	128	27	116.22.745	\$12.93
2	white	Zinc	104	9	96	25	116.22.736	\$11.89
3	matt nickel	Zinc	-	-	-	-	104.09.600	\$5.20
4	matt chrome	Zinc	-	-	-	-	155.00.660	\$5.53
5	matt nickel	Zinc	-	-	-	-	104.96.652	\$26.26
6	matt nickel	Zinc	-	-	-	-	104.96.651	\$19.81
7	polished chrome	Zinc	-	-	-	-	104.96.252	\$26.72
8	polished chrome	Zinc	-	-	-	-	104.96.251	\$21.10
9	matt nickel	Zinc	-	-	-	-	136.81.610	\$15.97
10	polished chrome	Zinc	-	-	-	-	136.81.210	\$18.99

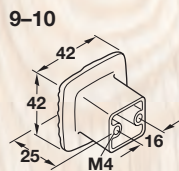
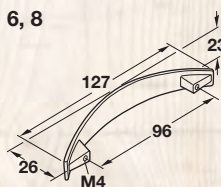
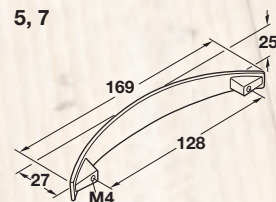
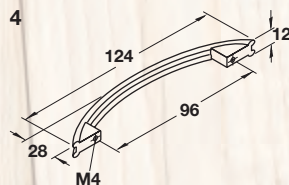
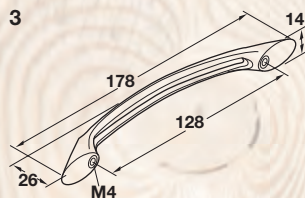
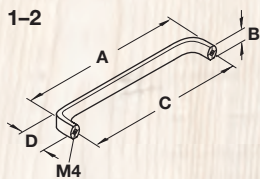

Dimensions in mm unless otherwise noted. Prices subject to change.



Sea Grass

BY AMEROCK

	Finish	Material	A	C	Item No.	SRP/pc.
1	gold champagne	Zinc	127	96	133.50.375	\$18.99
2	gold champagne	Zinc	159	128	133.50.373	\$20.61
3	satin nickel	Zinc	127	96	133.50.381	\$21.11
4	satin nickel	Zinc	159	128	133.50.379	\$22.89
5	oil-rubbed bronze	Zinc	127	96	133.50.378	\$21.11
6	oil-rubbed bronze	Zinc	159	128	133.50.376	\$19.53
7	oil-rubbed bronze	Zinc	-	-	133.50.144	\$21.11
8	satin nickel	Zinc	-	-	133.50.145	\$21.11
9	gold champagne	Zinc	-	-	133.50.143	\$18.99

Note

Supplied with 1" mounting screws

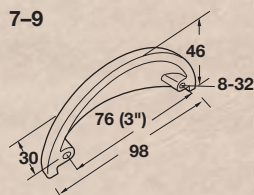
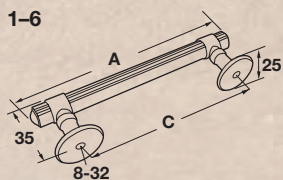



Sea Grass

BY AMEROCK

	Finish	Material	A	B	C	Item No.	SRP/pc.
1	oil-rubbed bronze	Zinc	-	-	-	133.50.377	\$22.54
2	satin nickel	Zinc	-	-	-	133.50.380	\$26.42
3	gold champagne	Zinc	-	-	-	133.50.374	\$23.76
4	gold champagne	Zinc	44	30	33	133.50.634	\$17.42
5	gold champagne	Zinc	38	25	30	133.50.633	\$15.84
6	satin nickel	Zinc	44	30	33	133.50.638	\$19.37
7	satin nickel	Zinc	38	25	30	133.50.637	\$17.59
8	oil-rubbed bronze	Zinc	44	30	33	133.50.636	\$19.37
9	oil-rubbed bronze	Zinc	38	25	30	133.50.635	\$17.59

Note
Supplied with 1" mounting screws

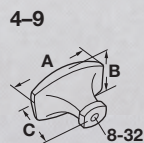
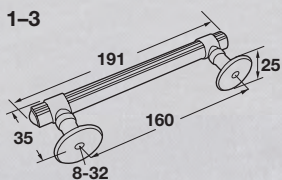

RUSTIC

Hideaway. Haven. Off the grid. The rustic style channels the earth; wood, stone, bronze, copper, cast iron, and stone in their raw forms. Finishes enhance the rough textures; hammered, weathered and distressed patinas hone the organic beauty of imperfections.







Rustic

BY HÄFELE - 3-4

	Finish
1	black oxide
2	black oxide
3	*rustic copper
4	*rustic copper
5	antique brass

	Material
1	Zinc
2	Zinc
3	Zinc
4	Zinc
5	Zinc

	Item No.	SRP/pc.
1	118.94.310	\$3.90
2	118.95.310	\$5.84
3	123.31.031	\$17.79
4	123.27.032	\$6.95
5	125.61.100	\$23.48

Note

*Rustic copper finish is intended to look naturally worn with age and handling. The patina will vary from piece to piece.

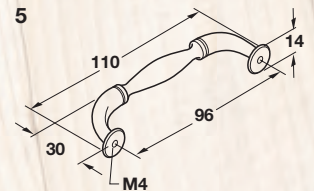
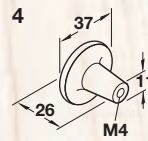
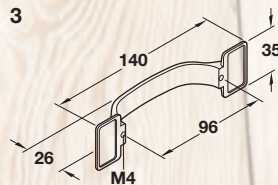
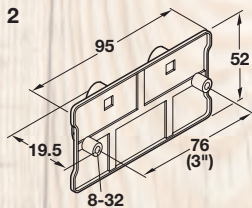
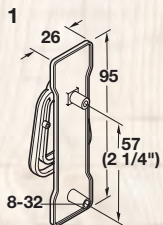



Rustic

	Finish	Material	Item No.	SRP/pc.
1	antique black	Zinc	110.93.361	\$5.23
2	oil-rubbed bronze	Zinc	110.93.161	\$5.24
3	antique satin brass	Zinc	110.93.461	\$5.23
4	satin pewter	Zinc	110.93.961	\$5.23
5	satin nickel	Zinc	110.93.661	\$5.24
6	satin nickel	Zinc	110.93.662	\$3.86
7	satin pewter	Zinc	110.93.962	\$3.86
8	antique satin brass	Zinc	110.93.462	\$3.86
9	oil-rubbed bronze	Zinc	110.93.162	\$3.86
10	antique black	Zinc	110.93.362	\$3.86

Note
Supplied with 1" mounting screws.

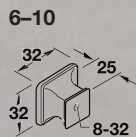
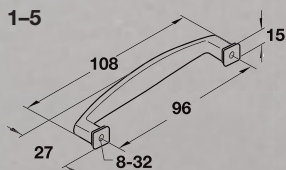



Arcadian

- | | Finish |
|---|----------------|
| 1 | old bronze |
| 2 | brushed bronze |
| 3 | natural |
| 4 | old bronze |
| 5 | brushed bronze |
| 6 | natural |

- | | Material |
|---|-----------------|
| 1 | Brass |
| 2 | Bronze |
| 3 | Britannium |
| 4 | Brass |
| 5 | Bronze |
| 6 | Britannium |

- | | Item No. | SRP/pc. |
|---|-----------------|----------------|
| 1 | 151.92.100 | \$46.52 |
| 2 | 116.61.925 | \$61.20 |
| 3 | 151.92.880 | \$61.10 |
| 4 | 125.82.100 | \$30.62 |
| 5 | 116.61.924 | \$37.68 |
| 6 | 125.82.900 | \$35.46 |

Note
Refer to page 259 for matching appliance pulls.

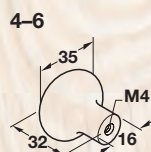
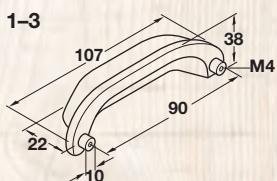



Arcadian

	Finish	Material	A	B	C	D	Item No.	SRP/pc.
1	old bronze	Brass	103	30	78	20	116.61.100	\$35.04
2	natural	Britannium	103	30	78	20	116.61.000	\$39.88
3	brushed bronze	Bronze	103	30	78	20	116.61.920	\$41.36
4	old bronze	Brass	154	35	128	22	116.61.102	\$45.40
5	natural	Britannium	154	35	128	22	116.61.002	\$48.18
6	brushed bronze	Bronze	154	35	128	22	116.61.921	\$57.22

Note
Refer to page 259 for matching appliance pulls.

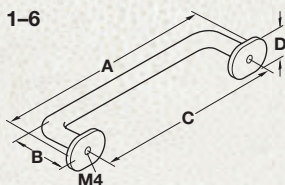



Blackrock

BY AMEROCK

ADA 4

	Finish	Material	A	B	C	D	Item No.	SRP/pc.
1	black bronzed	Zinc	30	27	-	30	133.50.221	\$11.08
2	black bronzed	Zinc	38	33	-	38	133.50.222	\$15.80
3	black bronzed	Zinc	95	27	76 (3")	14	133.50.163	\$11.25
4	black bronzed	Zinc	117	30	96	14	133.50.164	\$12.66
5	polished nickel	Zinc	30	27	-	30	133.53.068	\$11.08
6	polished nickel	Zinc	38	33	-	38	133.53.070	\$17.59
7	gold champagne	Zinc	38	33	-	38	133.53.060	\$17.59
8	gold champagne	Zinc	30	27	-	30	133.53.058	\$11.08

Note

Supplied with 1" mounting screws. Refer to page 264 for matching appliance pulls.

1-2, 5-8

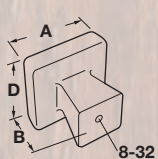

3-4

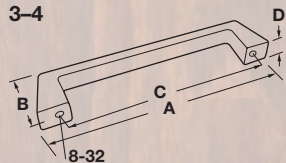



Blackrock

BY AMEROCK

ADA 2-4, 6-7

	Finish	Material	A	B	C	D	Item No.	SRP/pc.
1	oil-rubbed bronze	Zinc	95	27	76 (3")	14	133.50.167	\$11.08
2	oil-rubbed bronze	Zinc	117	30	96	14	133.50.168	\$12.66
3	oil-rubbed bronze	Zinc	151	30	128	16	133.50.165	\$14.23
4	oil-rubbed bronze	Zinc	184	32	160	16	133.50.166	\$15.84
5	satin nickel	Zinc	184	32	160	16	133.50.170	\$15.98
6	satin nickel	Zinc	151	30	128	16	133.50.169	\$14.23
7	satin nickel	Zinc	117	30	96	14	133.50.172	\$12.66
8	satin nickel	Zinc	95	27	76 (3")	14	133.50.171	\$11.25

Note

Supplied with 1" mounting screws. Refer to page 264 for matching appliance pulls.

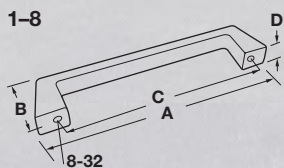



Blackrock

BY AMEROCK

ADA 1-3

	Finish	Material	A	B	C	D	Item No.	SRP/pc.
1	black bronzed	Zinc	151	30	128	16	133.50.161	\$14.23
2	black bronzed	Zinc	184	32	160	16	133.50.162	\$15.98
3	polished nickel	Zinc	184	32	160	16	133.53.075	\$17.59
4	polished nickel	Zinc	95	27	76 (3")	14	133.53.072	\$11.08
5	polished nickel	Zinc	-	-	-	-	133.53.071	\$12.32

Note

Supplied with 1" mounting screws. Refer to page 264 for matching appliance pulls.

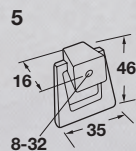
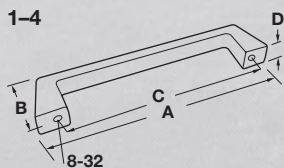



Blackrock

BY AMEROCK

ADA 5-7

	Finish	Material	A	B	C	D	Item No.	SRP/pc.
1	gold champagne	Zinc	33	27	-	-	133.53.057	\$9.50
2	gold champagne	Zinc	44	33	-	-	133.53.059	\$15.84
3	polished nickel	Zinc	44	33	-	-	133.53.069	\$15.84
4	polished nickel	Zinc	33	27	-	-	133.53.067	\$9.50
5	polished nickel	Zinc	117	30	96	14	133.53.073	\$12.66
6	polished nickel	Zinc	151	30	128	16	133.53.074	\$14.23
7	gold champagne	Zinc	117	30	96	14	133.53.063	\$12.66

Note

Supplied with 1" mounting screws. Refer to page 264 for matching appliance pulls.

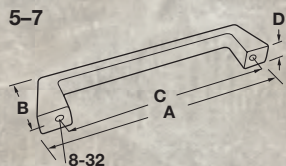
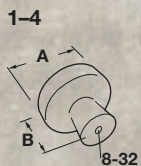



Blackrock

BY AMEROCK

	Finish	Material	A	B	D	Item No.	SRP/pc.
1	oil-rubbed bronze	Zinc	30	27	30	133.50.225	\$11.08
2	oil-rubbed bronze	Zinc	33	27	—	133.50.227	\$9.50
3	oil-rubbed bronze	Zinc	38	33	38	133.50.226	\$15.84
4	oil-rubbed bronze	Zinc	44	33	—	133.50.228	\$15.84
5	oil-rubbed bronze	Zinc	—	—	—	133.50.653	\$10.52
6	satin nickel	Zinc	—	—	—	133.50.654	\$9.40
7	satin nickel	Zinc	38	33	38	133.50.230	\$15.80
8	satin nickel	Zinc	44	33	—	133.50.232	\$14.25
9	satin nickel	Zinc	30	27	30	133.50.229	\$11.08
10	satin nickel	Zinc	33	27	—	133.50.231	\$9.50

Note
Supplied with 1" mounting screws. Refer to page 264 for matching appliance pulls.

1, 3, 7, 9

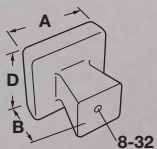

2, 4, 8, 10

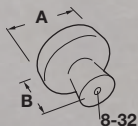

5-6

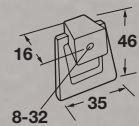



Blackrock

BY AMEROCK

ADA 2-3

	Finish	Material	A	B	C	D	Item No.	SRP/pc.
1	gold champagne	Zinc	95	27	76 (3")	14	133.53.062	\$11.08
2	gold champagne	Zinc	151	30	128	16	133.53.064	\$14.23
3	gold champagne	Zinc	184	32	160	16	133.53.065	\$17.59
4	gold champagne	Zinc	-	-	-	-	133.53.061	\$12.32
5	black bronzed	Zinc	-	-	-	-	133.50.652	\$10.52
6	black bronzed	Zinc	33	-	27	-	133.50.223	\$9.50
7	black bronzed	Zinc	44	-	33	-	133.50.224	\$11.88

Note

Supplied with 1" mounting screws. Refer to page 264 for matching appliance pulls.

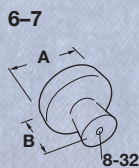
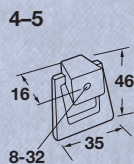
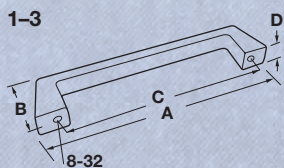



Kane

BY AMEROCK

ADA 5-10

	Finish	Material	A	B	C	D	Item No.	SRP/pc.
1	oil-rubbed bronze	Zinc	-	-	-	-	133.50.140	\$14.06
2	satin nickel	Zinc	-	-	-	-	133.50.141	\$14.06
3	oil-rubbed bronze	Zinc	-	-	-	-	133.50.609	\$9.50
4	satin nickel	Zinc	-	-	-	-	133.50.610	\$9.50
5	oil-rubbed bronze	Zinc	113	29	96	16	133.50.342	\$11.08
6	oil-rubbed bronze	Zinc	144	30	128	17	133.50.340	\$12.66
7	oil-rubbed bronze	Zinc	178	32	160	17	133.50.341	\$14.23
8	satin nickel	Zinc	178	32	160	17	133.50.344	\$14.23
9	satin nickel	Zinc	144	30	128	17	133.50.343	\$12.66
10	satin nickel	Zinc	113	29	96	16	133.50.345	\$11.08

Note
Supplied with 1" mounting screws.

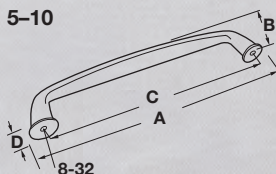
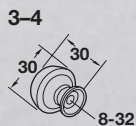
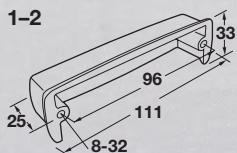



Inspirations

BY AMEROCK

	Finish	Material	Item No.	SRP/pc.
1	wrought iron dark	Zinc	133.50.293	\$9.50
2	satin nickel	Zinc	133.50.299	\$9.50
3	oil-rubbed bronze	Zinc	133.50.297	\$9.50
4	black matt	Zinc	133.50.295	\$9.50
5	weathered nickel	Zinc	133.50.300	\$9.50
6	wrought iron dark	Zinc	133.50.315	\$9.50
7	black matt	Zinc	133.50.317	\$9.50
8	oil-rubbed bronze	Zinc	133.50.319	\$9.50
9	weathered nickel	Zinc	133.50.322	\$9.50
10	satin nickel	Zinc	133.50.321	\$9.50

Note
Supplied with 1" mounting screws.

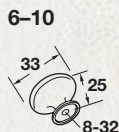
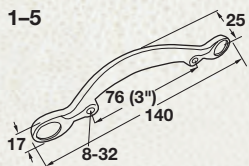



Conrad/ Inspirations

BY AMEROCK

	Finish	Material	Item No.	SRP/pc.
1	oil-rubbed bronze	Zinc	133.50.251	\$9.50
2	satin nickel	Zinc	133.50.252	\$9.69
3	oil-rubbed bronze	Zinc	133.50.301	\$7.29
4	satin nickel	Zinc	133.50.302	\$7.29
5	black matt	Zinc	133.50.294	\$9.12
6	satin nickel	Zinc	133.50.298	\$9.12
7	oil-rubbed bronze	Zinc	133.50.296	\$9.12
8	black matt	Zinc	133.50.316	\$6.40
9	satin nickel	Zinc	133.50.320	\$6.40

Note
Supplied with 1" mounting screws.

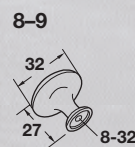
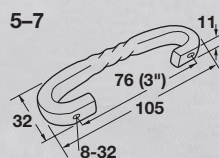
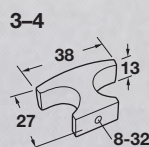
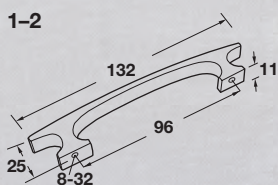



Nature's Splendor

BY AMEROCK

	Finish	Material	Item No.	SRP/pc.
1	oil-rubbed bronze	Zinc	133.50.354	\$9.50
2	satin nickel	Zinc	133.50.355	\$7.85
3	weathered nickel	Zinc	133.50.356	\$9.50
4	oil-rubbed bronze	Zinc	133.50.615	\$6.31
5	satin nickel	Zinc	133.50.616	\$7.02
6	weathered nickel	Zinc	133.50.617	\$6.31

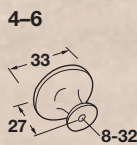
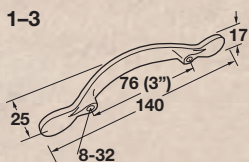

REVIVAL

Whether it is Greek columns or the Gothic rose window, revival styles continue to add signature elements to many designs. In deco, revival style details include ornate scroll work or the hammered Spanish “clavos” or nail heads. Materials run the gamut from a hand or cast iron to a polished gold filigree.







Revival

ALLISON BY AMEROCK - 3-6

	Finish	Material	A	C	Item No.	SRP/pc.
1	oil-rubbed bronze	Zinc	118	96	125.67.351	\$4.55
2	oil-rubbed bronze	Zinc	150	128	125.67.352	\$5.70
3	oil-rubbed bronze	Zinc	-	-	133.50.155	\$6.31
4	satin nickel	Zinc	-	-	133.50.158	\$6.31
5	satin nickel	Zinc	-	-	133.50.220	\$5.71
6	oil-rubbed bronze	Zinc	-	-	133.50.214	\$5.71

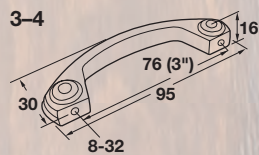
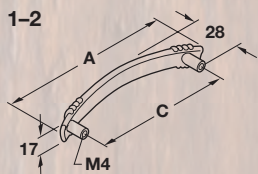

Note
Supplied with 1" mounting screws.

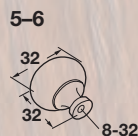

Note
Supplied with 1" mounting screws.



Revitalize

BY AMEROCK

ADA 4-9

	Finish	Material	A	B	C	D	Item No.	SRP/pc.
1	oil-rubbed bronze	Zinc	-	-	-	-	133.50.628	\$9.50
2	oil-rubbed bronze	Zinc	-	-	-	-	133.50.629	\$9.50
3	oil-rubbed bronze	Zinc	94	35	76(3")	14	133.50.359	\$9.50
4	oil-rubbed bronze	Zinc	110	37	96	16	133.50.360	\$12.66
5	oil-rubbed bronze	Zinc	143	40	128	17	133.50.357	\$14.23
6	oil-rubbed bronze	Zinc	173	41	160	19	133.50.358	\$15.84
7	gold champagne	Zinc	173	41	160	19	133.50.366	\$15.84
8	gold champagne	Zinc	143	40	128	17	133.50.365	\$14.23
9	gold champagne	Zinc	110	37	96	16	133.50.369	\$12.66
10	gold champagne	Zinc	94	35	76(3")	14	133.50.368	\$9.50

Note

Supplied with 1" mounting screws. Refer to page 263 for matching appliance pulls.

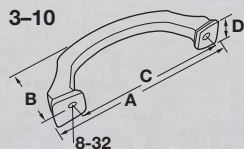
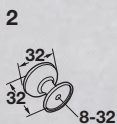
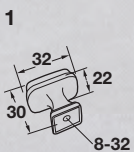



Revitalize

BY AMEROCK

ADA 2-4

	Finish	Material	A	B	C	D	Item No.	SRP/pc.
1	satin nickel	Zinc	94	35	76(3")	14	133.50.363	\$9.50
2	satin nickel	Zinc	110	37	96	16	133.50.364	\$12.66
3	satin nickel	Zinc	143	40	128	17	133.50.361	\$14.23
4	satin nickel	Zinc	173	41	160	19	133.50.362	\$15.84
5	gold champagne	Zinc	-	-	-	-	133.50.626	\$9.50
6	gold champagne	Zinc	-	-	-	-	133.50.627	\$9.50
7	satin nickel	Zinc	-	-	-	-	133.50.630	\$9.50
8	satin nickel	Zinc	-	-	-	-	133.50.631	\$9.50

Note

Supplied with 1" mounting screws. Refer to page 263 for matching appliance pulls.

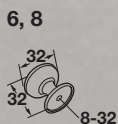
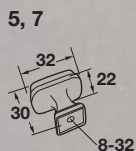
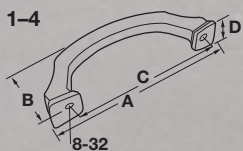



Revitalize

BY AMEROCK

ADA 1-3, 5-8

	Finish	Material	A	B	C	D	Item No.	SRP/pc.
1	black bronzed	Zinc	173	41	160	19	133.53.202	\$17.59
2	black bronzed	Zinc	143	40	128	17	133.53.201	\$14.23
3	black bronzed	Zinc	110	37	96	16	133.53.200	\$12.66
4	black bronzed	Zinc	94	35	76 (3")	14	133.53.199	\$9.50
5	polished nickel	Zinc	173	41	160	19	133.53.210	\$17.59
6	polished nickel	Zinc	143	40	128	17	133.53.209	\$14.23
7	polished nickel	Zinc	110	37	96	16	133.53.208	\$12.66
8	polished nickel	Zinc	94	35	76 (3")	14	133.53.207	\$9.50
9	polished nickel	Zinc	-	-	-	-	133.53.205	\$9.50
10	polished nickel	Zinc	-	-	-	-	133.53.206	\$9.50
11	black bronzed	Zinc	-	-	-	-	133.53.197	\$9.50
12	black bronzed	Zinc	-	-	-	-	133.53.198	\$9.50

Note

Supplied with 1" mounting screws. Refer to page 263 for matching appliance pulls.

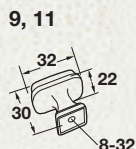
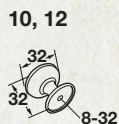
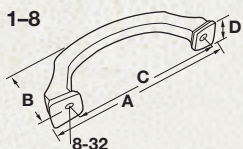



Wells

BY AMEROCK

	Finish	Material	A	B	C	D	Item No.	SRP/pc.
1	oil-rubbed bronze	Zinc	122	32	96	22	133.50.399	\$19.20
2	oil-rubbed bronze	Zinc	194	40	160	24	133.50.398	\$22.65
3	polished nickel	Zinc	194	40	160	24	133.50.601	\$19.81
4	polished nickel	Zinc	122	32	96	22	133.50.602	\$17.28
5	polished nickel	Zinc	-	-	-	-	133.50.647	\$12.96
6	oil-rubbed bronze	Zinc	-	-	-	-	133.50.645	\$13.52

Note
Supplied with 1" mounting screws.

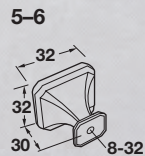
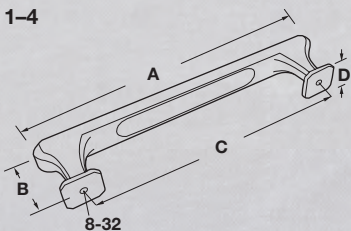



Wells

BY AMEROCK

	Finish	Material	A	B	C	D	Item No.	SRP/pc.
1	gunmetal	Zinc	-	-	-	-	133.50.643	\$14.40
2	satin nickel	Zinc	-	-	-	-	133.50.649	\$12.96
3	satin nickel	Zinc	122	32	96	22	133.50.605	\$17.28
4	satin nickel	Zinc	157	37	128	22	133.50.603	\$18.51
5	satin nickel	Zinc	194	40	160	24	133.50.604	\$20.27
6	gunmetal	Zinc	194	40	160	24	133.50.395	\$22.65
7	gunmetal	Zinc	157	37	128	22	133.50.394	\$21.14
8	gunmetal	Zinc	122	32	96	22	133.50.396	\$19.20

Note
Supplied with 1" mounting screws.

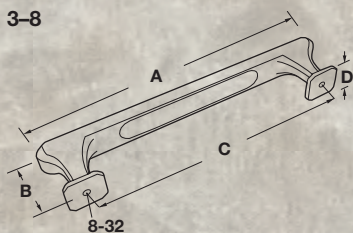

CLASSIC

Steadfast. Sacred and cherished. Classic or traditional style is embraced as a safeguard against the mercurial fickleness of fads. Classic deco standards include: beveled edges, spherical turns and bail pulls. Materials include solid brass, pewter, nickel and bronze.







Artisan

BY HÄFELE

	Finish	Material	A	B	C	D	Item No.	SRP/pc.
1	antique brass	Zinc	32	30	–	16	125.86.101	\$9.77
2	antique brass	Zinc	48	37	–	19	125.86.102	\$18.33
3	oil-rubbed bronze	Zinc	32	30	–	16	125.86.303	\$13.18
4	oil-rubbed bronze	Zinc	48	37	–	19	125.86.304	\$21.04
5	oil-rubbed bronze	Zinc	108	30	96	11	125.87.334	\$16.83
6	oil-rubbed bronze	Zinc	150	18	128	45	125.87.354	\$23.16
7	antique brass	Zinc	150	18	128	45	125.87.152	\$18.03
8	antique brass	Zinc	225	55	8"	24	125.87.102	\$69.60
9	antique brass	Zinc	148	38	128	16	125.87.101	\$24.76
10	antique brass	Zinc	108	30	96	11	125.87.132	\$9.77
11	antique brass	Zinc	88	30	3"	11	125.87.131	\$10.23

Note

Supplied with mounting screws. Refer to page 257 for matching appliance pulls.

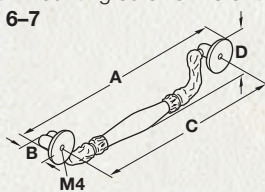
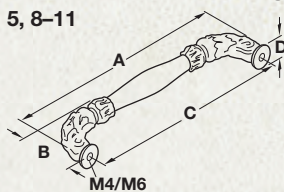
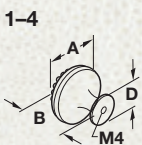



Artisan

BY HÄFELE

	Finish	Material	A	B	C	D	Item No.	SRP/pc.
1	oil-rubbed bronze	Zinc	88	30	3"	11	125.87.333	\$15.98
2	oil-rubbed bronze	Zinc	148	38	128	16	125.87.305	\$30.42
3	oil-rubbed bronze	Zinc	225	55	8"	24	125.87.306	\$83.68
4	pewter	Zinc	225	55	8"	24	125.87.902	\$69.54
5	pewter	Zinc	148	38	128	16	125.87.901	\$22.92
6	pewter	Zinc	150	18	128	45	125.87.952	\$18.03
7	pewter	Zinc	108	30	96	11	125.87.932	\$9.77
8	pewter	Zinc	88	30	3"	11	125.87.931	\$9.43
9	pewter	Zinc	32	30	-	16	125.86.901	\$9.49
10	pewter	Zinc	48	37	-	19	125.86.902	\$18.78

Note
Supplied with mounting screws. Refer to page 257 for matching appliance pulls.

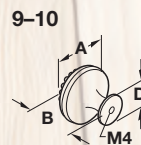
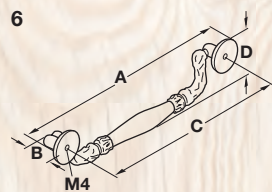
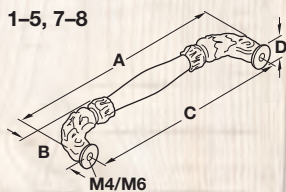

Dimensions in mm unless otherwise noted. Prices subject to change.



Bordeaux

	Finish	Material	A	B	C	D	Item No.	SRP/pc.
1	oil-rubbed bronze	Iron	-	-	-	-	125.88.343	\$30.70
2	oil-rubbed bronze	Iron	-	-	-	-	125.88.355	\$25.94
3	oil-rubbed bronze	Iron	116	34	96	20	125.88.311	\$12.95
4	oil-rubbed bronze	Iron	153	40	128	25	125.88.312	\$26.54
5	oil-rubbed bronze	Iron	229	52	8"	28	125.88.314	\$42.18
6	pewter	Iron	229	52	8"	28	125.88.904	\$32.60
7	pewter	Iron	153	40	128	25	125.88.902	\$18.76
8	pewter	Iron	116	34	96	20	125.88.901	\$11.79
9	pewter	Iron	-	-	-	-	125.88.951	\$16.69
10	pewter	Iron	-	-	-	-	125.88.942	\$28.96

Note

Supplied with mounting screws. Refer to page 257 for matching appliance pulls.

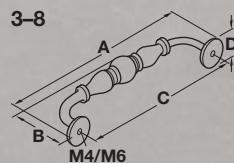
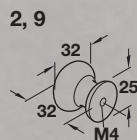
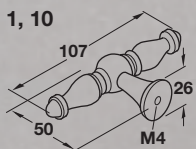



Classic

	Finish	Material	Item No.	SRP/pc.
1	polished	Brass	121.88.868	\$14.82
2	polished chrome	Brass	121.88.260	\$15.51
3	stainless steel	Brass	121.88.662	\$14.98
4	stainless steel look	Brass	137.42.606	\$14.52
5	antique bronze	Zinc	122.18.129	\$13.48
6	dark oil-rubbed bronze	Zinc	120.17.370	\$8.86
7	oil-rubbed bronze	Zinc	120.70.303	\$19.33
8	antique brass	Brass	125.16.101	\$16.82

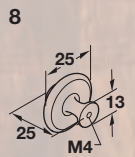
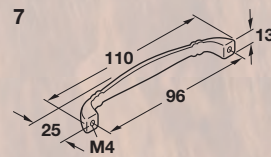
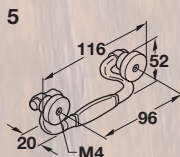
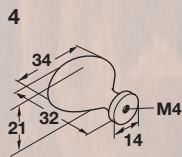
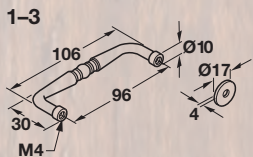

Dimensions in mm unless otherwise noted. Prices subject to change.



Classic

	Finish	Material	Item No.	SRP/pc.
1	rustic brass	Brass	125.73.113	\$7.49
2	rustic brass	Brass	125.72.102	\$19.01
3	antique brass	Zinc	125.28.100	\$2.00
4	antique english	Zinc	120.62.110	\$5.03
5	antique english	Zinc	118.30.103	\$3.55
6	stainless steel	Brass	155.01.540	\$9.02
7	polished chrome	Brass	155.01.543	\$8.84
8	antique english	Zinc	107.13.112	\$4.03
9	oil-rubbed bronze	Zinc	110.93.192	\$3.78
10	oil-rubbed bronze	Zinc	110.93.191	\$4.89

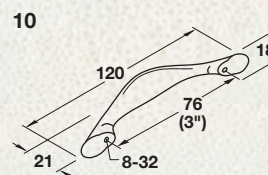
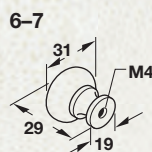
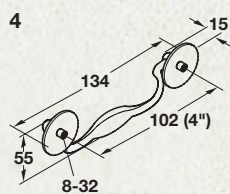
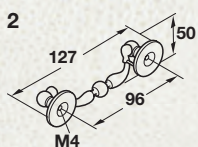
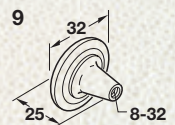
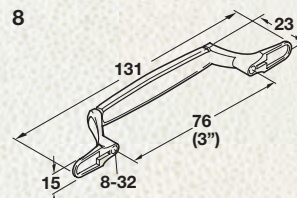
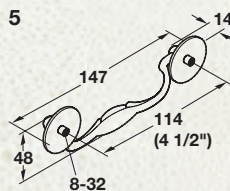
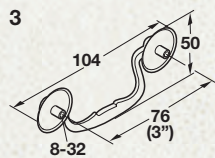
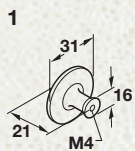



Classic

	Finish	Material	Item No.	SRP/pc.
1	pewter & copper	Zinc	121.90.902	\$6.94
2	dark oil-rubbed bronze	Zinc	121.90.301	\$6.79
3	black antique	Zinc	121.90.302	\$6.14
4	black antique	Zinc	134.33.320	\$5.05
5	dark oil-rubbed bronze	Zinc	134.33.321	\$5.64
6	pewter & copper	Zinc	134.33.940	\$6.81

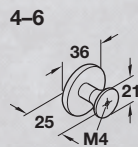
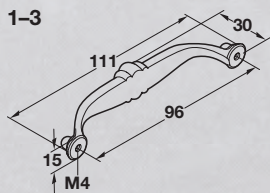



Classic

	Finish	Material	A	B	D	Item No.	SRP/pc.
1	polished chrome	Zinc	-	-	-	125.61.251	\$2.04
2	stainless steel look	Zinc	-	-	-	125.61.051	\$2.41
3	dark oil-rubbed bronze	Zinc	-	-	-	125.61.351	\$2.04
4	dark oil-rubbed bronze	Zinc	-	-	-	121.46.350	\$3.59
5	stainless steel look	Zinc	-	-	-	134.45.602	\$3.56
6	stainless steel	Zinc	35	35	23	137.45.002	\$3.27
7	dark oil-rubbed bronze	Zinc	30	30	19	137.45.331	\$2.42

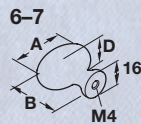
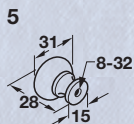
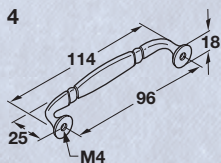
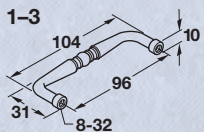



Granby

BY AMEROCK

ADA 1-7

	Finish	Material	A	B	C	D	Item No.	SRP/pc.
1	oil-rubbed bronze	Zinc	106	37	96	16	133.50.285	\$7.92
2	oil-rubbed bronze	Zinc	141	40	128	19	133.50.283	\$9.50
3	satin nickel	Zinc	106	37	96	16	133.50.292	\$7.92
4	satin nickel	Zinc	141	40	128	19	133.50.290	\$9.50
5	polished nickel	Zinc	106	37	96	16	133.50.289	\$7.92
6	polished nickel	Zinc	141	40	128	19	133.50.286	\$9.50
7	polished nickel	Zinc	175	44	160	22	133.50.287	\$14.23
8	polished nickel	Zinc	86	33	76 (3")	14	133.50.288	\$4.74
9	satin nickel	Zinc	86	33	76 (3")	14	133.50.291	\$4.74
10	oil-rubbed bronze	Zinc	86	33	76 (3")	14	133.50.284	\$4.74

Note
Supplied with 1" mounting screws.

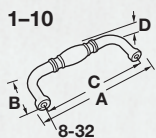



Blythe

BY AMEROCK

	Finish	Material	A	B	C	D	Item No.	SRP/pc.
1	satin nickel	Zinc	92	32	76 (3")	13	133.50.181	\$6.48
2	satin nickel	Zinc	114	35	96	16	133.50.182	\$7.61
3	satin nickel	Zinc	146	40	128	17	133.50.180	\$10.05
4	polished nickel	Zinc	179	44	160	21	133.50.177	\$11.18
5	polished nickel	Zinc	76	-	-	24	133.50.235	\$9.83
6	satin nickel	Zinc	67	-	-	21	133.50.236	\$6.38

Note
Supplied with 1" mounting screws.

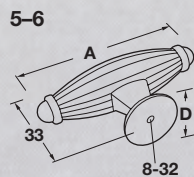
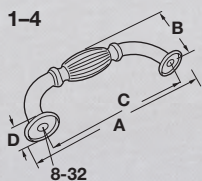



Blythe

BY AMEROCK

	Finish	Material	A	B	C	D	Item No.	SRP/pc.
1	polished nickel	Zinc	-	-	-	-	133.50.234	\$4.76
2	polished nickel	Zinc	92	32	76 (3")	13	133.50.178	\$6.43
3	polished nickel	Zinc	114	35	96	16	133.50.179	\$7.72
4	polished nickel	Zinc	146	40	128	17	133.50.176	\$9.66
5	oil-rubbed bronze	Zinc	146	40	128	17	133.50.173	\$10.05
6	oil-rubbed bronze	Zinc	114	35	96	16	133.50.175	\$7.57
7	oil-rubbed bronze	Zinc	92	32	76 (3")	13	133.50.174	\$6.48
8	oil-rubbed bronze	Zinc	-	-	-	-	133.50.233	\$6.38

Note
Supplied with 1" mounting screws.

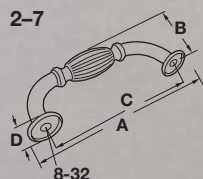
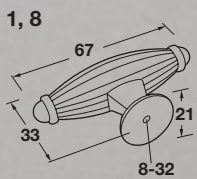



Allison

BY AMEROCK

Finish

- 1 black matt
- 2 oil-rubbed bronze
- 3 satin nickel
- 4 black matt
- 5 oil-rubbed bronze
- 6 satin nickel
- 7 black matt
- 8 oil-rubbed bronze
- 9 satin nickel

Material

- Zinc
- Zinc
- Zinc
- Zinc
- Zinc
- Zinc
- Zinc
- Zinc
- Zinc

Item No.

- 133.50.154
- 133.50.156
- 133.50.160
- 133.50.206
- 133.50.210
- 133.50.216
- 133.50.209
- 133.50.213
- 133.50.219

SRP/pc.

- \$5.84
- \$5.24
- \$5.24
- \$5.28
- \$5.27
- \$4.51
- \$2.90
- \$4.74
- \$4.74

Note

Supplied with 1" mounting screws.

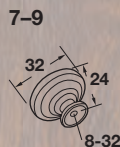
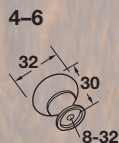
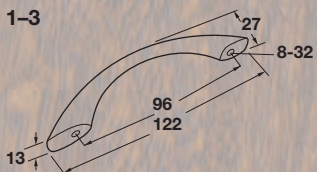



Winsome NEW

BY AMEROCK

- Finish**
- 1 oil-rubbed bronze
 - 2 matt black
 - 3 champagne bronze
 - 4 satin nickel
 - 5 polished chrome

Material	A	C	Item No.	SRP/pc.
Zinc	-	-	133.53.411	\$17.59
Zinc	-	-	133.53.359	\$14.40
Zinc	-	-	133.53.299	\$15.85
Zinc	-	-	133.53.470	\$15.85
Zinc	-	-	133.53.416	\$17.59
Zinc	135	96	133.53.471	\$18.99
Zinc	165	128	133.53.472	\$25.34
Zinc	230	192	133.53.473	\$35.21
Zinc	262	224	133.53.474	\$38.78

Note
Supplied with mounting screws.

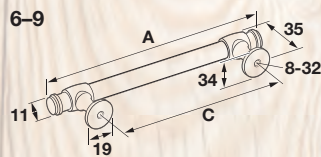
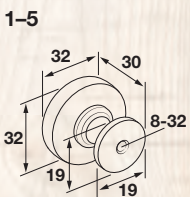



Winsome **NEW**

BY AMEROCK

	Finish	Material	A	C	Item No.	SRP/pc.
1	champagne bronze	Zinc	135	96	133.53.300	\$18.99
2	champagne bronze	Zinc	165	128	133.53.301	\$25.34
3	champagne bronze	Zinc	230	192	133.53.302	\$35.21
4	champagne bronze	Zinc	262	224	133.53.303	\$38.78
5	oil-rubbed bronze	Zinc	135	96	133.53.412	\$21.11
6	oil-rubbed bronze	Zinc	165	128	133.53.413	\$28.18
7	oil-rubbed bronze	Zinc	230	192	133.53.414	\$35.21
8	oil-rubbed bronze	Zinc	262	224	133.53.415	\$38.78

Note
Supplied with mounting screws.

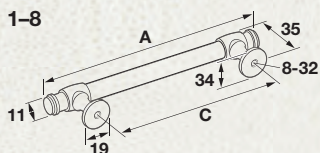



Winsome **NEW**

BY AMEROCK

	Finish	Material	A	C	Item No.	SRP/pc.
1	matt black	Zinc	135	96	133.53.360	\$18.99
2	matt black	Zinc	165	128	133.53.361	\$25.34
3	matt black	Zinc	230	192	133.53.362	\$35.21
4	matt black	Zinc	262	224	133.53.363	\$38.78
5	polished chrome	Zinc	135	96	133.53.417	\$21.11
6	polished chrome	Zinc	165	128	133.53.418	\$28.18
7	polished chrome	Zinc	230	192	133.53.419	\$35.21
8	polished chrome	Zinc	262	224	133.53.420	\$38.78

Note
Supplied with mounting screws.

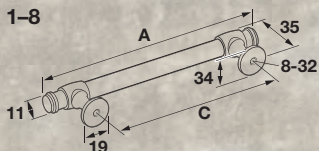

Dimensions in mm unless otherwise noted. Prices subject to change.



Renown NEW

BY AMEROCK

ADA 2-4, 6-8

- | | Finish |
|---|---------------|
| 1 | matt black |
| 2 | matt black |
| 3 | matt black |
| 4 | matt black |
| 5 | satin nickel |
| 6 | satin nickel |
| 7 | satin nickel |
| 8 | satin nickel |

- | | Material |
|---|-----------------|
| 1 | Zinc |
| 2 | Zinc |
| 3 | Zinc |
| 4 | Zinc |
| 5 | Zinc |
| 6 | Zinc |
| 7 | Zinc |
| 8 | Zinc |

	A	C	Item No.	SRP/pc.
1	-	-	133.53.364	\$14.06
2	113	96	133.53.365	\$14.06
3	144	128	133.53.366	\$21.11
4	178	160	133.53.367	\$24.67
5	-	-	133.53.475	\$14.06
6	178	160	133.53.477	\$21.11
7	144	128	133.53.478	\$24.67
8	113	96	133.53.476	\$14.06

Note
Supplied with mounting screws.

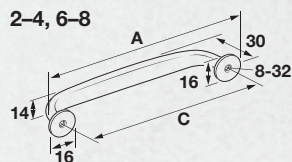
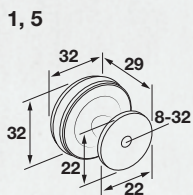



Renown NEW

BY AMEROCK

ADA 2-4, 6-8

	Finish	Material	A	C	Item No.	SRP/pc.
1	polished chrome	Zinc	-	-	133.53.421	\$14.06
2	polished chrome	Zinc	113	96	133.53.422	\$14.06
3	polished chrome	Zinc	144	128	133.53.423	\$21.11
4	polished chrome	Zinc	178	160	133.53.424	\$24.67
5	champagne bronze	Zinc	-	-	133.53.304	\$14.06
6	champagne bronze	Zinc	144	128	133.53.306	\$21.11
7	champagne bronze	Zinc	178	160	133.53.307	\$24.67
8	champagne bronze	Zinc	113	96	133.53.308	\$12.32

Note
Supplied with mounting screws.

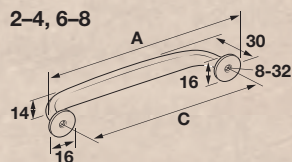
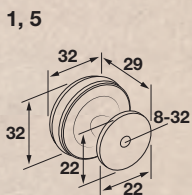

APPLIANCE PULLS

Herculean. Workhorse. Mighty. Appliance pulls are not just longer handles. These pulls are highly specialized, meticulously crafted to overcome the tight vacuum seals and heavy steel of refrigerator wood panel doors. Quality characteristics of small batch production include: longer casting time, more pressure on the cast and larger screw threads. Secure fit, smooth feel and uniform finish are the stalwarts of good appliance pull design.







Appliance Pulls NEW

BY HÄFELE

- | | Finish |
|----------|-------------------|
| 1 | brushed nickel |
| 2 | matt gold |
| 3 | oil-rubbed bronze |

- | | Material |
|----------|-----------------|
| 1 | Zinc |
| 2 | Zinc |
| 3 | Zinc |

- | | Item No. | SRP/pc. |
|----------|-----------------|----------------|
| 1 | 106.70.153 | \$25.42 |
| 2 | 106.70.163 | \$27.92 |
| 3 | 106.70.223 | \$27.96 |

Note
Refer to pages 65–66 for matching handles and knobs.

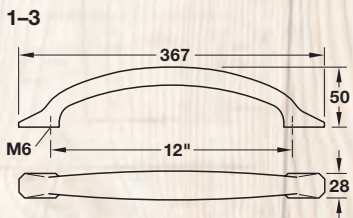



Paragon

BY HÄFELE

	Finish	Material	Item No.	SRP/pc.
1	oil-rubbed bronze	Zinc	123.08.144	\$64.44
2	polished nickel	Zinc	123.08.749	\$64.74
3	satin nickel	Zinc	123.08.444	\$60.84

Note

Supplied with mounting screws. Refer to page 67 for matching handles and knobs.

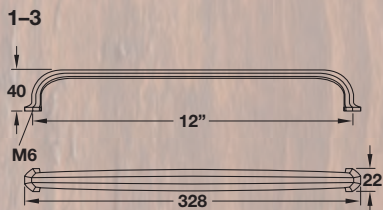

Dimensions in mm unless otherwise noted. Prices subject to change.



Artisan/ Bordeaux

BY HÄFELE - 1-3

	Finish	Material	Item No.	SRP/pc.
1	oil-rubbed bronze	Zinc	125.87.307	\$98.92
2	pewter	Zinc	125.87.903	\$91.74
3	oil-rubbed bronze	Iron	125.88.315	\$36.06
4	pewter	Iron	125.88.905	\$41.10

Note
Refer to pages 237-239 for matching handles and knobs.

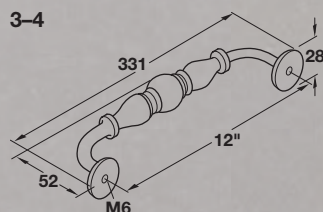
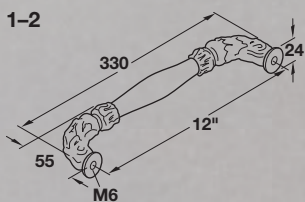



Beaulieu/ Mulberry

BY HÄFELE - 4-6

	Finish	Material	Item No.	SRP/pc.
1	brushed brass	Brass	100.61.676	\$173.78
2	polished nickel	Brass	100.61.717	\$170.12
3	brushed nickel	Brass	100.61.656	\$174.58
4	brushed brass	Brass	116.36.616	\$164.60
5	brushed nickel	Brass	116.36.606	\$164.60
6	polished nickel	Brass	116.36.206	\$162.78

Note
Refer to pages 193-194, 198-199 for matching handles and knobs.

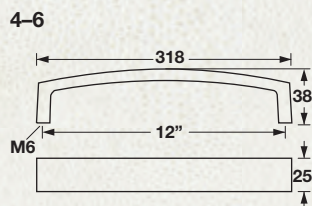
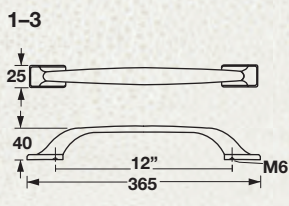

Dimensions in mm unless otherwise noted. Prices subject to change.



Arcadian

	Finish	Material	A	B	C	D	Item No.	SRP/pc.
1	old bronze	Brass	332	42	305	25	116.61.107	\$148.92
2	natural	Britannium	332	42	305	25	116.61.007	\$191.12
3	brushed bronze	Bronze	332	42	305	25	116.61.922	\$176.32
4	natural	Britannium	495	47	457	32	116.61.008	\$356.16
5	old bronze	Brass	495	47	457	32	116.61.108	\$280.14
6	brushed bronze	Bronze	495	47	457	32	116.61.923	\$331.48

Note
Refer to pages 215–216 for matching handles and knobs.

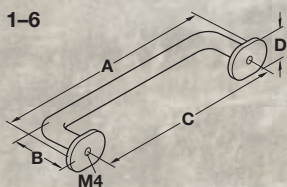



Affinity NEW

	Finish	Material	A	C	Item No.	SRP/pc.
1	satin nickel	Zinc	328	320	102.47.370	\$51.89
2	satin nickel	Zinc	488	480	102.47.380	\$64.22
3	matt gold	Zinc	328	320	102.47.372	\$51.89
4	matt gold	Zinc	488	480	102.47.382	\$64.22
5	matt black	Zinc	328	320	102.47.373	\$51.89
6	matt black	Zinc	488	480	102.47.383	\$64.22
7	polished chrome	Zinc	328	320	102.47.371	\$51.89
8	polished chrome	Zinc	488	480	102.47.381	\$64.22

Note
Refer to pages 33–34 for matching handles.

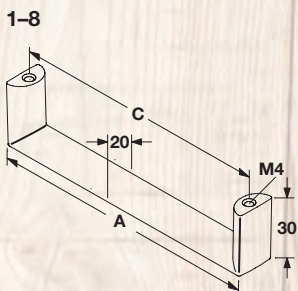

Dimensions in mm unless otherwise noted. Prices subject to change.



Appliance Pulls NEW

- Finish**
- 1 oil-rubbed bronze
 - 2 stainless steel matt
 - 3 black

- Material**
- Zinc
 - Zinc
 - Zinc

Item No.	SRP/pc.
901.00.581	\$36.80
901.00.586	\$45.80
901.00.583	\$40.32

Note
Supplied with 50 mm M6 screws.

1-3

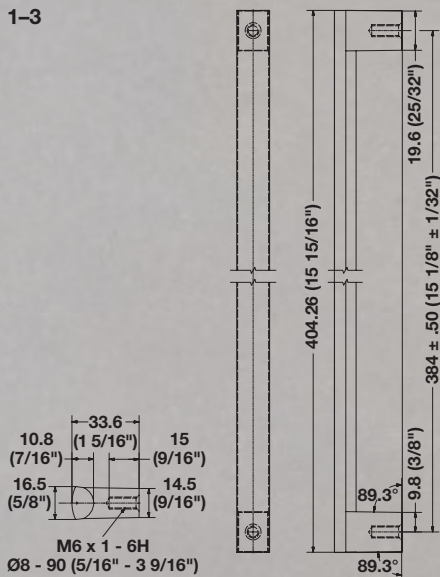



Cyprus

BY AMEROCK

	Finish	Material	Item No.	SRP/pc.
1	black bronzed	Zinc	133.53.111	\$193.68
2	satin nickel	Zinc	133.53.123	\$193.68
3	gold champagne	Zinc	133.53.116	\$193.68
4	polished nickel	Zinc	133.53.121	\$193.68

Note

Supplied with mounting screws. Refer to pages 37–38 for matching handles and knobs.

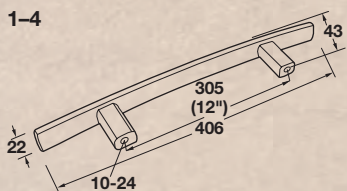

Dimensions in mm unless otherwise noted. Prices subject to change.



Revitalize

BY AMEROCK

	Finish	Material	Item No.	SRP/pc.
1	black bronzed	Zinc	133.53.203	\$193.68
2	gold champagne	Zinc	133.53.204	\$193.68
3	polished nickel	Zinc	133.53.211	\$193.68
4	satin nickel	Zinc	133.53.212	\$193.68

Note
Supplied with mounting screws. Refer to pages 230–232 for matching handles and knobs.

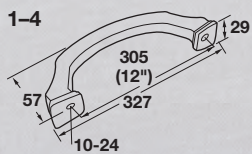



Blackrock

BY AMEROCK

	Finish	Material	Item No.	SRP/pc.
1	gold champagne	Zinc	133.53.066	\$193.68
2	polished nickel	Zinc	133.53.076	\$193.68
3	satin nickel	Zinc	133.53.003	\$170.69
4	oil-rubbed bronze	Zinc	133.50.331	\$193.68
5	black bronzed	Zinc	133.53.056	\$183.82

Note
Supplied with mounting screws. Refer to pages 217–222 for matching handles and knobs.

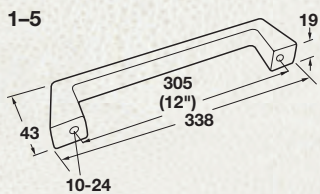

Dimensions in mm unless otherwise noted. Prices subject to change.



Mulholland

BY AMEROCK

	Finish	Material	Item No.	SRP/pc.
1	gold champagne	Zinc	133.53.187	\$193.68
2	satin nickel	Zinc	133.53.196	\$193.68
3	polished nickel	Zinc	133.53.194	\$193.68
4	black bronzed	Zinc	133.53.180	\$193.68
5	oil-rubbed bronze	Zinc	133.53.251	\$137.74

Note
Supplied with mounting screws. Refer to pages 82–84 for matching handles and knobs.

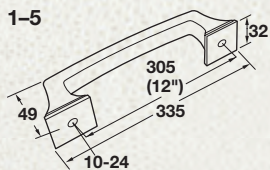



Candler

BY AMEROCK

	Finish	Material	Item No.	SRP/pc.
1	satin nickel	Zinc	133.53.093	\$140.86
2	gold champagne	Zinc	133.53.090	\$140.86
3	black bronzed	Zinc	133.53.083	\$140.86
4	polished nickel	Zinc	133.53.092	\$140.86

Note
Supplied with mounting screws. Refer to pages 91–94 for matching handles and knobs.

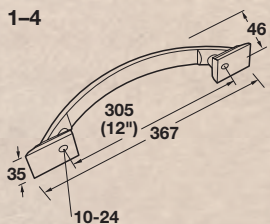

Dimensions in mm unless otherwise noted. Prices subject to change.



Westerly

BY AMEROCK

	Finish	Material	Item No.	SRP/pc.
1	polished nickel	Zinc	133.53.227	\$176.06
2	satin nickel	Zinc	133.53.228	\$176.06
3	gold champagne	Zinc	133.53.222	\$176.06
4	black bronzed	Zinc	133.53.217	\$176.06

Note

Supplied with mounting screws. Refer to pages 99–100 for matching handles and knobs.

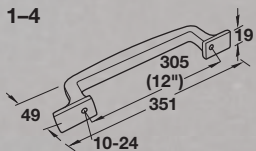



Highland Ridge

BY AMEROCK

	Finish	Material	Item No.	SRP/pc.
1	black bronzed	Zinc	133.53.150	\$246.48
2	satin nickel	Zinc	133.53.174	\$246.48
3	polished nickel	Zinc	133.53.166	\$246.48
4	gold champagne	Zinc	133.53.158	\$246.48

Note

Supplied with mounting screws. Refer to pages 200–202 for matching handles and knobs.

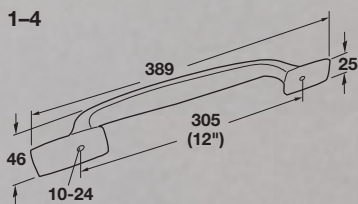

Dimensions in mm unless otherwise noted. Prices subject to change.



Bar Pulls

BY AMEROCK

	Finish	Material	Item No.	SRP/pc.
1	gunmetal	Steel	133.50.655	\$159.77
2	gold champagne	Steel	133.53.055	\$177.48
3	polished nickel	Steel	133.50.656	\$177.50
4	black bronzed	Steel	133.53.054	\$177.48

Note

Supplied with mounting screws. Refer to page 139–142 for matching handles and knobs.

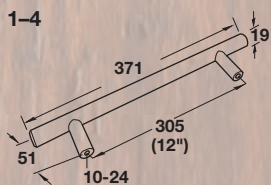

HOOKS

Functional. But with style. Stylish, but decorative too. The range of hooks offered by Häfele includes a wide variety of finishes, styles and capabilities. There's your simple hat and coat hook as well as your more chic hat and coat hook. And then there's a range of decorative hooks which make a statement, but also serve as a sturdy place for your things – all while complementing to your designs. Whether it's one hook that's needed for a specific purpose or place or many to add storage capability throughout a space, we've got you many places for you to hang your hat, scarf, jacket, keys or anything else.

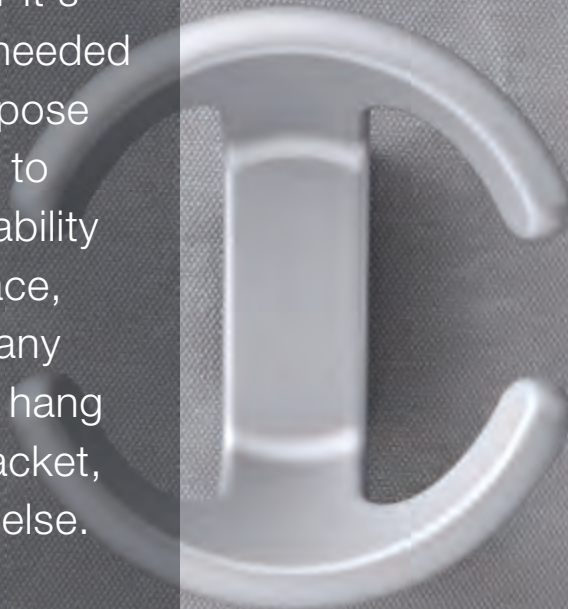
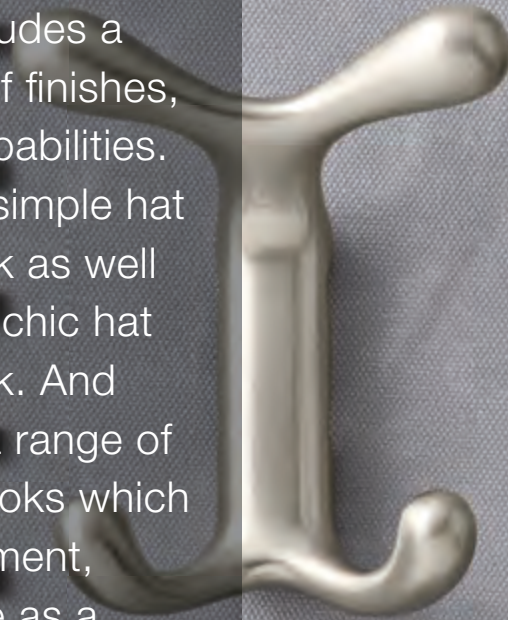

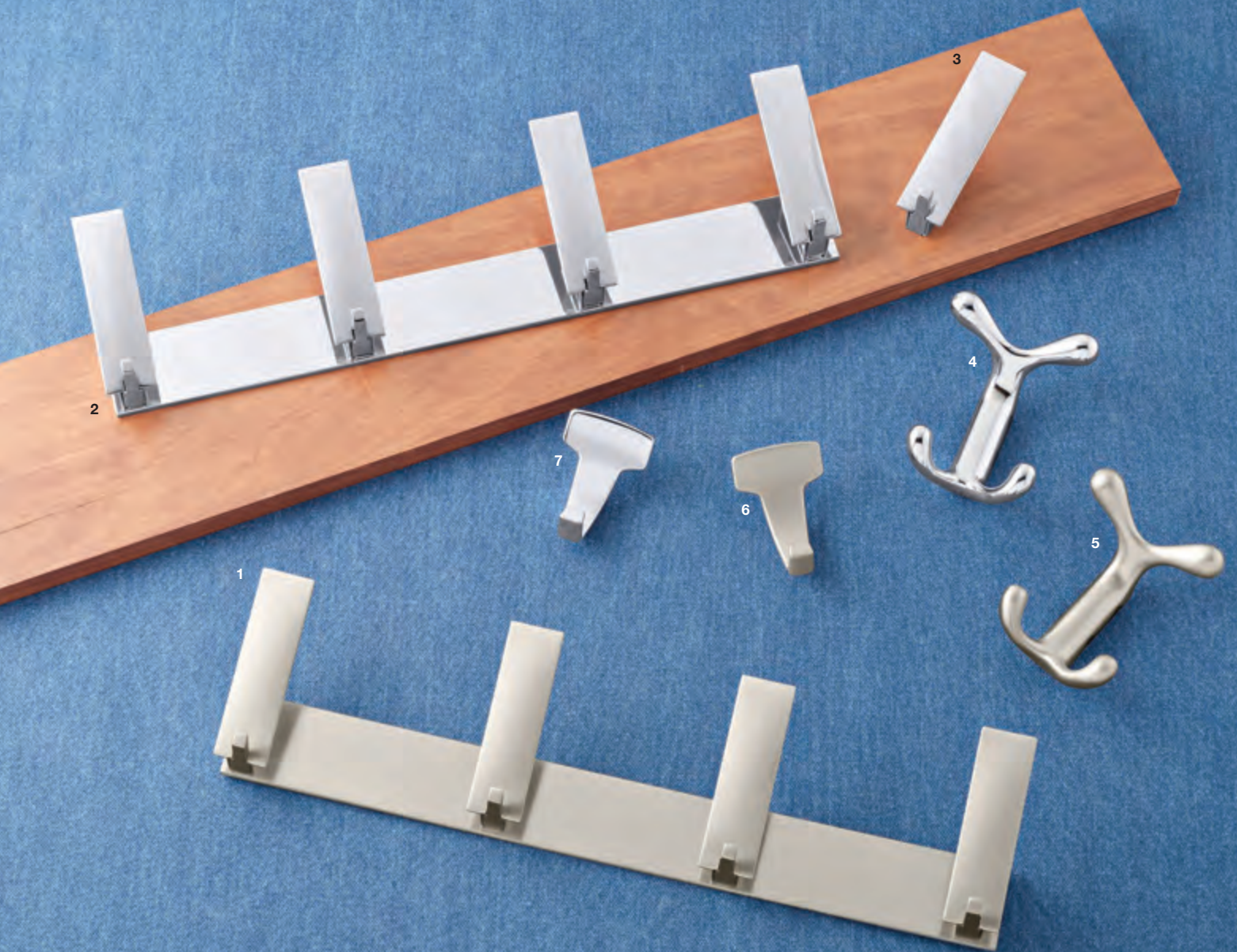

Hooks

	Finish	Material	Item No.	SRP/pc.
1	stainless steel look	Zinc	844.69.630	\$384.70
2	polished chrome	Zinc	844.69.230	\$355.00
3	polished chrome	Zinc	844.69.220	\$87.16
4	polished chrome	Zinc	843.81.200	\$61.26
5	satin nickel	Zinc	843.81.600	\$69.98
6	satin nickel	Zinc	844.69.640	\$60.48
7	polished chrome	Zinc	844.69.240	\$53.48

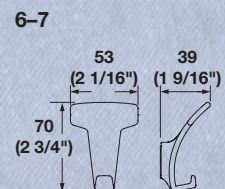
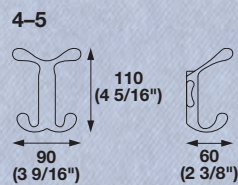
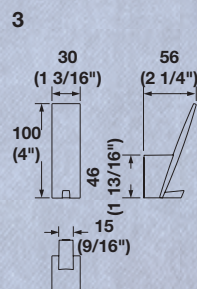
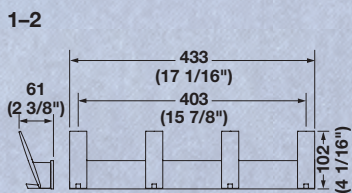



Hooks

	Finish	Material	Item No.	SRP/pc.
1	matt nickel	Zinc	843.65.600	\$57.86
2	matt aluminum	Zinc	843.65.900	\$57.68
3	satin nickel	Zinc	843.77.000	\$127.52
4	matt aluminum	Zinc	843.77.900	\$80.56
5	polished chrome	Zinc	843.77.200	\$110.08
6	satin nickel	Zinc	843.63.050	\$101.78

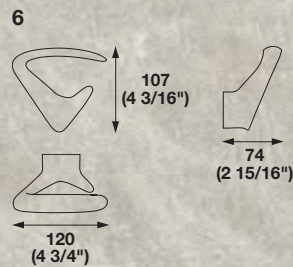
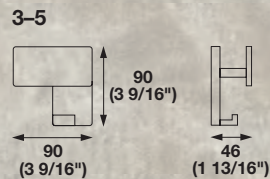
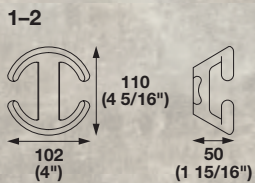



Hooks

Finish

- 1 dark oil-rubbed bronze
- 2 polished chrome
- 3 matt nickel
- 4 polished chrome
- 5 matt nickel
- 6 dark oil-rubbed bronze

Material

- Zinc
- Zinc
- Zinc
- Zinc
- Zinc
- Zinc

Item No.

- 845.08.120
- 845.08.220
- 845.08.620
- 845.05.200
- 845.05.600
- 845.05.300

SRP/pc.

- \$16.81
- \$16.81
- \$17.93
- \$5.29
- \$4.99
- \$4.60

1-3

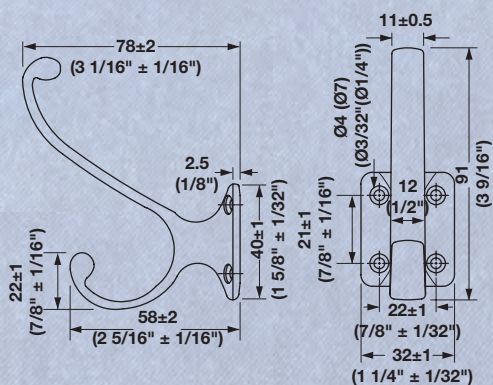

4-6

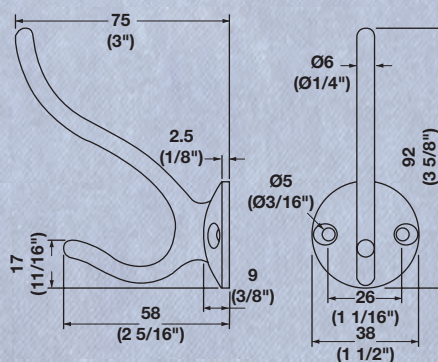



Hooks

	Finish	Material	W x D x H	Item No.	SRP/pc.
1	dark oil-rubbed bronze	Zinc	18 x 55 x 90 (11/16" x 2 1/16" x 3 9/16")	845.01.300	\$2.50
2	chrome polished	Zinc	18 x 55 x 90 (11/16" x 2 1/16" x 3 9/16")	885.06.209	\$2.58
3	matt nickel	Zinc	18 x 55 x 90 (11/16" x 2 1/16" x 3 9/16")	845.01.600	\$3.58
4	matt nickel	Zinc	18 x 40 x 40 (11/16" x 1 9/16" x 1 9/16")	845.01.620*	\$3.56
5	polished	Aluminum	22 x 32 x 40 (7/8" x 1 1/4" x 1 9/16")	845.02.803	\$2.40
6	polished	Aluminum	19 x 28 x 38 (3/4" x 1 1/8" x 1 1/2")	845.01.806	\$1.95
7	polished	Aluminum	13 x 22 x 30 (1/2" x 7/8" x 1 1/4")	845.00.809	\$1.53
8	polished	Aluminum	63 x 30 x 50 (2 1/2" x 1 3/16" x 2")	845.12.809	\$2.34
9	polished	Aluminum	50 x 25 x 40 (2" x 1" x 1 9/16")	845.11.802	\$1.85
10	polished	Aluminum	42 x 22 x 32 (1 11/16" x 7/8" x 1 1/4")	845.10.805	\$1.37

Note

*Supplied with screws.



Hooks

	Finish	Material	Item No.	SRP/pc.
1-2	1 matt black 2 matt gold	Zinc Zinc	845.01.340 845.01.540	\$2.93 \$2.86
3-4	3 matt black 4 matt gold	Zinc Zinc	845.05.430 845.05.730	\$3.28 \$3.76

1-2

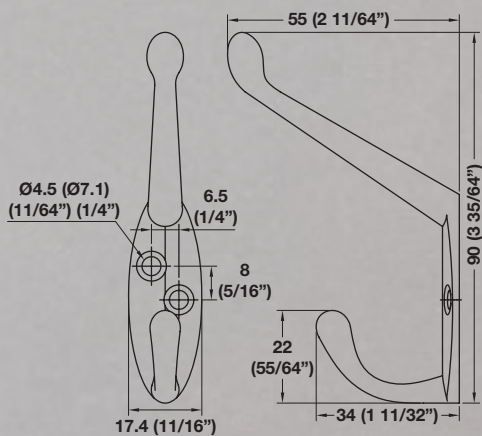

3-4

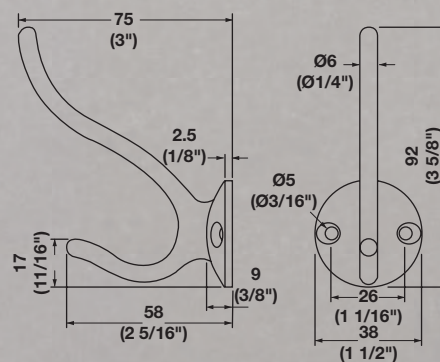



Hooks

	Finish	Material	W x D x H	CTC	Item No.	SRP/pc.
1	matt	Stainless Steel	25 x 52 x 110 (1" x 2" x 4 3/8")	20 (7/8")	842.34.010*	\$100.62
2	matt	Stainless Steel	20 x 72 x 150 (7/8" x 2 7/8" x 6")	20 (7/8")	842.34.000*	\$70.48
3	matt silver	Aluminum	18 x 93 x 158 (11/16" x 3 11/16" x 6 5/8")	20 (7/8")	842.02.906	\$6.84
4	matt silver	Aluminum	18 x 35 x 60 (11/16" x 1 3/8" x 2 7/16")	20 (7/8")	842.01.909	\$4.65
5	matt	Stainless Steel	20 x 40 x 60 (7/8" x 1 1/2" x 2 3/8")	20 (7/8")	842.34.050*	\$55.56

Note

*Supplied with mounting hardware

Modified Truss Head Screws with Combi Cross/slot Drive

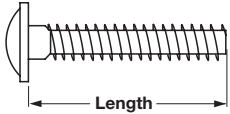

Screw, M4

With combi cross/slot drive.
Material: Steel; Finish: zinc-plated

Length	Item No.	Packing	SRP/pkg.	Item No.	Bulk	SRP/pkg.
M4 x 10 (13/32")	022.35.109	100 pcs.	\$9.58	022.45.109	1,000 pcs.	\$62.60
M4 x 12 (1/2")	022.35.127	100 pcs.	\$10.06	022.45.127	1,000 pcs.	\$65.30
M4 x 15 (5/8")	022.35.154	100 pcs.	\$10.49	022.45.154	1,000 pcs.	\$66.50
M4 x 18 (11/16")	022.35.181	100 pcs.	\$11.26	022.45.181	1,000 pcs.	\$76.30
M4 x 20 (13/16")	022.35.207	100 pcs.	\$11.42	022.45.207	1,000 pcs.	\$76.30
M4 x 22 (7/8")	022.35.225	100 pcs.	\$11.88	022.45.225	1,000 pcs.	\$81.10
M4 x 23 (15/16")	022.35.234	100 pcs.	\$12.34	022.45.234	1,000 pcs.	\$84.70
M4 x 25 (1")	022.35.252	100 pcs.	\$13.80	022.35.253	1,000 pcs.	\$83.50

Screw, 8-32

With combi cross/slot drive.
Material: Steel; Finish: yellow zinc

Length	Item No.	Packing	SRP/pkg.	Item No.	Bulk	SRP/pkg.
8-32 x 10 (13/32")	-	-	-	022.25.100	1,000 pcs.	\$63.80
8-32 x 15 (5/8")	022.24.150	100 pcs.	\$8.95	022.25.150	1,000 pcs.	\$65.80
8-32 x 20 (13/16")	022.24.200	100 pcs.	\$10.03	022.25.200	1,000 pcs.	\$79.00
8-32 x 25 (1")	022.24.256	100 pcs.	\$11.06	022.25.256	500 pcs.	\$43.45
8-32 x 25 (1")	-	-	-	022.25.258	5,000 pcs.	\$354.00
8-32 x 38 (1 1/2")	022.24.381	100 pcs.	\$16.80	022.25.381	500 pcs.	\$58.20
8-32 x 45 (1 3/4")	022.24.452	100 pcs.	\$21.07	022.25.452	500 pcs.	\$72.50
8-32 x 45 (1 3/4")	-	-	-	022.25.454	3,000 pcs.	\$297.30
8-32 x 75 (3")	022.24.750	100 pcs.	\$24.60	-	-	-

Screw, 8-32

With combi cross/slot drive.
Material: Steel; Finish: zinc-plated

Length	Item No.	Packing	SRP/pkg.	Item No.	Bulk	SRP/pkg.
8-32 x 22 (7/8")	022.24.229	100 pcs.	\$10.44	022.25.229	1,000 pcs.	\$124.30
8-32 x 32 (1 1/4")	022.24.327	100 pcs.	\$13.66	022.25.327	500 pcs.	\$63.35
8-32 x 35 (1 3/8")	022.25.350	100 pcs.	\$15.26	-	-	-
8-32 x 42 (1 21/32")	022.24.410	100 pcs.	\$18.00	022.25.410	500 pcs.	\$80.05
8-32 x 48 (1 7/8")	022.24.470	100 pcs.	\$19.13	-	-	-
8-32 x 51 (2")	022.24.500	100 pcs.	\$18.74	-	-	-

Modified Truss Head Screws with Combi Cross/slot Drive



Screw, M4

With combi cross/slot drive.

Install with a #2 Pozi drive or #2 Phillips screwdriver.

Material: Steel; Finish: nickel-plated

Length	Item No.	Packing	SRP/pkg.	Item No.	Bulk	SRP/pkg.
M4 x 15 (5/8")	022.34.157	100 pcs.	\$12.48	022.44.157	1,000 pcs.	\$79.90
M4 x 25 (1")	022.34.255	100 pcs.	\$14.90	022.44.255	1,000 pcs.	\$109.40

Screw, M4

With combi cross/slot drive.

Install with a #2 Pozi drive or #2 Phillips screwdriver.

Material: Steel; Finish: zinc-plated

Length	Item No.	Packing	SRP/pkg.	Item No.	Bulk	SRP/pkg.
M4 x 28 (1 1/8")	022.35.289	100 pcs.	\$13.87	022.45.289	500 pcs.	\$49.30
M4 x 30 (1 3/16")	022.35.305	100 pcs.	\$14.30	022.45.305	500 pcs.	\$49.10
M4 x 35 (1 3/8")	022.35.350	100 pcs.	\$15.41	022.45.350	500 pcs.	\$52.90
M4 x 38 (1 1/2")	022.35.387	100 pcs.	\$16.78	022.45.387	500 pcs.	\$55.80
M4 x 40 (1 9/16")	022.35.403	100 pcs.	\$17.74	022.45.403	500 pcs.	\$59.05
M4 x 45 (1 3/4")	022.35.458	100 pcs.	\$20.93	022.35.457	500 pcs.	\$89.30
M4 x 45 (1 3/4")	–	–	–	022.45.458	3,000 pcs.	\$398.10
M4 x 50 (2")	022.35.501	100 pcs.	\$16.58	022.45.501	500 pcs.	\$76.80
M4 x 60 (2 3/8")	–	–	–	022.45.609	500 pcs.	\$92.75
M4 x 70 (2 3/4")	022.35.700	100 pcs.	\$41.09	022.45.700	300 pcs.	\$65.16
M4 x 75 (3")	022.35.750	100 pcs.	\$29.88	–	–	–

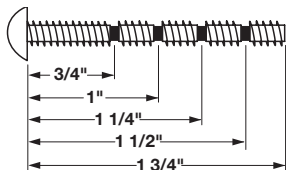

Screw, 8-32, cut off

Install with a #2 Phillips screwdriver

Cut to length by using wire snips

Length options: 19–45 mm (3/4"–1 3/4")

Material: Steel; Finish: yellow zinc

Length	Item No.	Packing	SRP/pkg.	Item No.	Bulk	SRP/pkg.
8-32 x 19–45 (3/4"–1 3/4")	022.24.881	100 pcs.	\$21.84	022.25.881	500 pcs.	\$76.20

Screw, M4, cut off

Install with a #2 Phillips screwdriver

Cut to length by using wire snips

Length options: 19–45 mm (3/4"–1 3/4")

Material: Steel; Finish: zinc-plated

Length	Item No.	Packing	SRP/pkg.	Item No.	Bulk	SRP/pkg.
M4 x 19–45 (3/4"–1 3/4")	022.35.887	100 pcs.	\$20.62	022.45.887	500 pcs.	\$73.90

Large Pan Head Screws and Hangar Bolts

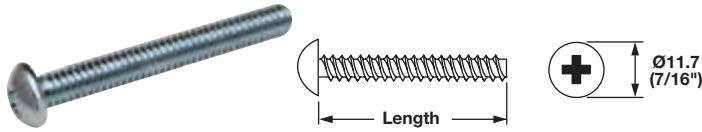

Screw, M6
With #2 Phillips Drive.
Material: Steel; Finish: zinc-plated

Length	Item No.	SRP/pkg.
M6 x 20 (13/16")	020.43.271	\$11.86
M6 x 25 (1")	020.43.272	\$30.48
M6 x 30 (1 3/16")	020.43.273	\$14.74
M6 x 40 (1 9/16")	020.43.275	\$20.04
M6 x 45 (1 3/4")	020.43.276	\$23.33
M6 x 50 (2")	020.43.277	\$24.55

Supplied With
50 pcs.

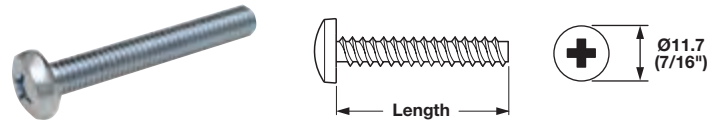

Screw, 1/4-20
With #2 Phillips Drive.
Material: Steel; Finish: zinc-plated

Length	Item No.	SRP/pkg.
1/4-20 x 3/4"	020.42.271	\$12.19
1/4-20 x 1"	020.42.272	\$11.50
1/4-20 x 1 1/4"	020.42.273	\$14.74
1/4-20 x 1 1/2"	020.42.275	\$16.44
1/4-20 x 2 1/2"	020.42.280	\$30.54
1/4-20 x 3"	020.42.282	\$32.73

Supplied With
50 pcs.

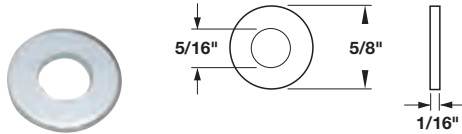

Washer
For decorative screws.
Material: Steel

Finish	Item No.	SRP/pkg.
zinc-plated	037.05.934	\$3.77

Supplied With
50 pcs.

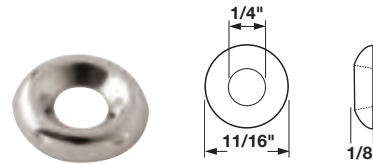

Cup Washer
Used when hanging cabinets to keep screw head from pulling through panel.
For #12 Countersunk Screws.
Material: Steel

Finish	Item No.	SRP/pkg.
nickel-plated	045.17.760	\$148.80

Supplied With
1000 pcs.

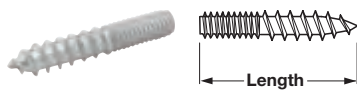

Hangar Bolt
Length: 25 mm (1").
Material: Steel

Version	Finish	Item No.	Packing	SRP/pkg.	Item No.	Bulk	SRP/pkg.
M4	zinc-plated	026.11.902	100 pcs.	\$4.34	026.11.922	1,000 pcs.	\$50.40
8-32	yellow chromate	026.11.942	100 pcs.	\$5.02	026.11.962	1,000 pcs.	\$50.60
M8	yellow chromate	026.12.944	100 pcs.	\$224.57	-	-	-

Jigs



Cabinet Hardware Jig

With shelf pin and long handle attachment.
Material: Aluminum

Color
black

Item No. 001.35.051
SRP/pc. \$770.83



Shelf Pin/Long Handle Attachment

Converts 001.35.050 to 001.35.051
Material: Aluminum

Color
black

Item No. 001.35.059
SRP/pc. \$325.87

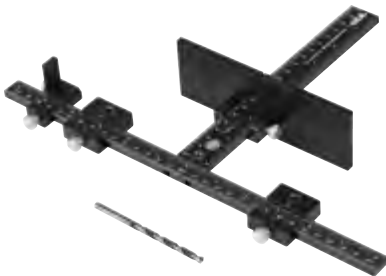

Cabinet Hardware Jig

Material: Aluminum

Color
black

Item No. 001.35.050
SRP/pc. \$595.46



Handle Drilling Jig

For exact drilling of holes for handles with standard hole distance
96–320 mm (3 13/16"–12 19/32").
Material: Plexiglass, clear and Aluminum

Item No.

001.35.040

SRP/pc.

\$240.00

Note

Not suitable for profiles and inset handles. Must be used with Ø5 mm drill bit.

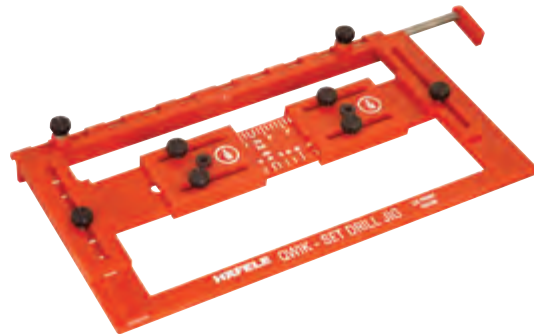

Quick-Set Drilling Jig for Handles

For precise drilling and positioning of handles on doors, flaps and drawer fronts.

Convertible side stop, can be used horizontally and vertically

Drilling bushings: for drilling Ø4.3–4.6 mm (1 1/64"–3/16")

Drill hole spacing: adjustable from 64–143 mm (2 1/2"–5 5/8")

Distance from edge: adjustable from 26–103 mm (1 1/16"–4 1/16")

Material: Plastic with hardened drilling bushings

Color

red

Item No.

001.31.233

SRP/pc.

\$83.45



Euro Handle-It for Pulls and Handles

For pulls on doors or drawer fronts.

Ideal for small to medium size shops.

With metric and inch scale.

Use a 4.5 mm or 3/16" drill.

Material: Polycarbonate with hardened steel bushings; Color: black

Description

Jig

Item No.

001.35.001

SRP/pc.

\$122.02

Repair kit

001.35.020

\$29.81

Mid-Century Modern



3 NEW



8



11



16 NEW



3 NEW



8



11



16 NEW



3 NEW



8



11



16 NEW



3 NEW



8



11



16 NEW



4 NEW



8



12



4-5 NEW



8



12



4-5 NEW



9



13-14



6



9



13-14



6



10



13-14



6



10



13-14



7



10



15



7



10



15



8



10



15

Modern

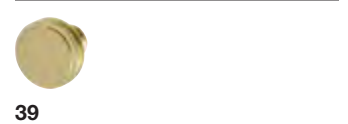

Urban



43 **NEW**



48



51-52



57-58 **NEW**



43 **NEW**



48



53



57-58 **NEW**



43 **NEW**



48



53



59-61



44 **NEW**



49



53



59-61



45 **NEW**



49



54



59-61



45 **NEW**



49



54



59-61



45 **NEW**



49



54



59-61



46



50



54



62



46



50



54



62



47



50



55



62



47



51-52



55



62



47



51-52



55



47



51-52



56



47



51-52



57-58 **NEW**

Art Deco/Glam



65 **NEW**



69-70



75-76



82-84



65 **NEW**



69-70



75-76



82-84



65-66 **NEW**



69-70



75-76



82-84



65-66 **NEW**



71



75-76



82-84



65-66 **NEW**



71



77-78



82-84



65-66 **NEW**



71



77-78



85



65-66 **NEW**



71



77-78



85



67



72



78



86



67



72



79-80



86



67



72



79-80



68



73-74



79-80



68



73-74



79-80



68



73-74



81



69-70



73-74



81

Transitional

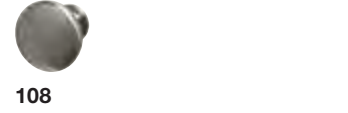

Contemporary



111 **NEW**



117



122



128



111 **NEW**



117



123



129-130



112 **NEW**



118



123



129-130



112 **NEW**



119



123



131



113



119



123



131



113



119



124



131



113



120



124



131



114



120



125



132



114



120



126



132



114



120



126



132



114



121



127



133



115-116



122



127



134



116



122



127



134



116



122









































128









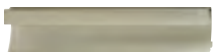

134

Contemporary

 134	 137 NEW	 145-147 NEW	 153-154 NEW
 135	 139-142	 148-150 NEW	 153 NEW
 135	 139-142	 148-150 NEW	 155-156 NEW
 135	 139-142	 148-150 NEW	 155-156 NEW
 135	 143	 149 NEW	 155-156 NEW
 136	 144 NEW	 151-152 NEW	 155-156 NEW
 136	 144 NEW	 151-152 NEW	 157-158 NEW
 136	 145 NEW	 151-152 NEW	 157-158 NEW
 137-138 NEW	 145-147 NEW	 153-154 NEW	 157-158 NEW
 137-138 NEW	 145-147 NEW	 153-154 NEW	

Minimalist

 161	 162	 163-164	 168-169
 161	 163-164	 166	
 162	 163-164	 167	

Minimalist



168-169



171 **NEW**



171



171



172



173-179 **NEW**



173-179 **NEW**



173-179 **NEW**



173-179 **NEW**



180 **NEW**



180 **NEW**



180 **NEW**

Architectural



183



183



184



184



184



185



185



185



185



185



185



185



186



186



187



187



187



187



188



188



188



189-190 **NEW**

Farmhouse



193-194



195



198-199



200-202



193-194

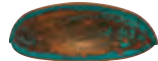

196



198-199



203



193-194



196



198-199



203



193-194



196



200-202



204



193-194



197



200-202



204



193-194



197



200-202



195



198-199



200-202



195



198-199



200-202

Coastal



207



208



209



210



207



208



209-210



210



207



208



209-210



208













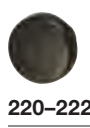
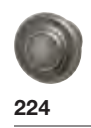

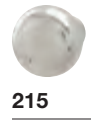
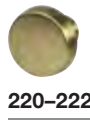
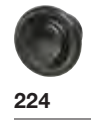

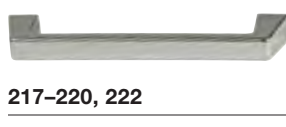

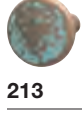



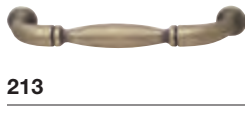

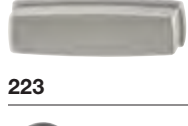



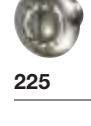

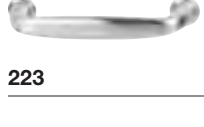
208

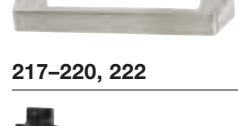

209-210

Rustic

 213	 215	 220-222	 224
 213	 215	 220-222	 224
 213	 216	 217-220, 222	 225
 213	 216	 223	 225
 213	 217, 221	 223	 225
 214	 217, 221	 223	 225
 214	 217-220, 222	 223	 226
 214	 217-220, 222	 224	 226
 214	 219, 221-222	 224	

Revival

 229	 230-232	 230-232	 233-234
 229	 230-232	 230-232	 233-234
 229	 230-232	 233-234	 233-234

Classic

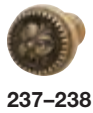

237-238



241



244



248-250 **NEW**



237-238

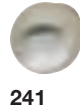

241



244



251-252 **NEW**



237-238



241



244



251-252 **NEW**



237-238



241



245-246



251-252 **NEW**



239

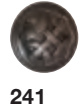

241



245-246



251-252 **NEW**



239



241



245-246



239



241



245-246



239



242



247



240



242

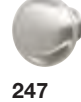

247



240



242



247



240



243



248 **NEW**



240



243

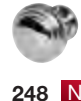

248 **NEW**



240



243



248-250 **NEW**



241



243



248-250 **NEW**

Appliance Pulls



255 **NEW**



259



263



267



256



259



264



268



257



260 **NEW**



264



269



257



260 **NEW**



265



258



261 **NEW**



265



258



262



266

Hooks



271



272



274



276



271



272



274



276



271



273



275



271



273



275



272



274



276

Index

Item No.	Page	Item No.	Page	Item No.	Page	Item No.	Page	Item No.	Page
001.31.233	280	022.45.403	278	103.05.620	195	106.04.074	179	106.70.000	46
001.35.001	280	022.45.458	278	103.06.300	196	106.04.080	178	106.70.003	46
001.35.020	280	022.45.501	278	103.06.600	196	106.04.081	178	106.70.005	46
001.35.040	280	022.45.609	278	103.06.700	196	106.04.082	178	106.70.011	46
001.35.050	280	022.45.700	278	103.29.711	71	106.04.083	178	106.70.013	46
001.35.051	280	022.45.887	278	103.29.712	71	106.04.084	178	106.70.030	23
001.35.059	280	026.11.902	279	103.30.105	4	106.04.090	177	106.70.031	23
020.42.271	279	026.11.922	279	103.30.106	4	106.04.091	177	106.70.032	23
020.42.272	279	026.11.942	279	103.30.205	4	106.04.092	177	106.70.040	23
020.42.273	279	026.11.962	279	103.30.206	4	106.04.093	177	106.70.041	23
020.42.275	279	026.12.944	279	103.30.705	5	106.04.094	177	106.70.042	23
020.42.280	279	037.05.934	279	103.30.706	5	106.04.100	176	106.70.071	23
020.42.282	279	045.17.760	279	103.30.805	5	106.04.101	176	106.70.072	23
020.43.271	279	100.51.025	188	103.30.806	5	106.04.102	176	106.70.081	23
020.43.272	279	100.61.625	198	103.78.026	90	106.04.103	176	106.70.082	23
020.43.273	279	100.61.626	199	103.79.401	72	106.04.104	176	106.70.090	43
020.43.275	279	100.61.627	198	103.79.411	72	106.04.110	175	106.70.091	43
020.43.276	279	100.61.656	258	103.84.632	126	106.04.111	175	106.70.100	89
020.43.277	279	100.61.676	258	103.89.901	56	106.04.112	175	106.70.101	89
022.24.150	277	100.61.704	198	103.89.902	56	106.04.113	175	106.70.102	89
022.24.200	277	100.61.705	199	103.89.903	56	106.04.114	175	106.70.106	89
022.24.229	277	100.61.707	198	103.89.904	56	106.04.120	174	106.70.107	89
022.24.256	277	100.61.717	258	103.89.905	56	106.04.121	174	106.70.108	89
022.24.327	277	101.20.751	133	103.89.913	56	106.04.122	174	106.70.109	89
022.24.381	277	101.20.752	133	104.09.600	208	106.04.123	174	106.70.110	89
022.24.410	277	101.20.753	133	104.33.200	7	106.04.124	174	106.70.111	89
022.24.452	277	101.20.754	133	104.33.330	7	106.04.130	173	106.70.120	89
022.24.470	277	101.20.755	133	104.33.600	7	106.04.131	173	106.70.122	89
022.24.500	277	101.20.756	133	104.35.310	135	106.04.132	173	106.70.123	89
022.24.750	277	101.20.757	133	104.35.600	90	106.04.133	173	106.70.130	3
022.24.881	278	101.20.758	133	104.37.600	90	106.04.134	173	106.70.131	3
022.25.100	277	101.69.504	19	104.66.200	10	106.09.601	28	106.70.135	3
022.25.150	277	101.69.505	19	104.66.300	10	106.11.904	171	106.70.136	3
022.25.200	277	101.69.510	19	104.66.600	10	106.34.643	47	106.70.150	65
022.25.229	277	101.69.511	19	104.80.002	8	106.59.210	186	106.70.151	65
022.25.256	277	101.80.603	47	104.80.600	8	106.59.410	186	106.70.152	65
022.25.258	277	102.36.600	132	104.96.251	208	106.61.043	7	106.70.153	255
022.25.327	277	102.47.300	16	104.96.252	208	106.61.044	7	106.70.160	66
022.25.350	277	102.47.301	16	104.96.651	208	106.65.346	50	106.70.161	66
022.25.381	277	102.47.302	16	104.96.652	208	106.65.350	50	106.70.162	66
022.25.410	277	102.47.303	16	105.26.600	11	106.65.646	50	106.70.163	255
022.25.452	277	102.47.319	114	105.34.602	28	106.65.650	50	106.70.171	65
022.25.454	277	102.47.320	34	105.43.300	50	106.69.010	19	106.70.172	66
022.25.881	278	102.47.321	34	105.43.400	50	106.69.011	19	106.70.173	66
022.34.157	278	102.47.322	34	105.49.620	8	106.69.020	44	106.70.175	65
022.34.255	278	102.47.323	34	105.61.014	196	106.69.022	44	106.70.180	65
022.35.109	277	102.47.330	34	105.61.300	196	106.69.030	45	106.70.185	43
022.35.127	277	102.47.331	34	105.61.600	196	106.69.032	45	106.70.186	43
022.35.154	277	102.47.332	34	105.63.300	15	106.69.100	3	106.70.200	43
022.35.181	277	102.47.333	34	105.63.600	15	106.69.101	3	106.70.201	43
022.35.207	277	102.47.340	34	106.04.000	180	106.69.102	3	106.70.202	43
022.35.225	277	102.47.341	34	106.04.001	180	106.69.110	44	106.70.212	43
022.35.234	277	102.47.342	34	106.04.002	180	106.69.111	44	106.70.220	66
022.35.252	277	102.47.343	34	106.04.003	180	106.69.120	45	106.70.221	66
022.35.253	277	102.47.350	33	106.04.010	180	106.69.121	45	106.70.222	66
022.35.289	278	102.47.351	33	106.04.011	180	106.69.140	45	106.70.223	255
022.35.305	278	102.47.352	33	106.04.012	180	106.69.141	45	106.74.602	131
022.35.350	278	102.47.353	33	106.04.013	180	106.69.150	45	106.74.613	131
022.35.387	278	102.47.360	33	106.04.020	57	106.69.152	45	107.04.602	90
022.35.403	278	102.47.361	33	106.04.021	57	106.69.162	44	107.13.112	241
022.35.457	278	102.47.362	33	106.04.022	57	106.69.163	44	107.20.303	134
022.35.458	278	102.47.363	33	106.04.030	58	106.69.170	19	107.20.603	134
022.35.501	278	102.47.370	260	106.04.031	58	106.69.171	19	107.40.902	8
022.35.700	278	102.47.371	260	106.04.032	58	106.69.190	19	107.96.233	207
022.35.750	278	102.47.372	260	106.04.040	58	106.69.191	19	107.96.234	207
022.35.887	278	102.47.373	260	106.04.041	58	106.69.205	24	107.96.238	207
022.44.157	278	102.47.380	260	106.04.042	58	106.69.207	24	108.57.111	49
022.44.255	278	102.47.381	260	106.04.050	57	106.69.276	113	108.76.231	13
022.45.109	277	102.47.382	260	106.04.051	57	106.69.277	113	108.76.232	13
022.45.127	277	102.47.383	260	106.04.052	57	106.69.280	28	108.76.233	13
022.45.154	277	102.47.390	35	106.04.060	179	106.69.320	3	108.76.240	13
022.45.181	277	102.47.391	35	106.04.061	179	106.69.321	3	108.76.241	14
022.45.207	277	102.47.392	35	106.04.062	179	106.69.322	3	108.76.245	13
022.45.225	277	102.47.393	35	106.04.063	179	106.69.501	8	108.76.246	14
022.45.234	277	102.64.100	67	106.04.064	179	106.69.502	8	108.76.250	13
022.45.289	278	102.64.600	67	106.04.070	179	106.69.605	24	108.76.251	14
022.45.305	278	102.64.700	67	106.04.071	179	106.69.607	24	108.76.731	14
022.45.350	278	102.71.959	15	106.04.072	179	106.69.676	113	108.76.732	14
022.45.387	278	102.81.320	15	106.04.073	179	106.69.677	113	108.76.733	14

Index

Item No.	Page	Item No.	Page	Item No.	Page	Item No.	Page	Item No.	Page
108.78.013	12	110.52.461	137	116.07.018	136	118.68.204	4	125.87.932	238
108.78.017	12	110.52.462	137	116.07.024	136	118.68.704	5	125.87.952	238
108.78.213	12	110.52.470	138	116.07.027	136	118.68.804	5	125.88.311	239
108.78.217	12	110.52.471	138	116.07.043	136	118.94.310	213	125.88.312	239
108.94.223	32	110.52.472	138	116.07.118	127	118.95.310	213	125.88.314	239
108.94.228	32	110.52.480	138	116.07.217	127	120.17.370	240	125.88.315	257
108.94.901	30	110.52.481	138	116.07.224	127	120.61.350	122	125.88.343	239
108.94.903	30	110.52.482	138	116.07.227	127	120.62.110	241	125.88.355	239
108.94.904	30	110.93.161	214	116.07.323	136	120.70.303	240	125.88.901	239
108.94.905	30	110.93.162	214	116.07.333	136	121.46.350	243	125.88.902	239
108.94.906	30	110.93.191	241	116.07.417	127	121.88.260	240	125.88.904	239
108.94.907	30	110.93.192	241	116.07.418	124	121.88.662	240	125.88.905	257
108.94.923	32	110.93.361	214	116.07.423	128	121.88.868	240	125.88.942	239
109.50.205	131	110.93.362	214	116.07.424	127	121.90.301	242	125.88.951	239
109.50.274	207	110.93.461	214	116.07.426	128	121.90.302	242	126.14.605	29
109.57.602	8	110.93.462	214	116.07.427	124	121.90.902	242	126.14.608	29
109.60.602	113	110.93.661	214	116.07.443	122	122.18.129	240	126.19.900	171
109.60.603	113	110.93.662	214	116.07.444	122	123.02.600	194	126.35.925	172
109.60.605	113	110.93.961	214	116.07.627	128	123.02.631	198	126.36.001	167
109.60.625	113	110.93.962	214	116.07.631	126	123.02.632	198	126.36.300	167
109.80.401	8	111.24.605	32	116.07.664	132	123.02.651	199	126.36.700	167
110.20.603	114	111.25.252	71	116.07.700	35	123.02.653	199	126.36.900	167
110.22.001	120	111.25.262	71	116.07.701	35	123.02.670	193	126.37.001	167
110.22.050	9	111.59.002	49	116.09.324	136	123.02.700	193	126.37.070	170
110.22.080	9	111.59.624	32	116.09.340	132	123.02.710	193	126.37.071	170
110.22.081	9	111.59.625	32	116.11.635	187	123.02.721	198	126.37.074	170
110.22.082	9	111.93.286	32	116.11.644	187	123.02.722	198	126.37.075	170
110.22.086	9	111.93.686	32	116.11.662	187	123.08.141	67	126.37.096	170
110.22.089	9	112.81.273	32	116.11.671	187	123.08.142	67	126.37.097	170
110.22.201	186	112.81.278	32	116.22.236	134	123.08.143	67	126.37.098	170
110.22.202	186	112.82.003	31	116.22.316	49	123.08.144	256	126.37.113	168
110.29.256	111	112.82.004	31	116.22.334	123	123.08.441	67	126.37.123	168
110.29.259	111	112.82.007	31	116.22.343	123	123.08.442	67	126.37.300	167
110.29.260	111	112.82.010	31	116.22.610	47	123.08.443	67	126.37.312	169
110.29.261	111	112.82.903	31	116.22.638	123	123.08.444	256	126.37.322	169
110.29.356	112	112.82.904	31	116.22.647	123	123.08.602	90	126.37.370	170
110.29.358	112	112.82.907	31	116.22.736	208	123.08.610	90	126.37.371	170
110.29.656	112	112.82.910	31	116.22.745	208	123.08.631	90	126.37.374	170
110.29.659	112	112.83.000	129	116.35.665	194	123.08.641	90	126.37.375	170
110.34.216	114	112.83.002	130	116.36.206	258	123.08.746	67	126.37.700	167
110.34.227	6	112.83.003	129	116.36.606	258	123.08.747	67	126.37.712	168
110.34.255	6	112.83.004	130	116.36.616	258	123.08.748	67	126.37.722	168
110.34.265	48	112.83.006	129	116.39.259	134	123.08.749	256	126.37.770	170
110.34.266	48	112.83.009	130	116.39.464	122	123.27.032	213	126.37.771	170
110.34.271	47	112.83.010	129	116.39.553	135	123.31.031	213	126.37.774	170
110.34.274	47	112.83.015	130	116.60.200	53	124.40.053	54	126.37.775	170
110.34.286	68	112.83.900	130	116.60.201	53	125.16.101	240	126.37.900	167
110.34.287	68	112.83.902	129	116.61.000	216	125.28.100	241	126.37.912	169
110.34.306	24	112.83.903	130	116.61.002	216	125.61.051	243	126.37.922	169
110.34.307	24	112.83.904	129	116.61.007	259	125.61.100	213	126.37.936	170
110.34.327	6	112.83.906	130	116.61.008	259	125.61.251	243	126.37.937	170
110.34.355	6	112.83.909	129	116.61.100	216	125.61.351	243	126.37.938	170
110.34.606	24	112.83.910	130	116.61.102	216	125.67.351	229	126.37.976	170
110.34.607	24	112.83.911	129	116.61.107	259	125.67.352	229	126.37.977	170
110.34.616	114	113.96.237	120	116.61.108	259	125.72.102	241	126.37.978	170
110.34.627	6	113.97.010	55	116.61.920	216	125.73.113	241	126.37.980	170
110.34.655	6	113.97.024	55	116.61.921	216	125.82.100	215	126.37.981	170
110.34.665	48	113.97.027	55	116.61.922	259	125.82.900	215	126.37.985	170
110.34.666	48	113.97.046	54	116.61.923	259	125.86.101	237	126.37.986	170
110.34.671	47	113.97.071	54	116.61.924	215	125.86.102	237	126.37.990	170
110.34.674	47	113.97.210	55	116.61.925	215	125.86.303	237	126.37.996	170
110.34.686	68	113.97.224	55	116.71.100	127	125.86.304	237	126.37.997	170
110.34.687	68	113.97.227	55	117.14.620	134	125.86.901	238	126.37.998	170
110.35.271	6	113.97.246	54	117.25.401	131	125.86.902	238	126.38.925	172
110.35.371	6	113.97.272	54	117.26.400	131	125.87.101	237	126.40.900	172
110.35.390	4	113.97.410	55	117.28.331	132	125.87.102	237	126.45.046	29
110.35.391	5	113.97.424	55	117.31.936	135	125.87.131	237	126.45.049	29
110.35.392	4	113.97.427	55	117.44.200	68	125.87.132	237	126.45.965	29
110.35.393	5	115.39.050	189	117.50.610	114	125.87.152	237	126.45.969	29
110.46.084	29	115.39.051	189	117.67.955	126	125.87.305	238	126.53.003	166
110.46.087	29	115.39.052	189	117.95.330	114	125.87.306	238	126.53.303	166
110.52.435	185	115.39.053	189	117.95.630	114	125.87.307	257	126.53.702	166
110.52.440	137	115.39.054	190	117.97.351	118	125.87.333	238	126.53.902	166
110.52.441	137	115.39.055	190	117.97.352	118	125.87.334	237	126.63.000	164
110.52.442	137	115.39.058	190	117.97.357	118	125.87.354	237	126.63.001	163
110.52.450	137	116.05.922	132	117.97.358	118	125.87.901	238	126.63.002	164
110.52.451	137	116.05.931	132	117.97.359	118	125.87.902	238	126.63.003	163
110.52.452	137	116.05.959	132	118.30.103	241	125.87.903	257	126.63.004	164
110.52.460	137	116.07.017	136	118.68.104	4	125.87.931	238	126.63.005	163

Index

Item No.	Page	Item No.	Page	Item No.	Page	Item No.	Page	Item No.	Page
126.63.006	164	133.50.118	77	133.50.203	81	133.50.287	244	133.50.379	209
126.63.007	163	133.50.119	77	133.50.204	81	133.50.288	244	133.50.380	210
126.63.008	164	133.50.120	78	133.50.205	108	133.50.289	244	133.50.381	209
126.63.009	163	133.50.121	78	133.50.206	247	133.50.290	244	133.50.382	97
126.63.010	164	133.50.122	78	133.50.207	108	133.50.291	244	133.50.383	97
126.63.011	163	133.50.123	78	133.50.208	108	133.50.292	244	133.50.384	97
126.63.012	164	133.50.124	78	133.50.209	247	133.50.293	224	133.50.385	98
126.63.013	163	133.50.125	78	133.50.210	247	133.50.294	225	133.50.386	98
126.63.014	164	133.50.127	86	133.50.211	108	133.50.295	224	133.50.387	98
126.63.015	163	133.50.129	86	133.50.212	108	133.50.296	225	133.50.388	98
126.63.016	165	133.50.130	86	133.50.213	247	133.50.297	224	133.50.389	98
126.63.017	165	133.50.131	86	133.50.214	229	133.50.298	225	133.50.390	98
126.63.018	165	133.50.132	86	133.50.215	108	133.50.299	224	133.50.391	97
126.63.019	165	133.50.133	86	133.50.216	247	133.50.300	224	133.50.392	97
126.63.020	165	133.50.134	204	133.50.217	108	133.50.301	225	133.50.393	97
126.63.021	165	133.50.135	203	133.50.218	108	133.50.302	225	133.50.394	234
126.63.022	165	133.50.136	203	133.50.219	247	133.50.303	79	133.50.395	234
126.63.023	165	133.50.137	203	133.50.220	229	133.50.305	80	133.50.396	234
126.63.024	165	133.50.138	203	133.50.221	217	133.50.307	80	133.50.398	233
126.63.025	165	133.50.139	203	133.50.222	217	133.50.309	95	133.50.399	233
126.63.026	165	133.50.140	223	133.50.223	222	133.50.310	95	133.50.601	233
126.63.027	165	133.50.141	223	133.50.224	222	133.50.311	96	133.50.602	233
126.63.028	165	133.50.142	62	133.50.225	221	133.50.312	96	133.50.603	234
126.63.029	165	133.50.143	209	133.50.226	221	133.50.313	96	133.50.604	234
126.63.030	165	133.50.144	209	133.50.227	221	133.50.314	96	133.50.605	234
126.63.031	165	133.50.145	209	133.50.228	221	133.50.315	224	133.50.606	99
126.63.032	165	133.50.146	204	133.50.229	221	133.50.316	225	133.50.607	99
126.63.033	165	133.50.147	204	133.50.230	221	133.50.317	224	133.50.608	99
126.63.034	165	133.50.149	204	133.50.231	221	133.50.319	224	133.50.609	223
126.63.035	165	133.50.150	204	133.50.232	221	133.50.320	225	133.50.610	223
126.63.036	165	133.50.151	204	133.50.233	246	133.50.321	224	133.50.611	83
126.63.037	165	133.50.152	204	133.50.234	246	133.50.322	224	133.50.612	83
126.63.038	165	133.50.153	203	133.50.235	245	133.50.323	85	133.50.613	84
126.63.039	165	133.50.154	247	133.50.236	245	133.50.324	85	133.50.614	84
126.63.040	165	133.50.155	229	133.50.237	91	133.50.325	85	133.50.615	226
126.63.041	165	133.50.156	247	133.50.238	91	133.50.326	85	133.50.616	226
126.63.042	165	133.50.157	108	133.50.239	91	133.50.327	85	133.50.617	226
126.63.043	165	133.50.158	229	133.50.240	91	133.50.328	85	133.50.618	39
126.63.044	165	133.50.159	108	133.50.241	93	133.50.329	85	133.50.619	39
126.63.045	165	133.50.160	247	133.50.242	93	133.50.330	85	133.50.620	39
126.63.046	165	133.50.161	219	133.50.243	93	133.50.331	264	133.50.621	39
126.63.047	165	133.50.162	219	133.50.244	93	133.50.340	223	133.50.622	39
126.63.048	165	133.50.163	217	133.50.250	81	133.50.341	223	133.50.623	39
126.63.049	165	133.50.164	217	133.50.251	225	133.50.342	223	133.50.624	39
126.63.050	165	133.50.165	218	133.50.252	225	133.50.343	223	133.50.625	39
126.63.051	165	133.50.166	218	133.50.253	79	133.50.344	223	133.50.626	231
126.63.052	165	133.50.167	218	133.50.254	79	133.50.345	223	133.50.627	231
126.63.053	165	133.50.168	218	133.50.255	79	133.50.346	83	133.50.628	230
126.63.054	165	133.50.169	218	133.50.256	79	133.50.347	83	133.50.629	230
126.63.055	165	133.50.170	218	133.50.257	79	133.50.348	83	133.50.630	231
126.63.056	165	133.50.171	218	133.50.258	79	133.50.349	83	133.50.631	231
126.63.057	165	133.50.172	218	133.50.259	80	133.50.350	83	133.50.632	62
126.63.058	165	133.50.173	246	133.50.260	80	133.50.351	83	133.50.633	210
129.57.603	185	133.50.174	246	133.50.261	80	133.50.352	83	133.50.634	210
129.57.701	185	133.50.175	246	133.50.262	38	133.50.353	83	133.50.635	210
131.14.271	207	133.50.176	246	133.50.263	38	133.50.354	226	133.50.636	210
132.15.230	53	133.50.177	245	133.50.264	38	133.50.355	226	133.50.637	210
132.15.630	53	133.50.178	246	133.50.265	38	133.50.356	226	133.50.638	210
132.19.210	53	133.50.179	246	133.50.266	95	133.50.357	230	133.50.639	97
132.19.211	53	133.50.180	245	133.50.267	95	133.50.358	230	133.50.640	98
132.19.710	71	133.50.181	245	133.50.268	95	133.50.359	230	133.50.641	98
133.50.100	40	133.50.182	245	133.50.269	95	133.50.360	230	133.50.642	97
133.50.101	40	133.50.183	92	133.50.270	95	133.50.361	231	133.50.643	234
133.50.102	40	133.50.184	91	133.50.271	95	133.50.362	231	133.50.645	233
133.50.103	40	133.50.185	92	133.50.272	96	133.50.363	231	133.50.647	233
133.50.104	40	133.50.186	91	133.50.273	96	133.50.364	231	133.50.649	234
133.50.105	40	133.50.187	91	133.50.274	96	133.50.365	230	133.50.651	99
133.50.106	40	133.50.188	91	133.50.275	36	133.50.366	230	133.50.652	222
133.50.107	40	133.50.189	91	133.50.276	36	133.50.368	230	133.50.653	221
133.50.108	78	133.50.190	91	133.50.277	107	133.50.369	230	133.50.654	221
133.50.109	78	133.50.191	92	133.50.278	107	133.50.370	62	133.50.655	269
133.50.110	78	133.50.192	92	133.50.279	107	133.50.371	62	133.50.656	269
133.50.111	77	133.50.193	92	133.50.280	107	133.50.372	62	133.50.657	140
133.50.112	77	133.50.194	92	133.50.281	107	133.50.373	209	133.50.658	140
133.50.113	77	133.50.195	92	133.50.282	107	133.50.374	210	133.50.659	139
133.50.114	77	133.50.196	93	133.50.283	244	133.50.375	209	133.50.660	140
133.50.115	77	133.50.197	92	133.50.284	244	133.50.376	209	133.50.661	139
133.50.116	77	133.50.198	92	133.50.285	244	133.50.377	210	133.50.662	139
133.50.117	77	133.50.201	81	133.50.286	244	133.50.378	209	133.50.663	139

Index

Item No.	Page	Item No.	Page	Item No.	Page	Item No.	Page	Item No.	Page
133.50.664	142	133.53.068	217	133.53.148	201	133.53.228	267	133.53.376	151
133.50.665	141	133.53.069	220	133.53.149	201	133.53.251	265	133.53.377	149
133.50.666	142	133.53.070	217	133.53.150	268	133.53.297	103	133.53.378	150
133.50.667	141	133.53.071	219	133.53.151	200	133.53.298	103	133.53.379	150
133.50.668	142	133.53.072	219	133.53.152	200	133.53.299	248	133.53.380	150
133.50.669	142	133.53.073	220	133.53.153	200	133.53.300	249	133.53.381	150
133.50.670	141	133.53.074	220	133.53.154	200	133.53.301	249	133.53.382	149
133.50.671	141	133.53.075	219	133.53.155	200	133.53.302	249	133.53.383	145
133.50.672	142	133.53.076	264	133.53.156	200	133.53.303	249	133.53.384	147
133.50.673	141	133.53.078	93	133.53.157	200	133.53.304	252	133.53.385	147
133.50.674	142	133.53.079	93	133.53.158	268	133.53.305	252	133.53.386	147
133.50.675	141	133.53.080	93	133.53.159	202	133.53.306	252	133.53.387	147
133.50.676	142	133.53.081	94	133.53.160	202	133.53.307	252	133.53.388	145
133.50.677	141	133.53.082	94	133.53.161	200	133.53.308	155	133.53.389	101
133.50.678	140	133.53.083	266	133.53.162	200	133.53.309	155	133.53.390	102
133.50.679	141	133.53.084	94	133.53.163	202	133.53.310	155	133.53.391	102
133.50.680	142	133.53.085	94	133.53.165	202	133.53.311	155	133.53.392	102
133.50.681	36	133.53.086	94	133.53.166	268	133.53.312	151	133.53.393	101
133.50.682	59	133.53.087	94	133.53.167	202	133.53.313	151	133.53.394	104
133.50.683	59	133.53.088	94	133.53.168	202	133.53.314	151	133.53.395	104
133.50.684	59	133.53.089	94	133.53.169	202	133.53.315	151	133.53.396	104
133.50.685	59	133.53.090	266	133.53.170	202	133.53.316	151	133.53.397	103
133.50.686	59	133.53.091	94	133.53.171	202	133.53.317	149	133.53.398	105
133.50.687	60	133.53.092	266	133.53.172	202	133.53.318	148	133.53.399	105
133.50.688	60	133.53.093	266	133.53.173	202	133.53.319	148	133.53.400	105
133.50.689	60	133.53.094	73	133.53.174	268	133.53.320	148	133.53.401	105
133.50.690	60	133.53.095	73	133.53.175	84	133.53.321	148	133.53.402	144
133.50.691	60	133.53.096	73	133.53.176	84	133.53.322	149	133.53.403	144
133.50.692	61	133.53.097	73	133.53.177	84	133.53.323	145	133.53.404	158
133.50.693	61	133.53.098	74	133.53.178	84	133.53.324	146	133.53.405	158
133.50.694	60	133.53.099	74	133.53.179	84	133.53.325	146	133.53.406	158
133.50.695	59	133.53.100	74	133.53.180	265	133.53.326	146	133.53.407	158
133.50.696	59	133.53.101	74	133.53.181	84	133.53.327	146	133.53.408	158
133.50.697	61	133.53.102	74	133.53.182	82	133.53.328	145	133.53.409	153
133.50.698	61	133.53.103	73	133.53.183	82	133.53.329	101	133.53.410	154
133.50.700	61	133.53.104	73	133.53.184	82	133.53.330	102	133.53.411	248
133.50.701	61	133.53.105	74	133.53.185	82	133.53.331	102	133.53.412	249
133.50.702	61	133.53.106	73	133.53.186	82	133.53.332	102	133.53.413	249
133.50.705	62	133.53.107	74	133.53.187	265	133.53.333	101	133.53.414	249
133.50.707	59	133.53.108	37	133.53.188	82	133.53.334	104	133.53.415	249
133.50.708	60	133.53.109	37	133.53.189	82	133.53.335	104	133.53.416	248
133.50.709	60	133.53.110	37	133.53.190	82	133.53.336	104	133.53.417	250
133.50.710	61	133.53.111	262	133.53.191	82	133.53.337	103	133.53.418	250
133.50.711	143	133.53.112	37	133.53.192	82	133.53.338	105	133.53.419	250
133.53.003	264	133.53.113	38	133.53.193	82	133.53.339	105	133.53.420	250
133.53.019	143	133.53.114	38	133.53.194	265	133.53.340	105	133.53.421	252
133.53.020	143	133.53.115	38	133.53.195	82	133.53.341	105	133.53.422	252
133.53.021	143	133.53.116	262	133.53.196	265	133.53.342	157	133.53.423	252
133.53.022	200	133.53.117	38	133.53.197	232	133.53.343	157	133.53.424	252
133.53.033	73	133.53.118	37	133.53.198	232	133.53.344	157	133.53.425	156
133.53.034	74	133.53.119	37	133.53.199	232	133.53.345	157	133.53.426	156
133.53.035	73	133.53.120	37	133.53.200	232	133.53.346	157	133.53.427	156
133.53.036	73	133.53.121	262	133.53.201	232	133.53.347	154	133.53.428	156
133.53.037	74	133.53.122	37	133.53.202	232	133.53.348	154	133.53.429	152
133.53.038	74	133.53.123	262	133.53.203	263	133.53.349	154	133.53.430	152
133.53.039	75	133.53.124	78	133.53.204	263	133.53.350	154	133.53.431	152
133.53.040	75	133.53.125	78	133.53.205	232	133.53.351	153	133.53.432	152
133.53.046	139	133.53.126	78	133.53.206	232	133.53.352	154	133.53.433	152
133.53.047	139	133.53.127	75	133.53.207	232	133.53.353	154	133.53.434	149
133.53.048	140	133.53.128	75	133.53.208	232	133.53.354	154	133.53.435	150
133.53.049	140	133.53.129	75	133.53.209	232	133.53.355	103	133.53.436	150
133.53.050	139	133.53.130	75	133.53.210	232	133.53.356	103	133.53.437	150
133.53.051	140	133.53.131	75	133.53.211	263	133.53.359	248	133.53.438	150
133.53.052	139	133.53.132	75	133.53.212	263	133.53.360	250	133.53.439	149
133.53.053	140	133.53.133	75	133.53.213	99	133.53.361	250	133.53.440	145
133.53.054	269	133.53.134	76	133.53.214	99	133.53.362	250	133.53.441	146
133.53.055	269	133.53.135	76	133.53.215	99	133.53.363	250	133.53.442	146
133.53.056	264	133.53.136	76	133.53.216	99	133.53.364	251	133.53.443	146
133.53.057	220	133.53.137	76	133.53.217	267	133.53.365	251	133.53.444	146
133.53.058	217	133.53.138	76	133.53.218	100	133.53.366	251	133.53.445	145
133.53.059	220	133.53.139	76	133.53.219	100	133.53.367	251	133.53.446	101
133.53.060	217	133.53.140	76	133.53.220	100	133.53.368	156	133.53.447	102
133.53.061	222	133.53.141	76	133.53.221	100	133.53.369	156	133.53.448	102
133.53.062	222	133.53.142	76	133.53.222	267	133.53.370	156	133.53.449	102
133.53.063	220	133.53.143	201	133.53.223	100	133.53.371	156	133.53.450	101
133.53.064	222	133.53.144	201	133.53.224	100	133.53.372	151	133.53.451	106
133.53.065	222	133.53.145	201	133.53.225	100	133.53.373	151	133.53.452	106
133.53.066	264	133.53.146	201	133.53.226	100	133.53.374	151	133.53.453	106
133.53.067	220	133.53.147	201	133.53.227	267	133.53.375	151	133.53.454	106

Index

Item No.	Page	Item No.	Page	Item No.	Page	Item No.	Page	Item No.	Page
133.53.455	144	134.43.401	134	155.00.810	121	155.01.851	26	155.02.153	193
133.53.456	144	134.43.404	134	155.00.811	121	155.01.852	25	155.02.160	194
133.53.457	157	134.43.601	134	155.00.813	121	155.01.853	26	155.02.162	194
133.53.458	157	134.43.801	135	155.00.816	121	155.01.854	25	155.02.163	193
133.53.459	157	134.45.110	122	155.00.820	119	155.01.855	26	155.02.190	193
133.53.460	157	134.45.308	135	155.00.821	119	155.01.860	27	155.02.200	199
133.53.461	157	134.45.602	243	155.00.822	119	155.01.861	26	155.02.210	199
133.53.462	153	134.46.609	134	155.00.823	119	155.01.862	27	155.02.220	199
133.53.463	153	134.81.617	120	155.00.833	116	155.01.863	27	155.02.240	28
133.53.464	153	134.81.626	120	155.00.835	116	155.01.864	27	155.02.241	28
133.53.465	153	134.82.605	11	155.00.840	124	155.01.865	27	155.02.242	28
133.53.466	153	134.83.602	11	155.00.841	124	155.01.870	25	155.02.243	28
133.53.467	103	135.08.900	56	155.00.842	124	155.01.871	27	155.02.252	193
133.53.468	103	135.73.400	72	155.00.843	124	155.01.880	54	155.02.260	194
133.53.470	248	135.73.410	72	155.00.845	124	155.01.881	54	155.02.320	21
133.53.471	248	136.06.212	11	155.00.846	124	155.01.890	54	155.02.321	21
133.53.472	248	136.06.614	11	155.00.870	119	155.01.891	54	155.02.322	22
133.53.473	248	136.75.300	128	155.00.871	119	155.01.902	51	155.02.330	21
133.53.474	248	136.76.205	11	155.00.883	116	155.01.903	52	155.02.331	21
133.53.475	251	136.76.610	8	155.00.885	116	155.01.904	51	155.02.332	22
133.53.476	251	136.81.210	208	155.00.891	128	155.01.905	52	155.02.340	21
133.53.477	251	136.81.610	208	155.00.901	127	155.01.912	51	155.02.341	21
133.53.478	251	136.87.619	188	155.00.911	127	155.01.913	52	155.02.342	22
133.53.479	155	137.21.500	11	155.00.921	127	155.01.914	51	155.02.350	21
133.53.480	155	137.42.606	240	155.00.931	122	155.01.915	52	155.02.351	21
133.53.481	155	137.45.002	243	155.00.932	122	155.01.922	51	155.02.352	22
133.53.482	155	137.45.331	243	155.00.951	119	155.01.923	52	155.02.360	29
133.53.483	152	138.69.353	126	155.00.952	119	155.01.924	51	155.02.361	29
133.53.484	152	138.72.800	72	155.00.953	122	155.01.925	52	158.23.300	185
133.53.485	152	139.60.422	72	155.00.954	122	155.01.930	161	161.16.600	8
133.53.486	152	151.04.319	49	155.00.956	122	155.01.931	161	192.29.300	185
133.53.487	152	151.09.610	187	155.00.971	30	155.01.932	161	192.48.456	185
133.53.488	149	151.11.671	188	155.00.984	115	155.01.940	161	196.74.107	195
133.53.489	148	151.12.606	187	155.00.985	115	155.01.941	161	842.01.909	275
133.53.490	148	151.36.222	187	155.00.986	115	155.01.942	161	842.02.906	275
133.53.491	148	151.40.203	193	155.00.988	115	155.01.950	184	842.34.000*	275
133.53.492	148	151.40.204	193	155.00.989	116	155.01.951	184	842.34.010*	275
133.53.493	149	151.40.207	193	155.00.990	116	155.01.960	184	842.34.050*	275
133.53.494	145	151.40.603	194	155.00.991	115	155.01.961	184	843.63.050	272
133.53.495	147	151.40.604	194	155.00.992	116	155.01.971	197	843.65.600	272
133.53.496	147	151.40.607	194	155.00.993	115	155.01.973	197	843.65.900	272
133.53.497	147	151.40.633	193	155.00.994	115	155.01.974	197	843.77.000	272
133.53.498	147	151.40.634	193	155.00.995	115	155.01.982	197	843.77.200	272
133.53.499	145	151.54.400	48	155.01.450	120	155.01.983	197	843.77.900	272
133.53.500	101	151.54.600	48	155.01.451	120	155.01.984	197	843.81.200	271
133.53.501	102	151.67.001	187	155.01.452	120	155.01.991	20	843.81.600	271
133.53.502	102	151.67.602	188	155.01.453	120	155.01.992	20	844.69.220	271
133.53.503	102	151.85.030	162	155.01.460	117	155.01.993	20	844.69.230	271
133.53.504	101	151.85.089	162	155.01.461	117	155.02.001	20	844.69.240	271
133.53.505	104	151.85.930	162	155.01.462	117	155.02.002	20	844.69.630	271
133.53.506	104	151.85.989	162	155.01.463	117	155.02.003	20	844.69.640	271
133.53.507	104	151.86.030	162	155.01.465	117	155.02.011	20	845.00.809	274
133.53.508	103	151.86.089	162	155.01.510	10	155.02.012	20	845.01.300	274
133.53.509	106	151.86.930	162	155.01.511	10	155.02.013	20	845.01.340	275
133.53.510	106	151.86.989	162	155.01.512	10	155.02.025	123	845.01.540	275
133.53.511	106	151.90.351	195	155.01.517	117	155.02.027	123	845.01.600	274
133.53.512	106	151.90.951	195	155.01.540	241	155.02.030	123	845.01.620*	274
133.53.513	144	151.92.100	215	155.01.543	241	155.02.032	123	845.01.806	274
133.53.514	144	151.92.880	215	155.01.571	10	155.02.040	70	845.02.803	274
133.53.515	158	152.00.727	185	155.01.572	10	155.02.041	69	845.05.200	273
133.53.516	158	152.16.001	47	155.01.632	171	155.02.042	69	845.05.300	273
133.53.517	158	153.20.715	183	155.01.782	51	155.02.043	70	845.05.430	275
133.53.518	158	155.00.010	183	155.01.783	52	155.02.050	70	845.05.600	273
133.53.519	158	155.00.011	183	155.01.784	51	155.02.051	69	845.05.730	275
133.57.610	16	155.00.230	183	155.01.785	52	155.02.052	69	845.08.120	273
133.57.611	16	155.00.240	183	155.01.794	184	155.02.053	70	845.08.220	273
133.57.612	16	155.00.270	185	155.01.830	26	155.02.060	70	845.08.620	273
133.57.613	16	155.00.275	185	155.01.831	25	155.02.061	69	845.10.805	274
134.09.001	196	155.00.350	28	155.01.832	26	155.02.062	69	845.11.802	274
134.09.330	196	155.00.360	121	155.01.833	25	155.02.063	70	845.12.809	274
134.09.633	196	155.00.361	121	155.01.834	26	155.02.070	70	885.06.209	274
134.09.730	196	155.00.490	125	155.01.835	25	155.02.071	69	901.00.581	261
134.33.320	242	155.00.491	125	155.01.840	26	155.02.072	69	901.00.583	261
134.33.321	242	155.00.492	125	155.01.841	27	155.02.073	70	901.00.586	261
134.33.940	242	155.00.493	125	155.01.842	27	155.02.080	69		
134.35.320	122	155.00.494	125	155.01.843	26	155.02.081	70		
134.41.001	128	155.00.570	11	155.01.844	27	155.02.083	70		
134.43.201	136	155.00.591	131	155.01.845	26	155.02.084	69		
134.43.331	136	155.00.660	208	155.01.850	25	155.02.150	194		

Decorative Hardware Finish Codes

In an effort to ensure customers order and receive the products which best fit their design vision, we have devised a system which seeks to add peace of mind regarding the consistency of fit and finish across our suppliers.

The first three digits of the code denote the finish, the following two letters specify the base material that the item is made from and the final two digits account for the manufacturing facility.

Example: 104ZN26
104 = Pewter
ZN = Zinc
26 = Factory Designation

Index by Finish

Finish Description	Code	Item No.	Page	Finish Description	Code	Item No.	Page
ALUMINUM, MATT							
	106AL03	126.19.900	171		106AL69	103.89.903	56
	106AL15	112.82.903	31		106AL69	103.89.904	56
	106AL15	112.82.904	31		106AL69	103.89.905	56
	106AL15	112.82.907	31		106AL69	103.89.913	56
	106AL15	112.82.910	31		106AL69	117.67.955	126
	106AL15	112.83.900	130		106AL69	135.08.900	56
	106AL15	112.83.902	129		106AL70	842.01.909	275
	106AL15	112.83.903	130		106AL70	842.02.906	275
	106AL15	112.83.904	129		106PL37	126.37.980	170
	106AL15	112.83.906	130		106PL37	126.37.981	170
	106AL15	112.83.909	129		106PL37	126.37.985	170
	106AL15	112.83.910	130		106PL37	126.37.986	170
	106AL15	112.83.911	129		106PL37	126.37.996	170
	106AL15	151.85.930	162		106PL37	126.37.997	170
	106AL15	151.86.930	162		106PL37	126.37.998	170
	106AL23	155.00.984	115		106PL38	126.63.016	165
	106AL23	155.00.985	115		106PL38	126.63.020	165
	106AL23	155.00.986	115		106PL38	126.63.024	165
	106AL23	155.00.988	115		106PL38	126.63.028	165
	106AL23	155.00.989	116		106PL38	126.63.032	165
	106AL23	155.00.990	116		106PL38	126.63.036	165
	106AL23	155.00.991	116		106PL38	126.63.040	165
	106AL23	155.00.992	116		106PL38	126.63.044	165
	106AL23	155.00.993	115		106PL38	126.63.048	165
	106AL23	155.00.994	115		106PL38	126.63.052	165
	106AL23	155.00.995	115		106ZN08	106.11.904	171
	106AL37	108.94.923	32		106ZN15	151.85.989	162
	106AL37	126.35.925	172		106ZN15	151.86.989	162
	106AL37	126.36.900	167		106ZN26	107.40.902	8
	106AL37	126.37.900	167		106ZN27	155.00.230	183
	106AL37	126.37.912	169		106ZN49	155.01.931	161
	106AL37	126.37.922	169	ALUMINUM, SATIN			
	106AL37	126.38.925	172		116AL93	126.40.900	172
	106AL37	126.53.902	166	ALUMINUM, POLISHED			
	106AL38	106.04.000	180		132AL70	845.00.809	274
	106AL38	106.04.010	180		132AL70	845.10.805	274
	106AL38	106.04.060	179		132AL70	845.11.802	274
	106AL38	106.04.070	179		132AL70	845.12.809	274
	106AL38	106.04.080	178	ANTIQUE ENGLISH			
	106AL38	106.04.090	177		128ZN49	118.30.103	241
	106AL38	106.04.100	176		128ZN57	107.13.112	241
	106AL38	106.04.110	175		128ZN60	120.62.110	241
	106AL38	106.04.120	174	BLACK			
	106AL38	106.04.130	173		110PL04	129.57.603	185
	106AL38	126.63.000	164		110PL44	138.69.353	126
	106AL38	126.63.004	164		110PL67	158.23.300	185
	106AL38	126.63.008	164	BLACK OXIDE			
	106AL38	126.63.012	164		154ZN41	118.94.310	213
	106AL40	126.45.965	29		154ZN41	118.95.310	213
	106AL40	126.45.969	29	BLACK, ANTIQUE			
	106AL40	155.02.330	21		118ZN08	121.90.302	242
	106AL40	155.02.331	21		118ZN08	134.33.320	242
	106AL40	155.02.332	22		118ZN72	110.93.361	214
	106AL53	116.05.922	132		118ZN72	110.93.362	214
	106AL53	116.05.931	132		118ZN73	133.50.293	224
	106AL53	116.05.959	132		118ZN73	133.50.315	224
	106AL69	103.89.901	56				
	106AL69	103.89.902	56				

Index by Finish

Finish Description	Code	Item No.	Page	Finish Description	Code	Item No.	Page
BLACK, MATT							
	109AL12	155.02.027	123		109ZN22	108.76.250	13
	109AL12	155.02.032	123		109ZN23	103.30.805	5
	109AL38	106.04.003	180		109ZN23	103.30.806	5
	109AL38	106.04.013	180		109ZN23	110.34.306	24
	109AL38	106.04.021	57		109ZN23	110.34.307	24
	109AL38	106.04.031	58		109ZN23	110.34.327	6
	109AL38	106.04.031	58		109ZN23	110.34.355	6
	109AL38	106.04.041	58		109ZN23	110.35.371	6
	109AL38	106.04.051	57		109ZN23	110.35.393	5
	109AL38	106.04.063	179		109ZN23	118.68.804	5
	109AL38	106.04.073	179		109ZN34	106.65.346	50
	109AL38	106.04.083	178		109ZN34	106.65.350	50
	109AL38	106.04.093	177		109ZN37	102.81.320	15
	109AL38	106.04.103	176		109ZN38	102.47.303	16
	109AL38	106.04.113	175		109ZN38	102.47.319	114
	109AL38	106.04.123	174		109ZN38	102.47.323	34
	109AL38	106.04.133	173		109ZN38	102.47.333	34
	109AL38	110.52.441	137		109ZN38	102.47.343	34
	109AL38	110.52.451	137		109ZN38	102.47.353	33
	109AL38	110.52.461	137		109ZN38	102.47.363	33
	109AL38	110.52.471	138		109ZN38	102.47.373	260
	109AL38	110.52.481	138		109ZN38	102.47.383	260
	109AL38	126.63.003	163		109ZN38	102.47.393	35
	109AL38	126.63.007	163		109ZN38	133.57.613	16
	109AL38	126.63.011	163		109ZN41	155.01.974	197
	109AL38	126.63.015	163		109ZN41	155.01.984	197
	109AL40	132.19.211	53		109ZN43	106.70.003	46
	109AL40	155.02.320	21		109ZN43	106.70.011	46
	109AL40	155.02.321	21		109ZN49	117.95.330	114
	109AL40	155.02.322	22		109ZN49	155.01.932	161
	109AL40	155.02.360	29		109ZN49	155.01.942	161
	109AL40	155.02.361	29		109ZN49	845.01.340	275
	109AL43	106.70.040	23		109ZN49	845.05.430	275
	109AL43	106.70.041	23		109ZN49	901.00.583	261
	109AL43	106.70.042	23		109ZN59	107.20.303	134
	109AL43	106.70.072	23		109ZN73	133.50.149	247
	109AL43	106.70.082	23		109ZN73	133.50.154	247
	109BR28	151.04.319	49		109ZN73	133.50.206	247
	109PL02	136.75.300	128		109ZN73	133.50.207	108
	109PL38	126.63.019	165		109ZN73	133.50.208	108
	109PL38	126.63.023	165		109ZN73	133.50.209	247
	109PL38	126.63.027	165		109ZN73	133.50.294	225
	109PL38	126.63.031	165		109ZN73	133.50.295	224
	109PL38	126.63.035	165		109ZN73	133.50.316	225
	109PL38	126.63.039	165		109ZN73	133.50.317	224
	109PL38	126.63.043	165		109ZN73	133.53.355	103
	109PL38	126.63.047	165		109ZN73	133.53.356	103
	109PL38	126.63.051	165		109ZN73	133.53.359	248
	109PL38	126.63.055	165		109ZN73	133.53.360	250
	109SS73	133.53.377	149		109ZN73	133.53.361	250
	109SS73	133.53.378	150		109ZN73	133.53.362	250
	109SS73	133.53.379	150		109ZN73	133.53.363	250
	109SS73	133.53.380	150		109ZN73	133.53.364	251
	109SS73	133.53.381	150		109ZN73	133.53.365	251
	109SS73	133.53.382	149		109ZN73	133.53.366	251
	109ST23	155.00.883	116		109ZN73	133.53.367	251
	109ST23	155.00.885	116		109ZN73	133.53.368	156
	109ST38	116.09.340	132		109ZN73	133.53.369	156
	109ZN08	104.66.300	10		109ZN73	133.53.370	156
	109ZN08	110.29.356	112		109ZN73	133.53.371	156
	109ZN08	110.29.358	112		109ZN73	133.53.372	151
	109ZN08	116.22.316	49		109ZN73	133.53.373	151
	109ZN08	116.22.334	123		109ZN73	133.53.374	151
	109ZN08	116.22.343	123		109ZN73	133.53.375	151
	109ZN12	106.70.100	89		109ZN73	133.53.376	151
	109ZN12	106.70.101	89		109ZN73	133.53.383	145
	109ZN12	106.70.102	89		109ZN73	133.53.384	147
	109ZN12	106.70.120	89		109ZN73	133.53.385	147
	109ZN12	155.02.243	28		109ZN73	133.53.386	147
	109ZN13	105.63.300	15		109ZN73	133.53.387	147
	109ZN22	108.76.240	13		109ZN73	133.53.388	145
	109ZN22	108.76.245	13		109ZN73	133.53.389	101

Index by Finish

Finish Description	Code	Item No.	Page	Finish Description	Code	Item No.	Page
BLACK, MATT	109ZN73	133.53.390	102	BLACK, TEXTURED	RAL9017	155.01.870	25
	109ZN73	133.53.391	102		113ZN08	117.28.331	132
	109ZN73	133.53.392	102	BRASS, ANTIQUE			
	109ZN73	133.53.393	101		111BR35	125.16.101	240
	109ZN73	133.53.394	104		111ZN14	125.86.101	237
	109ZN73	133.53.395	104		111ZN14	125.86.102	237
	109ZN73	133.53.396	104		111ZN14	125.87.101	237
	109ZN73	133.53.397	103		111ZN14	125.87.102	237
	109ZN73	133.53.398	105		111ZN14	125.87.131	237
	109ZN73	133.53.399	105		111ZN14	125.87.132	237
	109ZN73	133.53.400	105		111ZN14	125.87.152	237
	109ZN73	133.53.401	105		111ZN26	125.61.100	213
	109ZN73	133.53.402	144		111ZN49	125.28.100	241
	109ZN73	133.53.403	144	BRASS, ANTIQUE SATIN			
	109ZN73	133.53.404	158		133ZN12	106.70.131	3
	109ZN73	133.53.405	158		133ZN72	110.93.461	214
	109ZN73	133.53.406	158		133ZN72	110.93.462	214
	109ZN73	133.53.407	158	BRASS, BRUSHED/SATIN			
	109ZN73	133.53.408	158		119AL40	132.19.210	53
	109ZN96	101.69.510	19		119AL40	155.02.351	21
	109ZN96	101.69.511	19		119AL40	155.02.350	21
BLACK, MATT/BRONZE, CHAMPAGNE					119AL40	155.02.352	22
	221ZN73	133.53.347	154		119BR01	100.61.676	258
	221ZN73	133.53.348	154		119BR01	116.35.665	194
	221ZN73	133.53.349	154		119BR01	116.36.616	258
	221ZN73	133.53.350	154		119BR01	123.02.651	199
	221ZN73	133.53.351	153		119BR01	123.02.653	199
BLACK, MATT/CHROME, POLISHED					119BR01	123.02.660	194
	222ZN73	133.53.462	153		119BR01	123.02.670	193
	222ZN73	133.53.463	153		119BR01	151.40.633	193
	222ZN73	133.53.464	153		119BR01	151.40.634	193
	222ZN73	133.53.465	153		119BR01	155.02.200	199
	222ZN73	133.53.466	153		119BR50	116.39.553	135
BLACK, MATT/MARBLE, WHITE					119BR69	137.21.500	11
	219ZN12	106.70.175	65		119BR75	155.01.572	10
	219ZN12	106.70.180	65		119BR75	155.02.162	194
BLACK, MATT/NICKEL, SATIN					119BR75	155.02.190	193
	136ZN73	133.53.352	154		119BR75	155.02.210	199
	136ZN73	133.53.353	154		119BR75	155.02.220	199
	136ZN73	133.53.354	154		119ZN12	155.02.043	70
	136ZN73	133.53.409	153		119ZN12	155.02.053	70
	136ZN73	133.53.410	154		119ZN12	155.02.063	70
BLACK, POLISHED					119ZN12	155.02.073	70
	135ZN22	105.43.300	50		119ZN12	155.02.081	70
BLACK, RAL9005					119ZN12	155.02.242	28
	RAL9005	126.36.300	167		119ZN23	155.01.993	20
	RAL9005	126.37.300	167		119ZN23	155.02.003	20
	RAL9005	126.37.312	169		119ZN23	155.02.013	20
	RAL9005	126.37.322	169		119ZN27	106.69.502	8
	RAL9005	126.37.370	170		119ZN27	155.01.785	52
	RAL9005	126.37.371	170		119ZN27	155.01.794	184
	RAL9005	126.37.374	170		119ZN27	155.01.905	52
	RAL9005	126.37.375	170		119ZN27	155.01.915	52
	RAL9005	126.37.936	170		119ZN27	155.01.925	52
	RAL9005	126.37.937	170		119ZN49	155.01.950	184
	RAL9005	126.37.938	170		119ZN49	155.01.960	184
	RAL9005	126.53.303	166	BRASS, POLISHED			
BLACK, RAL9017					114BR50	121.88.868	240
	RAL9017	106.69.501	8		114ME41	134.43.801	135
	RAL9017	155.01.830	26		114ZN43	106.70.005	46
	RAL9017	155.01.831	25	BRASS, RUSTIC			
	RAL9017	155.01.832	26		129BR35	125.72.102	241
	RAL9017	155.01.833	25		129BR35	125.73.113	241
	RAL9017	155.01.834	26	BRITANNIUM			
	RAL9017	155.01.835	25		125BT19	116.61.000	216
	RAL9017	155.01.850	25		125BT19	116.61.002	216
	RAL9017	155.01.851	26		125BT19	116.61.007	259
	RAL9017	155.01.852	25		125BT19	116.61.008	259
	RAL9017	155.01.853	26		125BT19	125.82.900	215
	RAL9017	155.01.854	25		125BT19	151.92.880	215
	RAL9017	155.01.855	26				

Index by Finish

Finish Description	Code	Item No.	Page	Finish Description	Code	Item No.	Page
BRONZE, ANTIQUE					185BZ19	116.61.923	259
	120ZN08	122.18.129	240		185BZ19	116.61.924	215
BRONZE, BLACK					185BZ19	116.61.925	215
	190ST73	133.53.046	139	BRONZE, CHAMPAGNE	220SS73	133.53.317	149
	190ST73	133.53.047	139		220SS73	133.53.318	148
	190ST73	133.53.048	140		220SS73	133.53.319	148
	190ST73	133.53.049	140		220SS73	133.53.320	148
	190ST73	133.53.050	139		220SS73	133.53.321	148
	190ST73	133.53.051	140		220SS73	133.53.322	149
	190ST73	133.53.052	139		220ZN73	133.53.297	103
	190ST73	133.53.053	140		220ZN73	133.53.298	103
	190ST73	133.53.054	269		220ZN73	133.53.299	248
	190ZN73	133.50.161	219		220ZN73	133.53.300	249
	190ZN73	133.50.162	219		220ZN73	133.53.301	249
	190ZN73	133.50.163	217		220ZN73	133.53.302	249
	190ZN73	133.50.164	217		220ZN73	133.53.303	249
	190ZN73	133.50.221	217		220ZN73	133.53.304	252
	190ZN73	133.50.222	217		220ZN73	133.53.305	252
	190ZN73	133.50.223	222		220ZN73	133.53.306	252
	190ZN73	133.50.224	222		220ZN73	133.53.307	252
	190ZN73	133.50.652	222		220ZN73	133.53.308	155
	190ZN73	133.53.056	264		220ZN73	133.53.309	155
	190ZN73	133.53.078	93		220ZN73	133.53.310	155
	190ZN73	133.53.079	93		220ZN73	133.53.311	155
	190ZN73	133.53.080	93		220ZN73	133.53.312	151
	190ZN73	133.53.081	94		220ZN73	133.53.313	151
	190ZN73	133.53.082	94		220ZN73	133.53.314	151
	190ZN73	133.53.083	266		220ZN73	133.53.315	151
	190ZN73	133.53.084	94		220ZN73	133.53.316	151
	190ZN73	133.53.108	37		220ZN73	133.53.323	145
	190ZN73	133.53.109	37		220ZN73	133.53.324	146
	190ZN73	133.53.110	37		220ZN73	133.53.325	146
	190ZN73	133.53.111	262		220ZN73	133.53.326	146
	190ZN73	133.53.112	37		220ZN73	133.53.327	146
	190ZN73	133.53.143	201		220ZN73	133.53.328	145
	190ZN73	133.53.144	201		220ZN73	133.53.329	101
	190ZN73	133.53.145	201		220ZN73	133.53.330	102
	190ZN73	133.53.146	201		220ZN73	133.53.331	102
	190ZN73	133.53.147	201		220ZN73	133.53.332	102
	190ZN73	133.53.148	201		220ZN73	133.53.333	101
	190ZN73	133.53.149	201		220ZN73	133.53.334	104
	190ZN73	133.53.150	268		220ZN73	133.53.335	104
	190ZN73	133.53.175	84		220ZN73	133.53.336	104
	190ZN73	133.53.176	84		220ZN73	133.53.337	103
	190ZN73	133.53.177	84		220ZN73	133.53.338	105
	190ZN73	133.53.178	84		220ZN73	133.53.339	105
	190ZN73	133.53.179	84		220ZN73	133.53.340	105
	190ZN73	133.53.180	265		220ZN73	133.53.341	105
	190ZN73	133.53.181	84		220ZN73	133.53.342	157
	190ZN73	133.53.197	232		220ZN73	133.53.343	157
	190ZN73	133.53.198	232		220ZN73	133.53.344	157
	190ZN73	133.53.199	232		220ZN73	133.53.345	157
	190ZN73	133.53.200	232		220ZN73	133.53.346	157
	190ZN73	133.53.201	232	BRONZE, DARK	108AL38	106.04.022	57
	190ZN73	133.53.202	232		108AL38	106.04.032	58
	190ZN73	133.53.203	263		108AL38	106.04.042	58
	190ZN73	133.53.213	99		108AL38	106.04.052	57
	190ZN73	133.53.214	99		108AL38	106.04.062	179
	190ZN73	133.53.215	99		108AL38	106.04.072	179
	190ZN73	133.53.216	99		108AL38	106.04.082	178
	190ZN73	133.53.217	267		108AL38	106.04.092	177
BRONZE, BLACK/NICKEL, POLISHED	202SS73	133.50.682	59		108AL38	106.04.102	176
	202SS73	133.50.683	59		108AL38	106.04.112	175
	202SS73	133.50.684	59		108AL38	106.04.122	174
	202SS73	133.50.685	59		108AL38	106.04.132	173
	202SS73	133.50.686	59		108AL38	110.52.442	137
	202SS73	133.50.707	59		108AL38	110.52.452	137
BRONZE, BRUSHED/SATIN					108AL38	110.52.462	137
	185BZ19	116.61.920	216		108AL38	110.52.472	138
	185BZ19	116.61.921	216		108AL38	110.52.482	138
	185BZ19	116.61.922	259				

Index by Finish

Finish Description	Code	Item No.	Page	Finish Description	Code	Item No.	Page
BRONZE, DARK OIL-RUBBED							
	108AL38	126.63.002	164		105ZN14	125.87.305	238
	108AL38	126.63.006	164		105ZN14	125.87.306	238
	108AL38	126.63.010	164		105ZN14	125.87.307	257
	108AL38	126.63.014	164		105ZN14	125.87.333	238
	108ME41	134.43.331	136		105ZN14	125.87.334	237
	108PL38	126.63.018	165		105ZN14	125.87.354	237
	108PL38	126.63.022	165		105ZN27	106.61.043	7
	108PL38	126.63.026	165		105ZN27	106.61.044	7
	108PL38	126.63.030	165		105ZN27	155.01.782	51
	108PL38	126.63.034	165		105ZN27	155.01.902	51
	108PL38	126.63.038	165		105ZN27	155.01.912	51
	108PL38	126.63.042	165		105ZN27	155.01.922	51
	108PL38	126.63.046	165		105ZN35	120.70.303	240
	108PL38	126.63.050	165		105ZN38	113.97.410	55
	108PL38	126.63.054	165		105ZN38	113.97.424	55
	108ST23	155.00.870	119		105ZN38	113.97.427	55
	108ST23	155.00.871	119		105ZN49	120.61.350	122
	108ST50	116.07.323	136		105ZN49	125.67.351	229
	108ST50	116.07.333	136		105ZN49	125.67.352	229
	108ZN08	103.06.300	196		105ZN49	134.45.110	122
	108ZN08	104.33.330	7		105ZN49	151.90.351	195
	108ZN08	105.61.300	196		105ZN49	901.00.581	261
	108ZN08	120.17.370	240		105ZN72	110.93.161	214
	108ZN08	121.90.301	242		105ZN72	110.93.162	214
	108ZN08	134.09.330	196		105ZN72	110.93.191	241
	108ZN08	134.33.321	242		105ZN72	110.93.192	241
	108ZN08	134.35.320	122		105ZN73	133.50.137	203
	108ZN41	845.08.120	273		105ZN73	133.50.140	223
	108ZN49	121.46.350	243		105ZN73	133.50.144	209
	108ZN49	125.61.351	243		105ZN73	133.50.150	204
	108ZN49	137.45.331	243		105ZN73	133.50.155	229
	108ZN49	845.01.300	274		105ZN73	133.50.156	247
	108ZN49	845.05.300	273		105ZN73	133.50.165	218
BRONZE, HIGHLIGHTED ANTIQUE					105ZN73	133.50.166	218
	138BR22	108.57.111	49		105ZN73	133.50.167	218
BRONZE, LIGHT					105ZN73	133.50.168	218
	216AL12	106.70.202	43		105ZN73	133.50.173	246
	216AL12	106.70.212	43		105ZN73	133.50.174	246
	216ZN12	106.70.186	43		105ZN73	133.50.175	246
BRONZE, OIL-RUBBED					105ZN73	133.50.187	91
	105AL40	126.45.046	29		105ZN73	133.50.188	91
	105AL40	126.45.049	29		105ZN73	133.50.189	91
	105IR14	125.88.311	239		105ZN73	133.50.190	91
	105IR14	125.88.312	239		105ZN73	133.50.190	91
	105IR14	125.88.314	239		105ZN73	133.50.210	247
	105IR14	125.88.315	257		105ZN73	133.50.211	108
	105IR14	125.88.343	239		105ZN73	133.50.212	108
	105IR14	125.88.355	239		105ZN73	133.50.213	247
	105ST43	117.97.351	118		105ZN73	133.50.214	229
	105ST43	117.97.352	118		105ZN73	133.50.225	221
	105ST43	117.97.357	118		105ZN73	133.50.226	221
	105ST43	117.97.358	118		105ZN73	133.50.227	221
	105ST43	117.97.359	118		105ZN73	133.50.228	221
	105ST50	116.09.324	136		105ZN73	133.50.233	246
	105ZN12	106.70.173	66		105ZN73	133.50.239	91
	105ZN12	106.70.220	66		105ZN73	133.50.240	91
	105ZN12	106.70.221	66		105ZN73	133.50.251	225
	105ZN12	106.70.222	66		105ZN73	133.50.256	79
	105ZN12	106.70.223	255		105ZN73	133.50.257	79
	105ZN12	155.02.042	69		105ZN73	133.50.258	79
	105ZN12	155.02.052	69		105ZN73	133.50.269	95
	105ZN12	155.02.062	69		105ZN73	133.50.270	95
	105ZN12	155.02.072	69		105ZN73	133.50.271	95
	105ZN12	155.02.080	69		105ZN73	133.50.278	107
	105ZN14	102.64.100	67		105ZN73	133.50.281	107
	105ZN14	123.08.141	67		105ZN73	133.50.283	244
	105ZN14	123.08.142	67		105ZN73	133.50.284	244
	105ZN14	123.08.143	67		105ZN73	133.50.285	244
	105ZN14	123.08.144	256		105ZN73	133.50.296	225
	105ZN14	125.86.303	237		105ZN73	133.50.297	224
	105ZN14	125.86.304	237		105ZN73	133.50.301	225
					105ZN73	133.50.305	80
					105ZN73	133.50.311	96

Index by Finish

Finish Description	Code	Item No.	Page	Finish Description	Code	Item No.	Page
BRONZE, OIL-RUBBED							
	105ZN73	133.50.312	96		107ST48	116.07.423	128
	105ZN73	133.50.319	224		107ST48	116.07.426	128
	105ZN73	133.50.325	85		107ZN08	106.59.410	186
	105ZN73	133.50.326	85		107ZN08	109.80.401	8
	105ZN73	133.50.331	264		107ZN08	151.54.400	48
	105ZN73	133.50.340	223		107ZN27	155.00.270	185
	105ZN73	133.50.341	223		107ZN27	155.00.660	208
	105ZN73	133.50.342	223	CHROME, POLISHED	107ZN38	151.36.222	187
	105ZN73	133.50.346	83		101AL32	155.01.840	26
	105ZN73	133.50.347	83		101AL32	155.01.841	27
	105ZN73	133.50.348	83		101AL32	155.01.842	27
	105ZN73	133.50.349	83		101AL32	155.01.843	26
	105ZN73	133.50.354	226		101AL32	155.01.844	27
	105ZN73	133.50.357	226		101AL32	155.01.845	26
	105ZN73	133.50.358	226		101AL32	155.01.860	27
	105ZN73	133.50.359	226		101AL32	155.01.861	26
	105ZN73	133.50.360	226		101AL32	155.01.862	27
	105ZN73	133.50.376	209		101AL32	155.01.863	27
	105ZN73	133.50.377	210		101AL32	155.01.864	27
	105ZN73	133.50.378	209		101AL32	155.01.865	27
	105ZN73	133.50.385	98		101AL32	155.01.871	27
	105ZN73	133.50.386	98		101AL32	155.01.880	54
	105ZN73	133.50.387	98		101AL32	155.01.881	54
	105ZN73	133.50.398	233		101AL37	108.94.223	32
	105ZN73	133.50.399	233		101AL37	108.94.228	32
	105ZN73	133.50.609	223		101AL37	112.81.273	32
	105ZN73	133.50.611	83		101AL37	112.81.278	32
	105ZN73	133.50.612	83		101AL38	106.04.001	180
	105ZN73	133.50.615	226		101AL38	106.04.011	180
	105ZN73	133.50.628	230		101AL38	106.04.064	179
	105ZN73	133.50.629	230		101AL38	106.04.074	179
	105ZN73	133.50.635	210		101AL38	106.04.084	178
	105ZN73	133.50.636	210		101AL38	106.04.094	177
	105ZN73	133.50.640	98		101AL38	106.04.104	176
	105ZN73	133.50.645	233		101AL38	106.04.114	175
	105ZN73	133.50.653	221		101AL38	106.04.124	174
	105ZN73	133.53.251	265		101AL38	106.04.134	173
	105ZN73	133.53.411	248		101AL40	132.15.230	53
	105ZN73	133.53.412	249		101BR50	116.39.259	134
	105ZN73	133.53.413	249		101BR64	121.88.260	240
	105ZN73	133.53.414	249		101BR69	136.06.212	11
	105ZN73	133.53.415	249		101BR69	136.76.205	11
	121ST23	116.07.118	127		101BR75	155.01.543	241
BRONZE, OIL-RUBBED/NICKEL, SATIN					101ME41	134.43.201	136
	206SS73	133.50.697	61		101SS73	133.53.434	149
	206SS73	133.50.698	61		101SS73	133.53.435	150
	206SS73	133.50.700	61		101SS73	133.53.436	150
	206SS73	133.50.701	61		101SS73	133.53.437	150
	206SS73	133.50.702	61		101SS73	133.53.438	150
	206SS73	133.50.710	61		101SS73	133.53.439	149
BRONZE, OLD					101ST23	155.00.820	119
	126BR19	116.61.100	216		101ST23	155.00.821	119
	126BR19	116.61.102	216		101ST23	155.00.822	119
	126BR19	116.61.107	259		101ST23	155.00.823	119
	126BR19	116.61.108	259		101ST23	155.00.921	127
	126BR19	125.82.100	215		101ST48	116.07.217	127
	126BR19	151.92.100	215		101ST48	116.07.224	127
CHROME, BRUSHED/SATIN					101ST48	116.07.227	127
	115BR50	116.39.464	122		101ST79	155.00.360	121
	115ME41	134.43.401	134		101ST79	155.00.361	121
	115ST48	116.07.417	127		101ST79	155.00.810	121
	115ST48	116.07.418	124		101ST79	155.00.811	121
	115ST48	116.07.424	127		101ST79	155.00.813	121
	115ST48	116.07.427	124		101ST79	155.00.816	121
	115ST48	116.07.443	122		101ST79	155.00.891	128
CHROME, MATT					101ST79	155.00.931	122
	107ME41	134.43.404	134		101ST79	155.00.932	122
	107ST08	117.25.401	131		101ZN07	106.69.205	24
	107ST08	117.26.400	131		101ZN07	106.69.207	24
	107ST23	155.00.833	116		101ZN07	106.69.276	113
	107ST23	155.00.835	116		101ZN07	106.69.277	113

Index by Finish

Finish Description	Code	Item No.	Page	Finish Description	Code	Item No.	Page
CHROME, POLISHED							
	101ZN08	104.33.200	7		101ZN49	155.01.930	161
	101ZN08	104.66.200	10		101ZN49	155.01.940	161
	101ZN08	106.59.210	186		101ZN49	845.05.200	273
	101ZN08	109.50.205	131		101ZN49	885.06.209	275
	101ZN08	110.22.201	186		101ZN73	133.50.134	204
	101ZN08	110.22.202	186		101ZN73	133.50.215	108
	101ZN08	116.22.236	134		101ZN73	133.53.416	248
	101ZN08	110.29.256	111		101ZN73	133.53.417	250
	101ZN08	110.29.259	111		101ZN73	133.53.418	250
	101ZN12	106.70.130	3		101ZN73	133.53.419	250
	101ZN12	155.02.240	28		101ZN73	133.53.420	250
	101ZN16	107.96.233	207		101ZN73	133.53.421	252
	101ZN16	107.96.234	207		101ZN73	133.53.422	252
	101ZN16	107.96.238	207		101ZN73	133.53.423	252
	101ZN22	108.76.231	13		101ZN73	133.53.424	252
	101ZN22	108.76.232	13		101ZN73	133.53.425	156
	101ZN22	108.76.233	13		101ZN73	133.53.426	156
	101ZN23	118.68.204	4		101ZN73	133.53.427	156
	101ZN23	103.30.205	4		101ZN73	133.53.428	156
	101ZN23	103.30.206	4		101ZN73	133.53.429	152
	101ZN23	110.35.390	4		101ZN73	133.53.430	152
	101ZN23	110.34.216	114		101ZN73	133.53.431	152
	101ZN23	110.34.227	6		101ZN73	133.53.432	152
	101ZN23	110.34.255	6		101ZN73	133.53.433	152
	101ZN23	110.34.265	48		101ZN73	133.53.440	145
	101ZN23	110.34.266	48		101ZN73	133.53.441	146
	101ZN23	110.34.286	68		101ZN73	133.53.442	146
	101ZN23	110.34.287	68		101ZN73	133.53.443	146
	101ZN23	110.35.271	6		101ZN73	133.53.444	146
	101ZN23	155.01.992	20		101ZN73	133.53.445	145
	101ZN23	155.02.002	20		101ZN73	133.53.446	101
	101ZN23	155.02.012	20		101ZN73	133.53.447	102
	101ZN26	104.96.251	208		101ZN73	133.53.448	102
	101ZN26	104.96.252	208		101ZN73	133.53.449	102
	101ZN26	136.81.210	208		101ZN73	133.53.450	101
	101ZN27	106.69.022	44		101ZN73	133.53.451	106
	101ZN27	106.69.032	45		101ZN73	133.53.452	106
	101ZN27	106.69.140	45		101ZN73	133.53.453	106
	101ZN27	106.69.141	45		101ZN73	133.53.454	106
	101ZN27	106.69.152	45		101ZN73	133.53.455	144
	101ZN27	106.69.162	44		101ZN73	133.53.456	144
	101ZN27	106.69.163	44		101ZN73	133.53.457	157
	101ZN27	106.69.280	28		101ZN73	133.53.458	157
	101ZN27	155.00.275	185		101ZN73	133.53.459	157
	101ZN27	155.01.784	51		101ZN73	133.53.460	257
	101ZN27	155.01.904	51	CHROME, POLISHED/GOLD	101ZN73	133.53.461	157
	101ZN27	155.01.914	51				
	101ZN27	155.01.924	51	CLEAR/BRONZE, BLACK	159BR59	117.44.200	68
	101ZN34	110.34.271	47				
	101ZN34	110.34.274	47		192AL73	133.53.124	78
	101ZN37	108.78.213	12		192AL73	133.53.125	78
	101ZN37	108.78.217	12		192AL73	133.53.126	78
	101ZN37	113.96.237	120		192ZN73	133.50.129	86
	101ZN38	102.47.301	16		192ZN73	133.53.127	75
	101ZN38	102.47.321	34		192ZN73	133.53.128	75
	101ZN38	102.47.331	34	CLEAR/BRONZE, GILDED	192ZN73	133.53.129	75
	101ZN38	102.47.341	34				
	101ZN38	102.47.351	33	CLEAR/BRONZE, OIL-RUBBED	193ZN73	133.50.130	86
	101ZN38	102.47.361	33				
	101ZN38	102.47.371	260		196AL73	133.50.117	77
	101ZN38	102.47.381	260		196AL73	133.50.118	77
	101ZN38	102.47.391	35		196AL73	133.50.119	77
	101ZN38	111.93.286	32		196ZN73	133.50.109	78
	101ZN38	113.97.210	55		196ZN73	133.50.131	86
	101ZN38	113.97.224	55		196ZN73	133.53.136	76
	101ZN38	113.97.227	55				
	101ZN38	113.97.246	54		196ZN73	133.53.137	76
	101ZN38	113.97.272	54	CLEAR/CHROME, POLISHED	196ZN73	133.53.138	76
	101ZN38	133.57.611	16				
	101ZN41	845.08.220	273		143ZN11	111.25.252	71
	101ZN49	125.61.251	243		143ZN11	111.25.262	71
					143ZN26	139.60.422	72

Index by Finish

Finish Description	Code	Item No.	Page	Finish Description	Code	Item No.	Page
CLEAR/GOLD, CHAMPAGNE	194AL73	133.50.111	77		187ZN73	133.50.375	209
	194AL73	133.50.112	77		187ZN73	133.50.382	97
	194AL73	133.50.113	77		187ZN73	133.50.383	97
	194ZN73	133.50.127	86		187ZN73	133.50.384	97
	194ZN73	133.53.130	86		187ZN73	133.50.618	39
	194ZN73	133.53.131	86		187ZN73	133.50.619	39
	194ZN73	133.53.132	86		187ZN73	133.50.626	231
					187ZN73	133.50.627	231
CLEAR/GOLD, POLISHED	178ZN26	138.72.800	72		187ZN73	133.50.633	210
					187ZN73	133.50.634	210
CLEAR/GUNMETAL	195ZN73	133.53.133	75		187ZN73	133.50.639	97
	195ZN73	133.53.134	76		187ZN73	133.53.057	220
	195ZN73	133.53.135	75		187ZN73	133.53.058	217
	195AL73	133.50.114	77		187ZN73	133.53.059	220
	195AL73	133.50.115	77		187ZN73	133.53.060	217
	195AL73	133.50.116	77		187ZN73	133.53.061	222
					187ZN73	133.53.062	222
CLEAR/NICKEL, POLISHED	197AL73	133.50.120	78		187ZN73	133.53.063	220
	197AL73	133.50.121	78		187ZN73	133.53.064	222
	197AL73	133.50.122	78		187ZN73	133.53.065	222
	197ZN73	133.50.132	86		187ZN73	133.53.066	264
	197ZN73	133.53.039	75		187ZN73	133.53.085	94
	197ZN73	133.53.040	75		187ZN73	133.53.086	94
	197ZN73	133.53.040	75		187ZN73	133.53.087	94
	197ZN73	133.53.139	76		187ZN73	133.53.088	94
					187ZN73	133.53.089	94
CLEAR/NICKEL, SATIN	198AL73	133.50.123	78		187ZN73	133.53.090	266
	198AL73	133.50.124	78		187ZN73	133.53.091	94
	198AL73	133.50.125	78		187ZN73	133.53.113	38
	198ZN73	133.50.110	78		187ZN73	133.53.114	38
	198ZN73	133.50.133	86		187ZN73	133.53.115	38
	198ZN73	133.53.140	76		187ZN73	133.53.116	262
	198ZN73	133.53.141	76		187ZN73	133.53.117	38
	198ZN73	133.53.142	76		187ZN73	133.53.151	200
					187ZN73	133.53.152	200
CLEAR/SILVER, ANTIQUE	191ZN73	133.50.108	78		187ZN73	133.53.153	200
CLEAR/STAINLESS STEEL	161SS36	103.79.401	72		187ZN73	133.53.154	200
	161SS36	135.73.400	72		187ZN73	133.53.155	200
COPPER, RUSTIC	134ZN08	105.61.014	196		187ZN73	133.53.156	200
	134ZN08	123.27.032	213		187ZN73	133.53.157	200
	134ZN08	123.31.031	213		187ZN73	133.53.158	268
	134ZN08	134.09.001	196		187ZN73	133.53.182	82
FROSTED/STAINLESS STEEL	144SS36	103.79.411	72		187ZN73	133.53.183	82
	144SS36	135.73.410	72		187ZN73	133.53.184	82
					187ZN73	133.53.185	82
GOLD, CHAMPAGNE	187ST73	133.50.657	140		187ZN73	133.53.186	82
	187ST73	133.50.658	140		187ZN73	133.53.187	265
	187ST73	133.50.659	139		187ZN73	133.53.188	82
	187ST73	133.50.660	140		187ZN73	133.53.204	263
	187ST73	133.50.661	139		187ZN73	133.53.218	100
	187ST73	133.50.662	139		187ZN73	133.53.219	100
	187ST73	133.50.663	139		187ZN73	133.53.220	100
	187ST73	133.50.678	140		187ZN73	133.53.221	100
	187ST73	133.53.055	269		187ZN73	133.53.222	267
	187ZN73	133.50.135	203				
	187ZN73	133.50.143	209				
	187ZN73	133.50.147	204				
	187ZN73	133.50.253	79				
	187ZN73	133.50.254	79				
	187ZN73	133.50.255	79				
	187ZN73	133.50.303	79				
187ZN73	133.50.323	85					
187ZN73	133.50.324	85					
187ZN73	133.50.365	230					
187ZN73	133.50.366	230					
187ZN73	133.50.368	230					
187ZN73	133.50.369	230					
187ZN73	133.50.373	209					
187ZN73	133.50.374	210					
				GOLD, CHAMPAGNE, FROSTED	200ZN73	133.50.100	40
					200ZN73	133.50.101	40
				GOLD, MATT			
					146AL38	106.04.002	180
					146AL38	106.04.012	180
					146AL38	106.04.020	57
					146AL38	106.04.030	57
					146AL38	106.04.040	58
					146AL38	106.04.050	57
					146AL38	110.52.440	137
					146AL38	110.52.450	137
					146AL38	110.52.460	137
					146AL38	110.52.470	138
					146AL38	110.52.480	138
					146ZN08	110.29.260	111
					146ZN08	110.29.261	111
					146ZN12	106.70.109	89

Index by Finish

Finish Description	Code	Item No.	Page	Finish Description	Code	Item No.	Page
GOLD, MATT	146ZN12	106.70.110	89		211ZN73	133.53.096	73
	146ZN12	106.70.111	89	MARBLE, WHITE/BRONZE, OIL-RUBBED	211ZN73	133.53.097	73
	146ZN12	106.70.123	89		213ZN73	133.53.034	74
	146ZN12	106.70.136	3		213ZN73	133.53.037	74
	146ZN12	106.70.160	66		213ZN73	133.53.038	74
	146ZN12	106.70.161	66		213ZN73	133.53.102	74
	146ZN12	106.70.162	66	MARBLE, WHITE/GOLD, CHAMPAGNE	212ZN73	133.53.098	74
	146ZN12	106.70.163	255		212ZN73	133.53.099	74
	146ZN12	106.70.172	66				
	146ZN22	108.76.241	14	MARBLE, WHITE/GOLD, CHAMPAGNE	212ZN73	133.53.100	74
	146ZN22	108.76.246	14		212ZN73	133.53.101	74
	146ZN22	108.76.251	14				
	146ZN35	110.22.080	9	MARBLE, WHITE/NICKEL, POLISHED	214ZN73	133.53.033	73
	146ZN35	110.22.081	9		214ZN73	133.53.035	73
	146ZN35	110.22.082	9		214ZN73	133.53.036	73
	146ZN38	102.47.302	16		214ZN73	133.53.103	73
	146ZN38	102.47.322	34				
	146ZN38	102.47.332	34	MARBLE, WHITE/NICKEL, SATIN	210ZN73	133.53.104	73
	146ZN38	102.47.332	34		210ZN73	133.53.105	74
	146ZN38	102.47.342	34		210ZN73	133.53.106	73
	146ZN38	102.47.352	33		210ZN73	133.53.107	74
	146ZN38	102.47.362	33				
	146ZN38	102.47.372	260	NICKEL, BLACK	131ST50	117.31.936	135
	146ZN38	102.47.382	260		131ZN49	134.45.308	135
	146ZN38	102.47.392	35		131ZN50	104.35.310	135
146ZN38	133.57.612	16					
146ZN49	845.01.540	275	NICKEL, BRUSHED BLACK		217ZN27	106.69.011	19
146ZN49	840.05.730	275		217ZN27	106.69.190	19	
146ZN96	101.69.504	19		217ZN27	106.69.191	19	
146ZN96	101.69.505	19		217ZN27	106.69.320	3	
				217ZN27	106.69.321	3	
GREY	215PL38	126.63.056	165	217ZN27	106.69.322	3	
	215PL38	126.63.057	165				
	215PL38	126.63.058	165				
GREY, MATT	215AL12	106.70.091	43	NICKEL, BRUSHED/SATIN	102AL12	155.02.025	123
	215AL12	106.70.201	43		102AL12	155.02.030	123
GUNMETAL	186ST73	133.50.655	269	102AL32	155.01.890	54	
	186ST73	133.50.664	142	102AL32	155.01.891	54	
	186ST73	133.50.665	141	102AL43	106.70.030	23	
	186ST73	133.50.666	142	102AL43	106.70.031	23	
	186ST73	133.50.667	141	102AL43	106.70.032	23	
	186ST73	133.50.668	142	102AL43	106.70.071	23	
	186ST73	133.50.669	142	102AL43	106.70.081	23	
	186ST73	133.50.670	141	102BR01	100.61.625	198	
	186ST73	133.50.679	141	102BR01	100.61.626	199	
	186ZN73	133.50.136	203	102BR01	100.61.627	198	
	186ZN73	133.50.266	95	102BR01	100.61.656	258	
	186ZN73	133.50.267	95	102BR01	116.36.606	258	
	186ZN73	133.50.268	95	102BR01	123.02.600	194	
	186ZN73	133.50.309	95	102BR01	123.02.631	198	
	186ZN73	133.50.310	95	102BR01	123.02.632	198	
	186ZN73	133.50.394	234	102BR01	151.40.603	194	
	186ZN73	133.50.395	234	102BR01	151.40.604	194	
	186ZN73	133.50.396	234	102BR01	151.40.607	194	
	186ZN73	133.50.620	39	102BR33	106.34.643	47	
	186ZN73	133.50.621	39	102BR33	161.16.600	8	
186ZN73	133.50.643	234	102BR75	155.01.571	10		
GUNMETAL/FROSTED	201ZN73	133.50.102	40	102BR75	155.02.150	194	
	201ZN73	133.50.103	40	102BR75	155.02.160	194	
GUNMETAL/NICKEL, POLISHED	204SS73	133.50.687	60	102BR75	155.02.260	194	
	204SS73	133.50.688	60	102SS73	133.50.705	62	
	204SS73	133.50.689	60	102ST23	155.00.901	127	
	204SS73	133.50.690	60	102ST51	134.41.001	128	
	204SS73	133.50.691	60	102ZN07	106.69.605	24	
	204SS73	133.50.708	60	102ZN07	106.69.607	24	
				102ZN07	106.69.676	113	
MARBLE, WHITE/BRONZE, BLACK	211ZN73	133.53.094	73	102ZN07	106.69.677	113	
	211ZN73	133.53.095	73	102ZN12	106.69.100	3	
				102ZN12	106.69.101	3	
				102ZN12	106.69.102	3	

Index by Finish

Finish Description	Code	Item No.	Page	Finish Description	Code	Item No.	Page
NICKEL, BRUSHED/SATIN	102ZN12	106.70.106	89	102ZN73	133.50.142	62	
	102ZN12	106.70.107	89	102ZN73	133.50.145	209	
	102ZN12	106.70.108	89	102ZN73	133.50.152	204	
	102ZN12	106.70.122	89	102ZN73	133.50.153	203	
	102ZN12	106.70.135	3	102ZN73	133.50.157	108	
	102ZN12	106.70.150	65	102ZN73	133.50.158	229	
	102ZN12	106.70.151	65	102ZN73	133.50.159	108	
	102ZN12	106.70.152	65	102ZN73	133.50.160	247	
	102ZN12	106.70.153	255	102ZN73	133.50.169	218	
	102ZN12	106.70.171	65	102ZN73	133.50.170	218	
	102ZN12	155.02.241	28	102ZN73	133.50.171	218	
	102ZN14	102.64.600	67	102ZN73	133.50.172	218	
	102ZN14	123.08.441	67	102ZN73	133.50.180	245	
	102ZN14	123.08.442	67	102ZN73	133.50.181	245	
	102ZN14	123.08.443	67	102ZN73	133.50.182	245	
	102ZN14	123.08.444	256	102ZN73	133.50.195	92	
	102ZN14	123.08.602	90	102ZN73	133.50.196	93	
	102ZN14	123.08.610	90	102ZN73	133.50.197	92	
	102ZN14	123.08.631	90	102ZN73	133.50.198	92	
	102ZN14	123.08.641	90	102ZN73	133.50.203	81	
	102ZN22	102.36.600	132	102ZN73	133.50.204	81	
	102ZN22	105.49.620	8	102ZN73	133.50.216	247	
	102ZN22	107.04.602	90	102ZN73	133.50.217	108	
	102ZN22	108.76.731	14	102ZN73	133.50.218	108	
	102ZN22	108.76.732	14	102ZN73	133.50.219	247	
	102ZN22	108.76.733	14	102ZN73	133.50.220	229	
	102ZN22	111.24.605	32	102ZN73	133.50.229	221	
	102ZN22	111.59.624	32	102ZN73	133.50.230	221	
	102ZN22	111.59.625	32	102ZN73	133.50.231	221	
	102ZN22	151.67.001	187	102ZN73	133.50.232	221	
	102ZN22	151.67.602	188	102ZN73	133.50.236	245	
	102ZN22	843.81.600	271	102ZN73	133.50.243	93	
	102ZN22	844.69.220	271	102ZN73	133.50.244	93	
	102ZN22	844.69.230	271	102ZN73	133.50.250	81	
	102ZN22	844.69.240	271	102ZN73	133.50.252	225	
	102ZN22	844.69.630	271	102ZN73	133.50.259	80	
	102ZN22	844.69.640	271	102ZN73	133.50.260	80	
	102ZN23	110.34.606	24	102ZN73	133.50.261	80	
	102ZN23	110.34.607	24	102ZN73	133.50.262	38	
	102ZN23	110.34.616	114	102ZN73	133.50.263	38	
	102ZN23	110.34.627	6	102ZN73	133.50.264	38	
	102ZN23	110.34.655	6	102ZN73	133.50.265	38	
	102ZN23	110.34.665	48	102ZN73	133.50.272	96	
	102ZN23	110.34.666	48	102ZN73	133.50.273	96	
	102ZN23	110.34.686	68	102ZN73	133.50.274	96	
	102ZN23	110.34.687	68	102ZN73	133.50.279	107	
	102ZN23	155.00.010	183	102ZN73	133.50.282	107	
	102ZN23	155.00.011	183	102ZN73	133.50.290	244	
	102ZN27	106.69.010	19	102ZN73	133.50.291	244	
	102ZN27	106.69.020	44	102ZN73	133.50.292	244	
	102ZN27	106.69.030	45	102ZN73	133.50.298	225	
	102ZN27	106.69.110	44	102ZN73	133.50.299	224	
	102ZN27	106.69.111	44	102ZN73	133.50.302	225	
	102ZN27	106.69.120	45	102ZN73	133.50.307	80	
	102ZN27	106.69.121	45	102ZN73	133.50.313	96	
	102ZN27	106.69.150	45	102ZN73	133.50.314	96	
	102ZN27	106.69.170	19	102ZN73	133.50.320	225	
	102ZN27	106.69.171	19	102ZN73	133.50.321	224	
	102ZN27	155.00.350	28	102ZN73	133.50.329	85	
	102ZN34	110.34.671	47	102ZN73	133.50.330	85	
	102ZN34	110.34.674	47	102ZN73	133.50.343	223	
	102ZN37	108.78.013	12	102ZN73	133.50.344	223	
	102ZN37	108.78.017	12	102ZN73	133.50.345	223	
	102ZN41	155.01.973	197	102ZN73	133.50.350	83	
	102ZN41	155.01.983	197	102ZN73	133.50.351	83	
	102ZN43	106.70.013	46	102ZN73	133.50.352	83	
	102ZN49	155.01.951	184	102ZN73	133.50.353	83	
	102ZN49	155.01.961	184	102ZN73	133.50.355	226	
	102ZN72	110.93.661	214	102ZN73	133.50.361	231	
	102ZN72	110.93.662	214	102ZN73	133.50.362	231	
	102ZN73	133.50.141	223	102ZN73	133.50.363	231	
				102ZN73	133.50.364	231	

Index by Finish

Finish Description	Code	Item No.	Page	Finish Description	Code	Item No.	Page
NICKEL, BRUSHED/SATIN							
	102ZN73	133.50.370	62		102ZN73	133.53.475	251
	102ZN73	133.50.371	62		102ZN73	133.53.476	251
	102ZN73	133.50.372	62		102ZN73	133.53.477	251
	102ZN73	133.50.379	209		102ZN73	133.53.478	251
	102ZN73	133.50.380	210		102ZN73	133.53.479	155
	102ZN73	133.50.381	209		102ZN73	133.53.480	155
	102ZN73	133.50.391	97		102ZN73	133.53.481	155
	102ZN73	133.50.392	97		102ZN73	133.53.482	155
	102ZN73	133.50.393	97		102ZN73	133.53.483	152
	102ZN73	133.50.603	234		102ZN73	133.53.484	152
	102ZN73	133.50.604	234		102ZN73	133.53.485	152
	102ZN73	133.50.605	234		102ZN73	133.53.486	152
	102ZN73	133.50.606	99		102ZN73	133.53.487	152
	102ZN73	133.50.607	99		102ZN73	133.53.494	145
	102ZN73	133.50.608	99		102ZN73	133.53.495	147
	102ZN73	133.50.610	223		102ZN73	133.53.496	147
	102ZN73	133.50.613	84		102ZN73	133.53.497	147
	102ZN73	133.50.614	84		102ZN73	133.53.498	147
	102ZN73	133.50.616	226		102ZN73	133.53.499	145
	102ZN73	133.50.624	39		102ZN73	133.53.500	101
	102ZN73	133.50.625	39		102ZN73	133.53.501	102
	102ZN73	133.50.630	231		102ZN73	133.53.502	102
	102ZN73	133.50.631	231		102ZN73	133.53.503	102
	102ZN73	133.50.632	72		102ZN73	133.53.504	101
	102ZN73	133.50.637	210		102ZN73	133.53.505	104
	102ZN73	133.50.638	210		102ZN73	133.53.506	104
	102ZN73	133.50.642	97		102ZN73	133.53.507	104
	102ZN73	133.50.649	234		102ZN73	133.53.508	103
	102ZN73	133.50.651	99		102ZN73	133.53.509	106
	102ZN73	133.50.654	221		102ZN73	133.53.510	106
	102ZN73	133.50.711	143		102ZN73	133.53.511	106
	102ZN73	133.53.003	264		102ZN73	133.53.512	106
	102ZN73	133.53.019	143		102ZN73	133.53.513	144
	102ZN73	133.53.020	143		102ZN73	133.53.514	144
	102ZN73	133.53.021	143		102ZN73	133.53.515	158
	102ZN73	133.53.093	266		102ZN73	133.53.516	158
	102ZN73	133.53.123	262		102ZN73	133.53.517	158
	102ZN73	133.53.167	202		102ZN73	133.53.518	158
	102ZN73	133.53.168	202	NICKEL, MATT	102ZN73	133.53.519	158
	102ZN73	133.53.169	202		103AL38	106.04.061	179
	102ZN73	133.53.170	202		103AL38	106.04.071	179
	102ZN73	133.53.171	202		103AL38	106.04.081	178
	102ZN73	133.53.172	202		103AL38	106.04.091	177
	102ZN73	133.53.173	202		103AL38	106.04.101	176
	102ZN73	133.53.174	268		103AL38	106.04.111	175
	102ZN73	133.53.196	265		103AL38	106.04.121	174
	102ZN73	133.53.212	263		103AL38	106.04.131	173
	102ZN73	133.53.228	267		103AL38	126.63.001	163
	102SS73	133.53.488	149		103AL38	126.63.005	163
	102SS73	133.53.489	148		103AL38	126.63.009	163
	102SS73	133.53.490	148		103AL38	126.63.013	163
	102SS73	133.53.491	148		103BR69	136.06.614	11
	102SS73	133.53.492	148		103BR69	136.76.610	8
	102SS73	133.53.493	149		103BR69	136.87.619	188
	102ZN38	102.47.300	16		103PL38	126.63.017	165
	102ZN38	102.47.320	34		103PL38	126.63.021	165
	102ZN38	102.47.330	34		103PL38	126.63.025	165
	102ZN38	102.47.340	34		103PL38	126.63.029	165
	102ZN38	102.47.350	33		103PL38	126.63.033	165
	102ZN38	102.47.360	33		103PL38	126.63.037	165
	102ZN38	102.47.370	260		103PL38	126.63.041	165
	102ZN38	102.47.380	260		103PL38	126.63.045	165
	102ZN38	102.47.390	35		103PL38	126.63.049	165
	102ZN38	133.57.610	16		103PL38	126.63.053	165
	102ZN73	133.53.467	103		103ST23	155.00.840	124
	102ZN73	133.53.468	103		103ST23	155.00.841	124
	102ZN73	133.53.470	248		103ST23	155.00.842	124
	102ZN73	133.53.471	248		103ST23	155.00.843	124
	102ZN73	133.53.472	248		103ST23	155.00.845	124
	102ZN73	133.53.473	248		103ST23	155.00.846	124
	102ZN73	133.53.474	248		103ST23	155.00.911	127

Index by Finish

Finish Description	Code	Item No.	Page	Finish Description	Code	Item No.	Page
NICKEL, MATT							
	103ST23	155.00.951	119		112ST73	133.50.674	136
	103ST23	155.00.952	119		112ST73	133.50.675	135
	103ST23	155.00.953	122		112ST73	133.50.676	136
	103ST23	155.00.954	122		112ST73	133.50.677	135
	103ST23	155.00.956	122		112ST73	133.50.680	136
	103ST38	116.07.631	126		112ZN08	103.06.700	188
	103ST38	116.07.664	132		112ZN08	134.09.730	188
	103ST48	116.07.624	128		112ZN14	102.64.700	63
	103ST48	116.07.627	128		112ZN14	123.08.746	63
	103ZN08	101.80.603	47		112ZN14	123.08.747	63
	103ZN08	103.05.620	195		112ZN14	123.08.748	63
	103ZN08	103.06.600	196		112ZN14	123.08.749	248
	103ZN08	104.33.600	7		112ZN23	118.68.704	5
	103ZN08	104.66.600	10		112ZN23	103.30.705	5
	103ZN08	104.80.600	8		112ZN23	103.30.706	5
	103ZN08	105.61.600	196		112ZN23	110.35.391	5
	103ZN08	110.20.603	114		112ZN35	103.29.711	67
	103ZN08	116.22.610	47		112ZN35	103.29.712	67
	103ZN08	116.22.638	123		112ZN35	132.19.710	67
	103ZN08	116.22.647	123		112ZN43	155.02.040	66
	103ZN08	134.09.633	196		112ZN43	155.02.050	66
	103ZN08	151.54.600	48		112ZN43	155.02.060	66
	103ZN13	105.63.600	15		112ZN43	155.02.070	66
	103ZN23	155.00.570	11		112ZN43	155.02.083	66
	103ZN23	155.01.991	20		112ZN73	133.50.138	195
	103ZN23	155.02.001	20		112ZN73	133.50.151	196
	103ZN23	15.02.011	20		112ZN73	133.50.176	238
	103ZN26	104.96.651	208		112ZN73	133.50.177	237
	103ZN26	104.96.652	208		112ZN73	133.50.178	238
	103ZN26	136.81.610	208		112ZN73	133.50.179	238
	103ZN27	155.00.240	183		112ZN73	133.50.191	88
	103ZN38	106.09.601	28		112ZN73	133.50.192	88
	103ZN38	109.57.602	8		112ZN73	133.50.193	88
	103ZN38	109.60.602	113		112ZN73	133.50.194	88
	103ZN38	109.60.603	113		112ZN73	133.50.201	77
	103ZN38	109.60.605	113		112ZN73	133.50.234	238
	103ZN38	109.60.625	113		112ZN73	133.50.235	237
	103ZN38	116.07.700	35		112ZN73	133.50.241	89
	103ZN38	116.07.701	35		112ZN73	133.50.242	89
	103ZN38	151.09.610	187		112ZN73	133.50.286	236
	103ZN41	104.37.600	90		112ZN73	133.50.287	236
	103ZN41	105.26.600	11		112ZN73	133.50.288	236
	103ZN41	105.34.602	28		112ZN73	133.50.289	236
	103ZN43	106.70.000	46		112ZN73	133.50.327	81
	103ZN49	104.09.600	208		112ZN73	133.50.328	81
	103ZN49	845.01.600	274		112ZN73	133.50.388	94
	103ZN49	845.05.600	273		112ZN73	133.50.389	94
	103ZN50	104.35.600	90		112ZN73	133.50.390	94
	103ZN56	845.01.620	274		112ZN73	133.50.601	225
	103ZN59	107.20.603	134		112ZN73	133.50.602	225
	103ZN73	133.50.275	36		112ZN73	133.50.622	35
	103ZN73	133.50.276	36		112ZN73	133.50.623	35
					112ZN73	133.50.641	94
NICKEL, POLISHED					112ZN73	133.50.647	225
	112BR01	100.61.704	198		112ZN73	133.53.022	192
	112BR01	100.61.705	199		112ZN73	133.53.067	212
	112BR01	100.61.707	198		112ZN73	133.53.068	209
	112BR01	100.61.717	258		112ZN73	133.53.069	212
	112BR01	155.02.153	193		112ZN73	133.53.070	209
	112BR01	116.35.256	194		112ZN73	133.53.071	211
	112BR01	116.36.206	258		112ZN73	133.53.072	211
	112BR01	123.02.700	185		112ZN73	133.53.073	212
	112BR01	123.02.710	185		112ZN73	133.53.074	212
	112BR01	123.02.721	190		112ZN73	133.53.075	211
	112BR01	123.02.722	190		112ZN73	133.53.076	256
	112BR01	151.40.203	185		112ZN73	133.53.092	258
	112BR01	151.40.204	185		112ZN73	133.53.118	33
	112BR01	151.40.207	185		112ZN73	133.53.119	33
	112ST73	133.50.656	259		112ZN73	133.53.120	33
	112ST73	133.50.671	135		112ZN73	133.53.121	254
	112ST73	133.50.672	136		112ZN73	133.53.122	33
	112ST73	133.50.673	135		112ZN73	133.53.159	194

Index by Finish

Finish Description	Code	Item No.	Page	Finish Description	Code	Item No.	Page		
NICKEL, POLISHED	112ZN73	133.53.160	194	NICKEL, POLISHED	142ZN12	155.02.071	65		
	112ZN73	133.53.161	192		142ZN12	155.02.084	65		
	112ZN73	133.53.162	192		142ZN27	155.01.783	48		
	112ZN73	133.53.163	194		142ZN27	155.01.903	48		
	112ZN73	133.53.165	194		142ZN27	155.01.913	48		
	112ZN73	133.53.166	260		142ZN27	155.01.923	48		
	112ZN73	133.53.189	78		142ZN35	116.60.200	49		
	112ZN73	133.53.190	78		142ZN35	116.60.201	49		
	112ZN73	133.53.191	78		142ZN73	133.50.146	196		
	112ZN73	133.53.192	78		142ZN73	133.50.183	88		
	112ZN73	133.53.193	78		142ZN73	133.50.184	87		
	112ZN73	133.53.194	255		142ZN73	133.50.185	88		
	112ZN73	133.53.195	78		142ZN73	133.50.186	87		
	112ZN73	133.53.205	224		142ZN73	133.50.205	104		
	112ZN73	133.53.206	224		142ZN73	133.50.237	87		
	112ZN73	133.53.207	224		142ZN73	133.50.238	87		
	112ZN73	133.53.208	224		142ZN73	133.50.277	103		
	112ZN73	133.53.209	224		142ZN73	133.50.280	103		
	112ZN73	133.53.210	224		SILVER, MATT	148ZN34	106.65.646	45	
	112ZN73	133.53.211	253			148ZN34	106.65.650	46	
	112ZN73	133.53.223	96		SLATE/GRAPHITE	208ZN12	106.70.185	39	
	112ZN73	133.53.224	96			208ZN35	110.22.050	7	
	112ZN73	133.53.225	96			208ZN35	110.22.086	7	
	112ZN73	133.53.226	96			208ZN35	110.22.089	7	
	112ZN73	133.53.227	257		STAINLESS STEEL	100AL03	155.01.632	171	
	NICKEL, POLISHED/CHROME, MATT	147ST38	152.00.727			179	100AL15	112.82.003	27
		147ST38	153.20.715			177	100AL15	112.82.004	27
NICKEL, POLISHED/FROSTED	203ZN73	133.50.104	36	100AL15		112.82.007	27		
	203ZN73	133.50.105	36	100AL15		112.82.010	27		
NICKEL, SATIN/BLACK	136BR28	151.12.606	181	100AL15		112.83.000	123		
				100AL15		112.83.002	124		
NICKEL, SATIN/FROSTED	207ZN73	133.50.106	36	100AL15		112.83.003	123		
				207ZN73		133.50.107	36	100AL15	112.83.004
PEWTER	104AL12	106.70.090	39	100AL15		112.83.006	123		
				100AL15	112.83.009	124			
				100AL15	112.83.010	123			
				100AL15	112.83.015	124			
				100AL15	112.83.015	124			
				100AL15	151.85.030	156			
				100AL15	151.86.030	156			
				100AL37	126.36.001	161			
				100AL37	126.37.001	161			
				100AL37	126.37.113	162			
				100AL37	126.37.123	162			
				100AL37	126.53.003	160			
				100AL40	110.46.084	24			
				100AL40	110.46.087	24			
				100AL40	126.14.605	24			
				100AL40	126.14.608	24			
				100AL40	132.15.630	49			
				100AL40	155.02.340	21			
				100AL40	155.02.341	21			
				100AL40	155.02.342	22			
				100BR64	121.88.662	232			
				100BR64	134.46.609	128			
				100BR64	137.42.606	232			
				100BR75	155.01.540	233			
				100ME41	134.43.601	128			
				100PL37	126.37.070	164			
				100PL37	126.37.071	164			
100PL37	126.37.074	164							
100PL37	126.37.075	164							
100PL37	126.37.096	164							
100PL37	126.37.097	164							
100PL37	126.37.098	164							
100SS22	100.51.025	182							
100SS30	155.01.450	114							
100SS30	155.01.451	114							
100SS30	155.01.452	114							
100SS30	155.01.453	114							
PEWTER, BRUSHED/SATIN	124ZN72	110.93.961	206	142ZN12	155.02.041	65			
	124ZN72	110.93.962	206	142ZN12	155.02.051	65			
PEWTER/COPPER	140ZN08	121.90.902	234	142ZN12	155.02.061	65			
	140ZN08	134.33.940	234						
SILVER, ANTIQUE									

Index by Finish

Finish Description	Code	Item No.	Page	Finish Description	Code	Item No.	Page
STAINLESS STEEL							
	100SS30	155.01.460	111		100ZN38	113.97.027	51
	100SS30	155.01.461	111		100ZN38	113.97.046	46
	100SS30	155.01.462	111		100ZN38	113.97.071	46
	100SS30	155.01.463	111		100ZN38	124.40.053	46
	100SS30	155.01.465	111		100ZN41	117.14.620	128
	100SS37	126.37.990	164		100ZN49	102.71.959	13
	100SS38	110.52.435	179		100ZN49	125.61.051	235
	100SS38	117.50.610	108		100ZN49	134.45.602	235
	100SS69	106.74.602	125		100ZN49	137.45.002	235
	100SS69	106.74.613	125		100ZN49	901.00.586	261
	100SS69	116.11.635	181	STAINLESS STEEL/NICKEL, POLISHED	100ZN78	103.78.026	86
	100SS69	116.11.644	181		205SS73	133.50.692	57
	100SS69	116.11.662	181		205SS73	133.50.693	57
	100SS69	116.11.671	181		205SS73	133.50.694	56
	100SS69	134.81.617	114		205SS73	133.50.695	55
	100SS69	134.81.626	114		205SS73	133.50.696	55
	100SS69	134.82.605	9		205SS73	133.50.709	56
	100SS69	134.83.602	9	UNFINISHED			
	100SS69	842.34.000	275		N/A	192.29.300	179
	100SS69	842.34.010	275		N/A	192.48.456	179
	100SS69	842.34.050	275		N/A	196.74.107	187
	100SS73	133.50.681	32	WHITE			
	100SS90	115.39.050	189		123NY62	116.71.100	121
	100SS90	115.39.051	189		123PL04	129.57.701	179
	100SS90	115.39.052	189		123ZN08	116.22.736	200
	100SS90	115.39.053	189		123ZN08	116.22.745	200
	100SS90	115.39.054	190	WHITE, RAL9010			
	100SS90	115.39.055	190		RAL9010	126.36.700	161
	100SS90	115.39.058	190		RAL9010	126.37.700	161
	100SS91	155.01.510	8		RAL9010	126.37.712	162
	100SS91	155.01.511	8		RAL9010	126.37.722	162
	100SS91	155.01.512	8		RAL9010	126.37.770	164
	100SS91	155.01.517	111		RAL9010	126.37.771	164
	100ST48	116.07.017	130		RAL9010	126.37.774	164
	100ST48	116.07.018	130		RAL9010	126.37.775	164
	100ST48	116.07.024	130		RAL9010	126.37.976	164
	100ST48	116.07.027	130		RAL9010	126.37.977	164
	100ST48	116.07.043	130		RAL9010	126.37.978	164
	100ST50	101.20.751	127	WHITE/CHROME, POLISHED	RAL9010	126.53.702	160
	100ST50	101.20.752	127		160ZN08	109.50.274	199
	100ST50	101.20.753	127		160ZN08	131.14.271	199
	100ST50	101.20.754	127				
	100ST50	101.20.755	127				
	100ST50	101.20.756	127				
	100ST50	101.20.757	127				
	100ST50	101.20.758	127				
	100ZN08	104.80.002	6				
	100ZN08	110.22.001	114				
	100ZN08	110.29.656	112				
	100ZN08	110.29.658	112				
	100ZN15	151.85.089	156				
	100ZN15	151.86.089	156				
	100ZN17	152.16.001	43				
	100ZN22	103.84.632	120				
	100ZN22	105.43.400	45				
	100ZN22	111.59.002	45				
	100ZN22	151.11.671	182				
	100ZN23	155.00.591	125				
	100ZN23	103.30.105	4				
	100ZN23	103.30.106	4				
	100ZN23	110.35.392	4				
	100ZN23	118.68.104	4				
	100ZN27	155.00.490	119				
	100ZN27	155.00.491	119				
	100ZN27	155.00.492	119				
	100ZN27	155.00.493	119				
	100ZN27	155.00.494	119				
	100ZN37	117.95.630	108				
	100ZN38	111.93.686	28				
	100ZN38	113.97.010	51				
	100ZN38	113.97.024	51				

EASIER TO ACCESS. EASIER TO USE.



We know you're always on the go and may not always be using a desktop or laptop to access our website. And that's exactly why our site has been updated with you in mind.

TRY IT
TODAY!

- Improved user experience on any device
- More robust, intuitive navigation
- Updated category displays include more information
- Login and shop on mobile, tablet, desktop or all three!

A NOTE ABOUT SUSTAINABILITY

Häfele America Co. strives to be a good corporate citizen by acknowledging that our actions — from how our products are sourced and manufactured to how we conduct our operations and beyond — have a direct impact on our local surroundings as well as the industries we serve. As part of those efforts our customers may notice fewer available printed copies of this catalog and a push toward digital access for product and technical information. You've already chosen to join us in business. Please also join us now in fostering responsible sustainability.

STANDARD TERMS AND CONDITIONS OF SALE

All purchases from Häfele America Co. are subject to the Terms and Conditions in effect at the time of shipment. Häfele's Terms and Conditions are set forth on its website, www.hafele.com, and are incorporated herein by reference. Should you not have access to the above web site and wish to obtain a printed copy of the Terms and Conditions, please contact your Häfele Sales Representative and a copy will be sent to you.

HÄFELE

HAF-DEC-2022

Häfele America Co. | 3901 Cheyenne Drive | Archdale, NC 27263

Phone: 800 423 3531 | **Fax:** 800 325 6197 | **Showrooms:** New York, Archdale, Los Angeles

www.hafele.com

© & TM Häfele GmbH & Co KG and/or Häfele America Co. Other trademarks referenced are owned by their respective owners. All rights reserved. Materials, designs and design elements shown herein may be the subject of US and International copyright and other forms of legal protection.